

CalSpas[®]

A Division of California Acrylic Industries, Inc.

CHANGING THE WAY YOU FEEL

Powered by GE Motors

1997

Pneumatic Controls Owner's Manual

Duplication without written consent is strictly prohibited.

1997 CAL SPAS

Pneumatic Owner's Manual

This owners manual is filled with valuable information that will help you in all steps of spa ownership. It will answer many questions you may have from general operation to weekly maintenance. We suggest you keep this manual accessible for quick reference as you walk through the various functions of your new CAL SPA.

If you have any questions after reviewing this manual, please contact your local Showroom/Dealership or call 1-800-CAL-SPAS. We have fully trained professionals who can walk you through any question or problem you may have.

Please take a minute to fill out the following information, it can save time when trying to identify your spa for service or answering troubleshooting questions.

Showroom / Dealer

Address

Telephone Number

Salesperson

Date purchased

Date Delivered

Spa Model

Spa Serial Number

Equipment Number

IMPORTANT SAFETY INSTRUCTIONS

When installing and using this electrical equipment, basic safety precautions should always be followed, including the following:

1. **Read and follow all instructions**
2. **Warning-**To reduce the risk of injury, do not permit children to use this product unless they are supervised at all times.
3. All 220 volt spas require **DEDICATED 50 AMP GFCI SERVICE WITH FOUR # 6 AWG COPPER WIRES** between the spa and the main breaker.
4. All 110 volt spas are provided with a GFCI on the end of the power cord. The GFCI should be tested before each use. (see page 4 for testing procedure)
5. **Danger-**Risk of Accidental Drowning. Extreme caution must be exercised to prevent unauthorized access by children. To avoid accidents, ensure that children cannot use a spa unless they are closely supervised at all times (Keep spa cover on when not in use).
6. **Danger-**Risk of injury. The suction fittings in this spa are sized to match the specific water flow created by the pump. Should the need arise to replace the suction fittings or the pump, be sure that the flow rates are compatible. Never operate spa if the suction fittings are broken or missing. Never replace a suction fitting with one rated less than the flow rate marked on the original suction fitting.
7. **Danger-**Risk of Electric Shock. Install at least 5 feet (1.5m) from all metal surfaces, as an alternative, a spa may be installed within 5 feet of metal surfaces if each metal surface is permanently connected by a minimum **No. 8 AWG** solid copper conductor to the outside of the spas control box.
8. **Danger-**Risk of Electric Shock. Do not permit any electrical appliance, such as a light, telephone, radio, television, within 5 feet (1.5m) of spa.
9. **Warning-**To reduce the risk of injury:
 - a.) The spa water should never exceed 104°F(40°C). Water temperatures between 100° (38°C) and 104°F (40°C) are considered safe for a healthy adult. Lower water temperatures are recommend for young children, and when spa use exceeds 10 minutes.
 - b.) Since excessive water temperatures have a high potential for causing fetal damage during early months of pregnancy, pregnant or possibly pregnant women should limit spa water temperatures to 100° (38°C) and not to exceed more than 10 minutes. (Always check with a physician)
 - c.) Before entering a spa, the user should measure the water temperature with an accurate thermometer, since the tolerance of water temperature-regulating devices varies.
 - d.) The use of alcohol, drugs, or medication before or during spa use may lead to unconsciousness with the possibility of drowning.
 - e.) Persons suffering from obesity or with a medical history of heart disease, low or high blood pressure, circulatory system problems or diabetes should consult a physician prior to spa use.
 - f.) Persons using medication should consult a physician before using a spa since some medication may induce drowsiness while other medication may affect heart rate, blood pressure, and circulation.

Save These Instructions

Basic Spa Information

Introduction:

Congratulations on the purchase of your new Cal Spa. Our purpose is to provide you with the most relaxing hot water massage you have ever encountered. In order to maximize the pleasure of your new spa, you will need to understand how it works.

Your new Cal Spa engineered with a high-powered water pump that pushes water through various therapy jets which will relax even the tightest of muscles. In addition to the water pressure, you can add air into the spa water with air venturies, to increase the intensity of your massage.

Do not be afraid to push buttons or turn knobs to learn about your new Cal Spa, as it is built with quality materials and excellent craftsmanship.

The following operating and maintenance instructions are very important, and must be followed carefully. With the proper care and maintenance, your Cal Spa will provide you with years of satisfaction and performance with minimum effort.

The filtering of your spa is very important, this alone will cut down cleaning time and use of excess chemicals. We recommend that your spa filters no less than two hours twice a day. The 220 models with time clocks, can be set to filter from 30 minutes to 24 hours. The models without time clocks will filter when in use or when the thermostat calls for heat.

The filter(s) need to be cleaned on a regular basis. We recommend that the filter is cleaned at least once a week. This is very simple and only takes a few minutes, and the result is increased water clarity and pump longevity. See the filter cleaning instructions on page 9 for more information.

The spas water level is also very important to the operation of your spa. If the water level is to low or to high your spa wont run or clean properly. (the water level should be just below the top of the Weir Skimmer area when no one is in the water.)

We recommend that your spa water is changed every 4 to 6 months. You may find the need to change your water more often with heavy use.

When empty your spa should be cleaned with a non abrasive cleaner, like "**Cal Spas All Surface Cleaner**," then rinsed thoroughly.

When refilling your spa, use regular tap water. **DO NOT USE SOFT WATER.** Soft water is not recommended for spa use for two reasons, The first is soft water is impossible to keep chemical levels balanced, which could result in spa damage. The other reason is soft water becomes very foamy hard to keep water clear.

NOTE: Spas built in the winter months will be delivered with the air relief valves removed from the pumps and taped inside or on top of the control box. We remove the air relief valve after water testing at the factory to prevent possible freeze damage during shipping. Prior to filling your spa for the first time, make sure you replace the air relief valves and check the equipment for any unions that might have loosened during shipping.

It is very important to keep the spa covered when not in use for two reasons. The first is heating efficiency, the spa will use less electricity in maintaining your set temperature, as well as protect your spas finish from the suns ultra violet rays.

Your spa's optional air blower should be used sparingly, When operating the air blower, water temperature drops quite rapidly and also dissipates chemicals.

In addition to your portable spa, you may have purchased a gazebo, cabana, steps or other redwood accessory. We recommend that you protect them by applying a high quality redwood protectant or sealer and repeat as specified on the directions.

110 Volt Information

Use only a dedicated circuit with a 20 amp breaker.

Always use a weatherproof/covered receptacle.

Never have your spa closer than 10 feet to the receptacle

In the event of a damaged cord you must replace it before next usage.

Do not bury the power cord.

All 110 volt spas include a GFCI plug. This GFCI plug should be tested prior to every use. To test the GFCI, please follow these easy instructions:

1. When the GFCI's is plugged into the aforementioned power supply, the spa will start to operate in about 5 seconds.
2. Press the button marked "Test" on the GFCI, the GFCI will click and the spa will stop operating.
3. Press the button marked "Reset" on the GFCI, the GFCI will click and the spa will turn back on in about 5 seconds.
4. The spa is now safe to use.

If the GFCI should turn off while the spa is in use (trip), press the reset button. If the GFCI will not reset, unplug the GFCI and call your local Showroom/Dealership for service.

Operation

1. Thermostat operates pump on low speed. Turn the thermostat up and the low speed pump and heater will come on and heat until set temperature is reached. *(Note: 110 volt spas only heats on low speed. When the spa is heating on low speed and the Jet button is pushed for high speed the heater will automatically turn off.)*
2. Press the Jet button on the topside control panel to turn the high speed pump and the Light on, press the Jet button again to turn the high speed pump and Light off.

Hi Limit Protection

Your spa is equipped with a high limit safety switch that will automatically shut down the spa in the unlikely event of an overheat situation. The Hi Limit reset button is located on the side of the control box. To reset the Hi Limit, simply push the button in until it stops, and the spa will restart itself.

110 / 220 Volt Convertible Information

To change units from 220 volt to 110 volt follow the instructions below.

*This Conversion must be done by a qualified electrician.

1. Remove 220 volt power lines. Line 1, Line 2, and the neutral wires from the main contractor.
2. Remove red cap from the neutral wire and install it in the original Line 2 position on the main contractor.
3. Install #12 AWG conductor cord with GFCI.
 - A. Connect power wire (Black) to Line 1 position on the main contractor.
 - B. Connect neutral wire (White) to line 2 position on the main contractor.
 - C. Connect ground wire (Green) to grounding lug.

110 Volt Electrical Requirements

20 amp Circuit Breaker

#12 Copper Wire

1 # 12 Black (Power)

1 # 12 White (Neutral)

1 # 12 Green (Ground)

GFCI Required

220 Volt Electrical Requirements

40 amp Circuit Breaker

#6 Copper wire

1 # 6 Black (Power)

1 # 6 Red (Power)

1 # 6 White (Neutral)

1 # 6 Green (Ground)

GFCI Required (220 Volt)

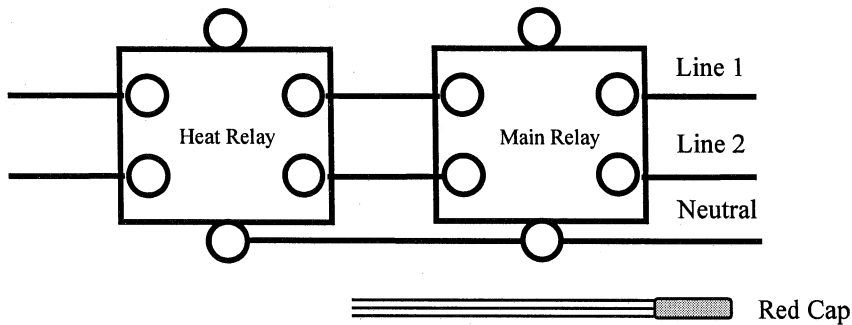

Operation

Thermostat operates pump on low speed. Turn the thermostat up and the low speed
(Note: 110 volt spas only heats on low speed. When the spa is heating on low speed and the Jet button is activated for high speed, the heater will automatically turn off.)

Press the Jet button on topside control panel to turn the high speed on, press the Jet button again to turn the high speed off.

Press the Light button to turn on the light, press Light button again to turn off the light.

Hi Limit Protection

Your spa is equipped with a high limit safety switch that will automatically shut down the spa in the unlikely event of an overheat situation. The Hi Limit reset button is located on the side of the control box. To reset the Hi Limit, simply push the button in until it stops, and the spa will restart itself.

220 Volt Information

All 220 volt spas are required to have a GFCI breaker and should only be wired by a licensed electrician. To ensure proper wiring of your GFCI please follow the wire diagram at the bottom of this page.

Your new 220 volt CAL SPAS requires a **DEDICATED 50 AMP GFCI SERVICE WITH # 6 AWG COPPER WIRES**. This will include a black and red wire for your incoming power, a white wire used for your neutral and a green number wire for your ground.

Before each use of your spa check the GFCI. During this test the spa should be operating.

1. Press the test button on the GFCI. The GFCI will click and the spa will shut off.
2. Wait 30 seconds and reset the GFCI breaker, this is done by turning the breaker off and then back on. Your spa will be operational in about 5 seconds.
3. Your spa is now safe to use.

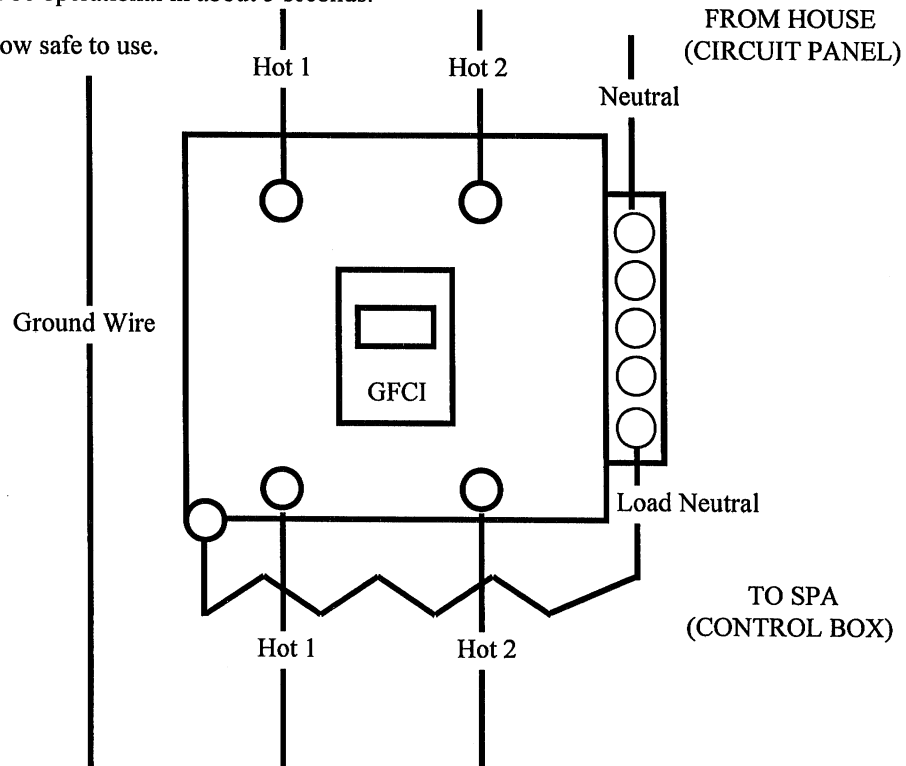

Hi Limit Protection

Your spa is equipped with a high limit safety switch that will automatically shut down the spa in the unlikely event of an overheat situation. The Hi Limit reset button is located on the front side of the control box. To reset the Hi Limit, simply push the button in until it stops, and the spa will restart itself.

Set-Up and Delivery Guidelines

Getting Ready For Delivery and Set-up of Your New Cal Spa

Your 110 volt spa pack requires an isolated (no other appliances or lights on this circuit at any time) 110 volt, 20 amp circuit breaker cords maximum length 15 feet.

Extension cords are not to be used in conjunction with operation of the spa. Low voltage damage could result, which is not covered by your warranty.

Your 220 volt spa will require a 50 amp dedicated circuit breaker.

If you have any doubts, have your electrical system checked by a qualified electrician.

Surface and Pad Requirements

Your new portable spa must be placed on a uniformly firm, flat and level concrete pad. We recommend a 3½" thick slab.

If the location of your spa is going to be near a sprinkler system, make sure you adjust the sprinkler heads away from the spa. Water continually sprayed on spa cabinet or in equipment area may cause wood or electrical component damage.

Requirements for Decking, Gates and Balconies:

All decking must be able to support 150 pounds per square foot.

Surrounding area gates must be self closing and self latching (California Requirements).

Balconies must be constructed to current state and local code. (Spa load requirements are 150 pounds per square foot)

General Operation Instructions

One and Two Button Panels

Different models have different control panels. Most 110 Volt spas have a one button panel and the 220 Volt spas have a two or three button panel. Both panels function the same way, simply push the button down with a quick/sharp push, once to turn on a particular function and again to turn that function off.

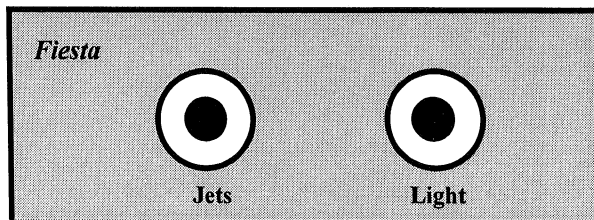
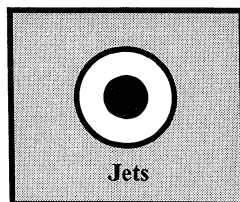

Air Venturies: Air Venturies are the small knobs located around the of your spa . These knobs will let you to add a mixture of air in with the jet pressure.

Adjustable Jets: Almost all jets are adjustable. These jets just require a turn from the left to the right to either turn that jet on or off.

Priming The Pump

Its is important to make sure that all the air is out of the equipment pack prior to operating your new Cal Spa. To do this, simply follow the steps below.

1. Turn power off at the breaker. (110 Volt spas, unplug)
2. Open all the Gate Valves (Up = Open)
3. Fill the spa to the proper water level with Regular Tap Water. (½ way up on weir skimmer area)
4. Open air relief valve, located on the front of the pump.
5. After air bubbles stop coming out of the air relief valve, tighten valve until closed.
6. Turn power on at breaker. (110 Volt spas, plug in to 20 amp service)
7. Rotate thermostat knob into the HOT area on the control box.
8. Allow the spa to run up to five minutes. If water does not start to circulate, repeat steps 1 through 7.

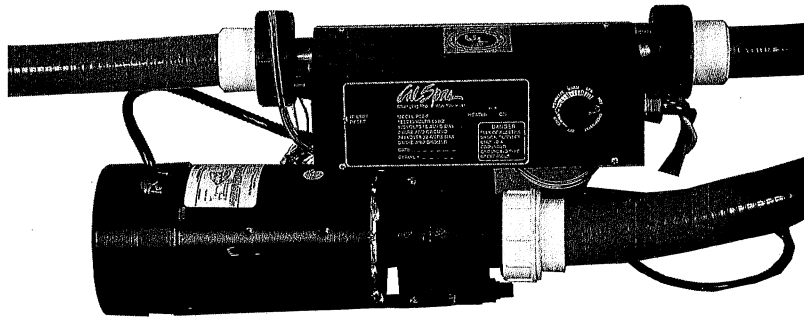

Important Notes:

Be careful not to over tighten the air relief valve.

Never run spa with gate valves closed.

Never leave the pump on for more than five minutes without water circulating.

Filter Maintenance

Your new Cal Spa will filter the water while heating and during normal spa use. As the flow of water goes through the filter, dirt and debris is removed and accumulated in the filter cartridge. As the filter accumulates more and more dirt and debris, water flow is lessened and jet performance is reduced. **This can cause you spa not to run or heat properly.**

Clean Your Filter Regularly, and Replace As Needed.

Filter Cleaning

Your new Cal Spa has been designed for quick and easy filter maintenance. The filter cartridge should be cleaned once a week using the following steps.

1. Turn power off at the breaker.
2. Remove filter cover.
3. Remove filter basket.
4. Remove filter, (Pull-Out) and clean with a garden hose.
 - a. Hold filter vertically.
 - b. Spa filter cartridge with a pressure nozzle.
 - c. Turn filter cartridge and repeat step b.
 - d. reinstall filter cartridge in reverse order of removal.

Timer Operation

220 Spas Only (Non Convertible)

The time clock will turn on or off the low speed pump at the time you have selected. This is when the spa water is filtered and heated.

The spa water will heat to the temperature set on the thermostat , provided you have enough time set on the time clock. *(Note: 220 Volt Spa covered will heat approximately 5° to 7°F an hour.)*

To set time clock for time of day and desired filtration time, follow the steps below.

Setting time of day

1. Rotate time clock clockwise until the correct time of day is pointed to by the arrow on the face of the clock.

Setting Filtration time

1. Pull up tabs along the outside of the clock. Each tab in the up position is about 30 minutes of filtration time.
2. Recommended filtration time is 2 hours twice a day. This would equal a total of 4 tabs every 12 hours.

Winterizing and Draining Your Cal Spa

Winterizing

In many areas of the country the temperature drops below 32°F. If you live in these areas, it is our recommendation that you always have your spa full of water and running at normal spa temperatures. This will help reduce the risk of freezing in your spa and your spa's equipment.

IMPORTANT WARNING

If you find the need to drain your spa, please be aware of the potential of freezing in your spa's equipment and plumbing. Even if the directions below are followed perfectly, there is no guarantee that your spa will not suffer freeze damage.

Cold Climate Draining

1. Open all filters and filter baskets.
2. Remove filter(s).
3. Drain your spa completely.
4. Remove drain plugs from the front of pump(s)
5. Disconnect the unions from both sides of the pump(s)
6. Use a wet/dry vacuum to blow any remaining water out of the jets and plumbing lines.
7. Use a soft towel to remove any remaining water in the spa, filter canister, and equipment area.
8. Cover your spa with a good spa cover and a all weather tarp, to ensure rain and snow can not enter the spa.
9. If you have a **Gas Heater**, You will need to follow the winterizing instructions for your particular heater in the heater manufacturer's owner's manual. This manual will be delivered inside the your gas heater.

Warm Climate Draining

Your spa should be drained ever 4 to 6 months and refilled with fresh tap water. Here is how we recommend you drain your spa.

1. Turn off power.
2. Open all filters and filter baskets.
3. Remove filter(s).
4. Drain your spa completely using a garden hose attached to the drain fitting. This fitting is located inside the equipment area.
5. Once spa is completely drained, remove garden hose and replace the cap on the drain fitting.

Note: Prevent drain water from coming in contact with fragile shrubs and foliage.

One Button Control Panel
110 Volt Controls

Start up

When first powered up, the spa will run and heat to whatever temperature the thermostat is positioned to.

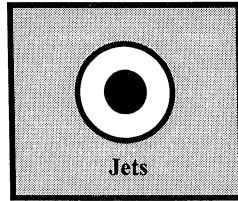

Temperature Adjustment

Rotate the thermostat knob from OFF to HOT to find desired water temperature. Range of water temperature will be from OFF to 104°F in the HOT position.

When temperature is set, the pump will run on low speed and heat until the set temperature is reached. Once the set temperature is reached, the pump and heater will come on in low speed any time the spa loses water temperature.

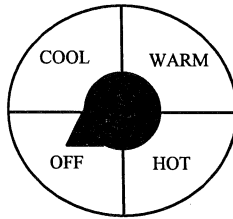

Jet Controls

Press the **Jet** button to activate the high speed pump and Light. Press the **Jet** button again to turn off the high speed pump and Light.

Filter Cycles

Your Spa will automatically filter itself any time the spa is heating or **Jet** button is pressed.

Hi Limit

Your spa is equipped with a high limit safety switch that will automatically shut down the spa in the unlikely event of an overheat situation. To reset the Hi Limit, simply push the button in until it stops, and the spa will restart itself.

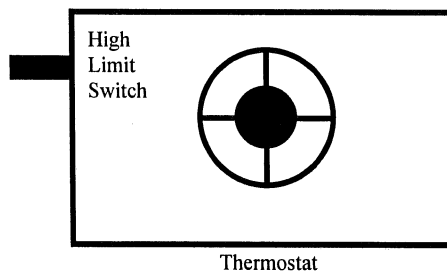

Two Button Panel

Fiesta Controls

Start up

When first powered up, the spa will run and heat to whatever temperature the thermostat is positioned to.

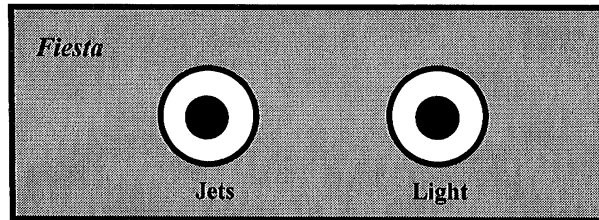

Temperature Adjustment

Rotate the thermostat knob from OFF to HOT to find desired water temperature. Range of water temperature will be from OFF to 104°F in the HOT position.

When temperature is set, the pump will run on low speed and heat until the set temperature is reached. Once the set temperature is reached, the pump and heater will come on in low speed any time the spa loses water temperature.

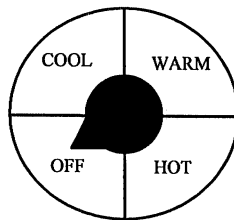

Jet Controls

Press the **Jet** button to activate the high speed pump. Press the **Jet** button again to turn off the high speed pump.

Light

Press the **Light** button to turn on the light. Press the **Light** button again to turn off the light.

Filter Cycles

Your Spa will automatically filter itself any time the spa is heating or **Jet** button is pressed.

Hi Limit

Your spa is equipped with a high limit safety switch that will automatically shut down the spa in the unlikely event of an overheat situation. To reset the Hi Limit, simply push the button in until it stops, and the spa will restart itself.

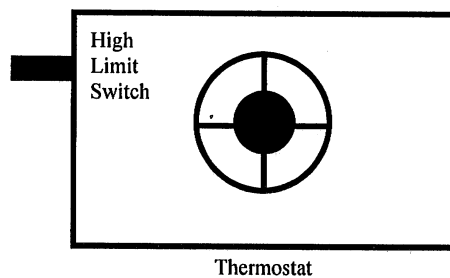

Three Button Panel

Supra Controls

Start up

When first powered up, the spa will run and heat to whatever temperature the thermostat is positioned to.

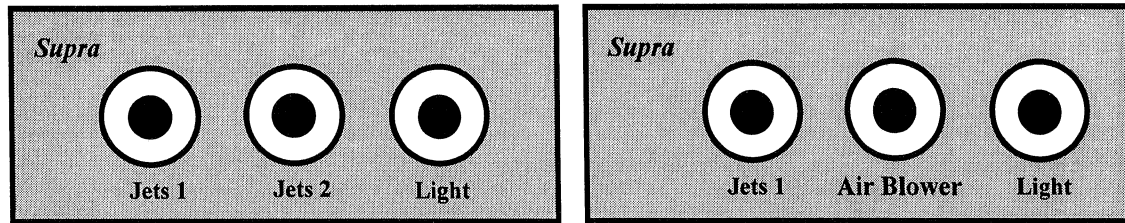

Temperature Adjustment

Rotate the thermostat knob from OFF to HOT to find desired water temperature. Range of water temperature will be from OFF to 104°F in the HOT position.

When temperature is set, the pump will run on low speed and heat until the set temperature is reached. Once the set temperature is reached, the pump and heater will come on in low speed any time the spa loses water temperature.

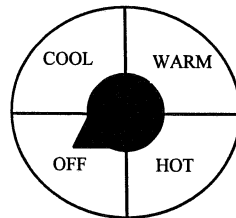

Jet Controls

Press the **Jet** button to activate the high speed pump. Press the **Jet** button again to turn off the high speed pump.

Light

Press the **Light** button to turn on the light. Press the **Light** button again to turn off the light.

Freeze Protection / Time Clock

This switch will either maintain the spa water temperature on the Freeze Protection side, or only heat during the length of time you set on the time clock.

Filter Cycles

Your Spa will automatically filter itself any time the spa is heating or **Jet** button is pressed.

Hi Limit

Your spa is equipped with a high limit safety switch that will automatically shut down the spa in the unlikely event of an overheat situation. To reset the Hi Limit, simply push the button in until it stops, and the spa will restart itself.

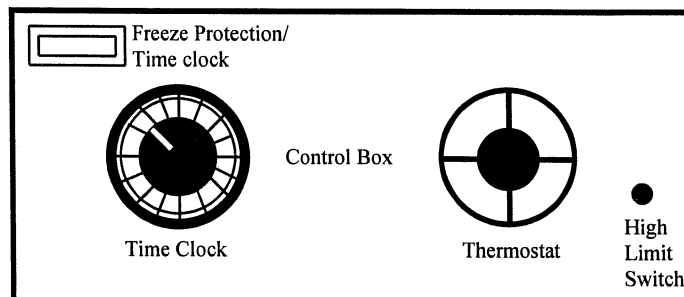

Trouble Shooting Guide

Low Water Pressure

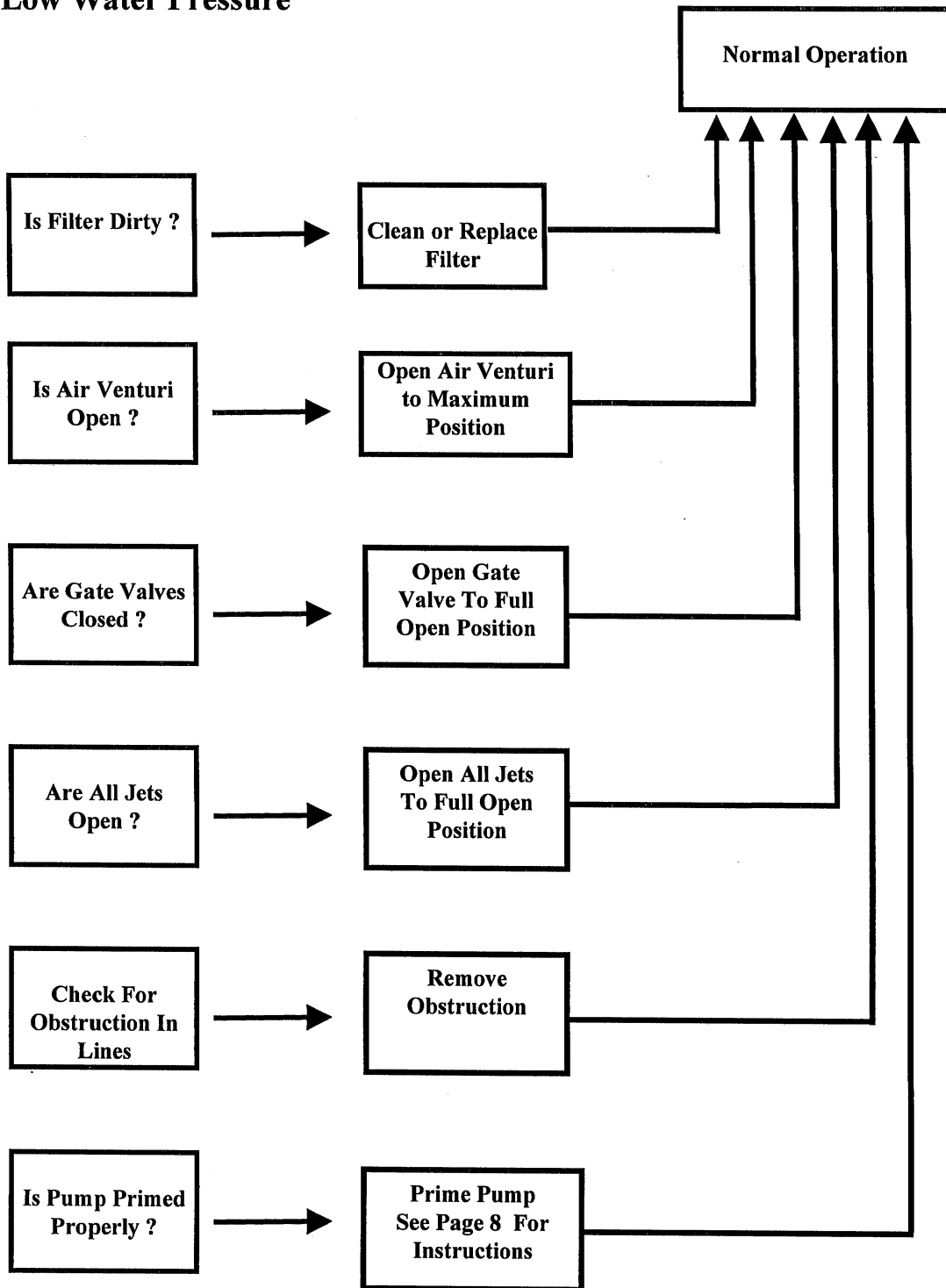

Trouble Shooting Guide

Jets Won't Work

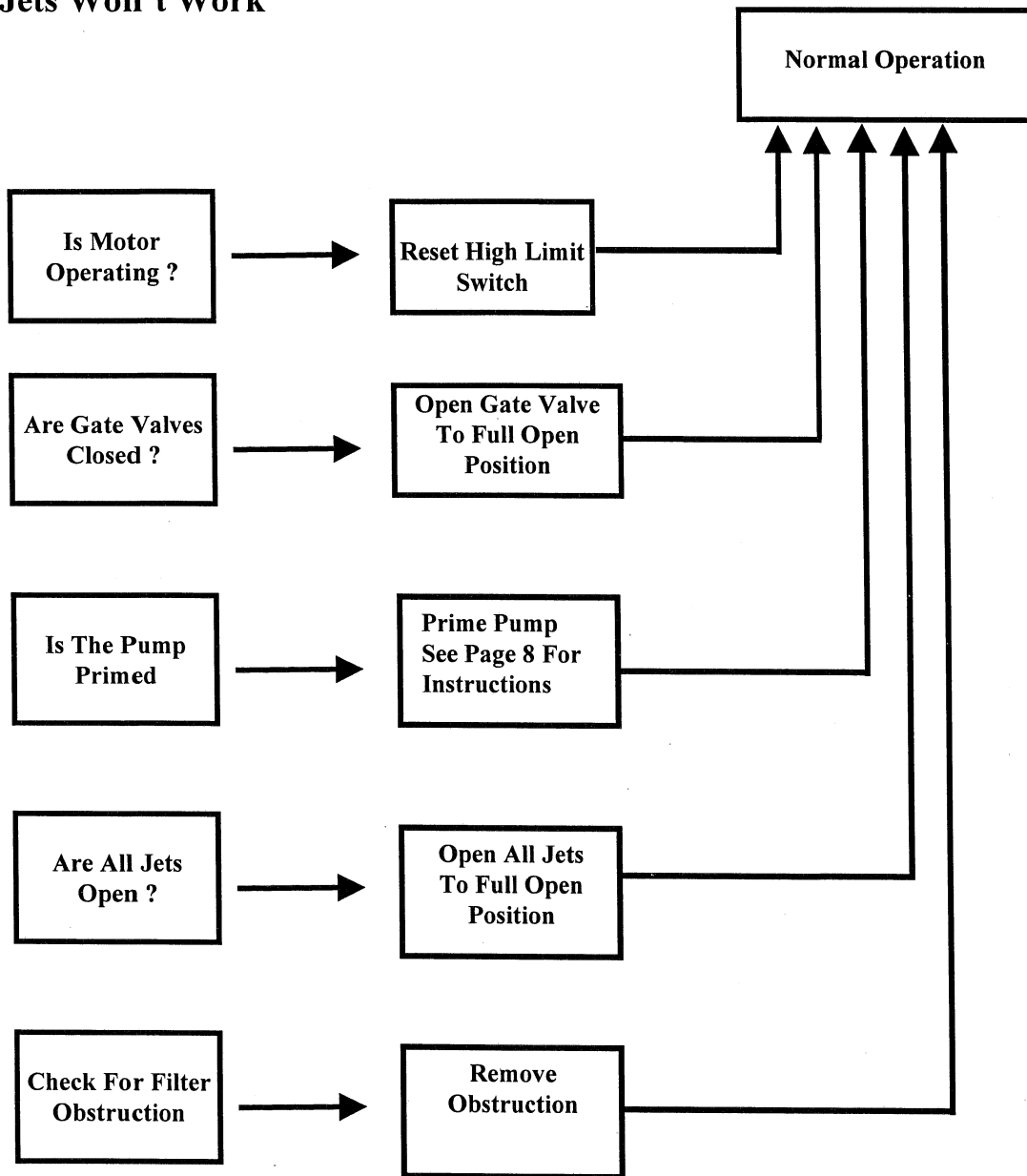

Trouble Shooting Guide

Pump Will Not Prime

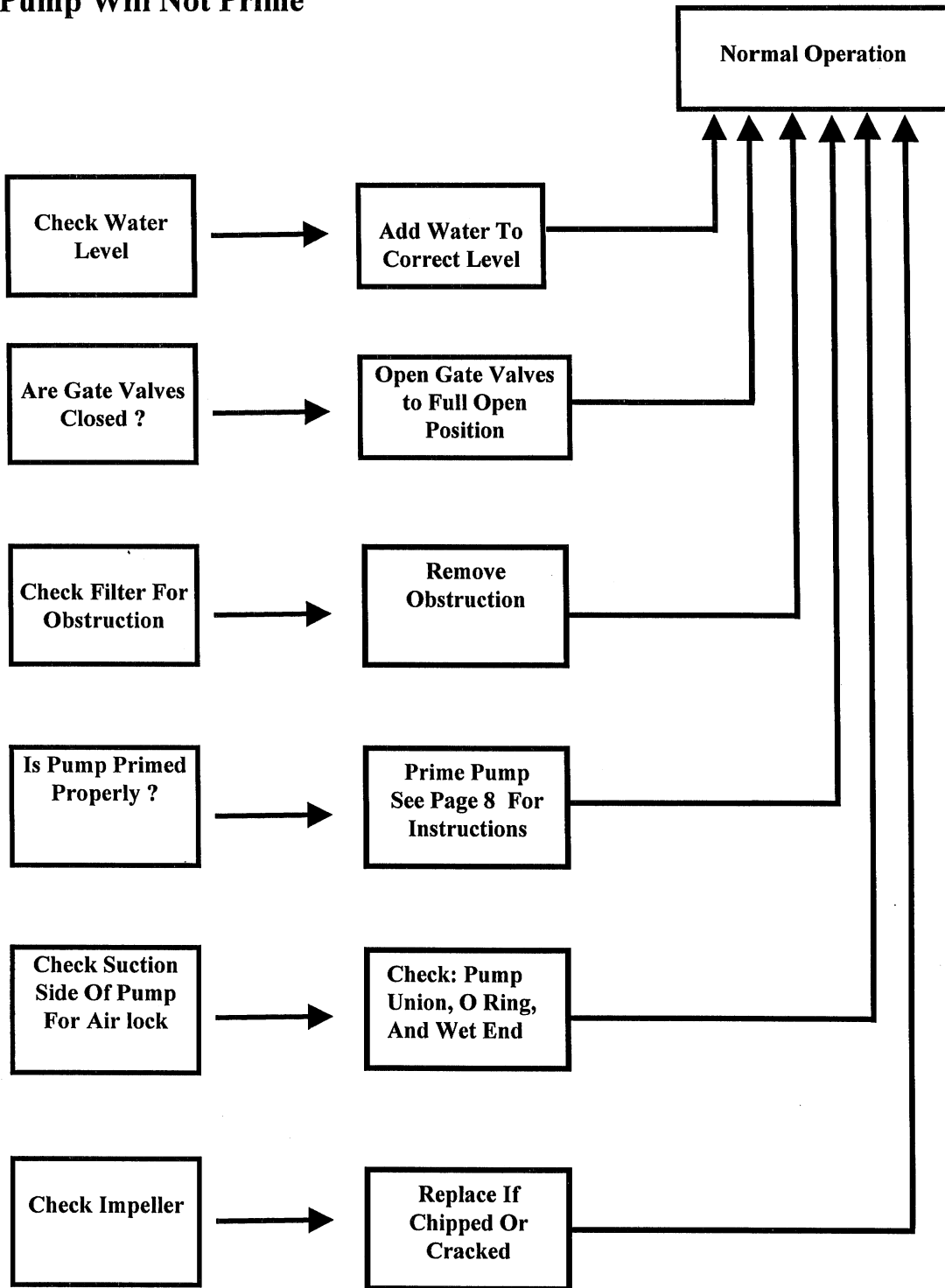

Trouble Shooting Guide

Motor Not Operating

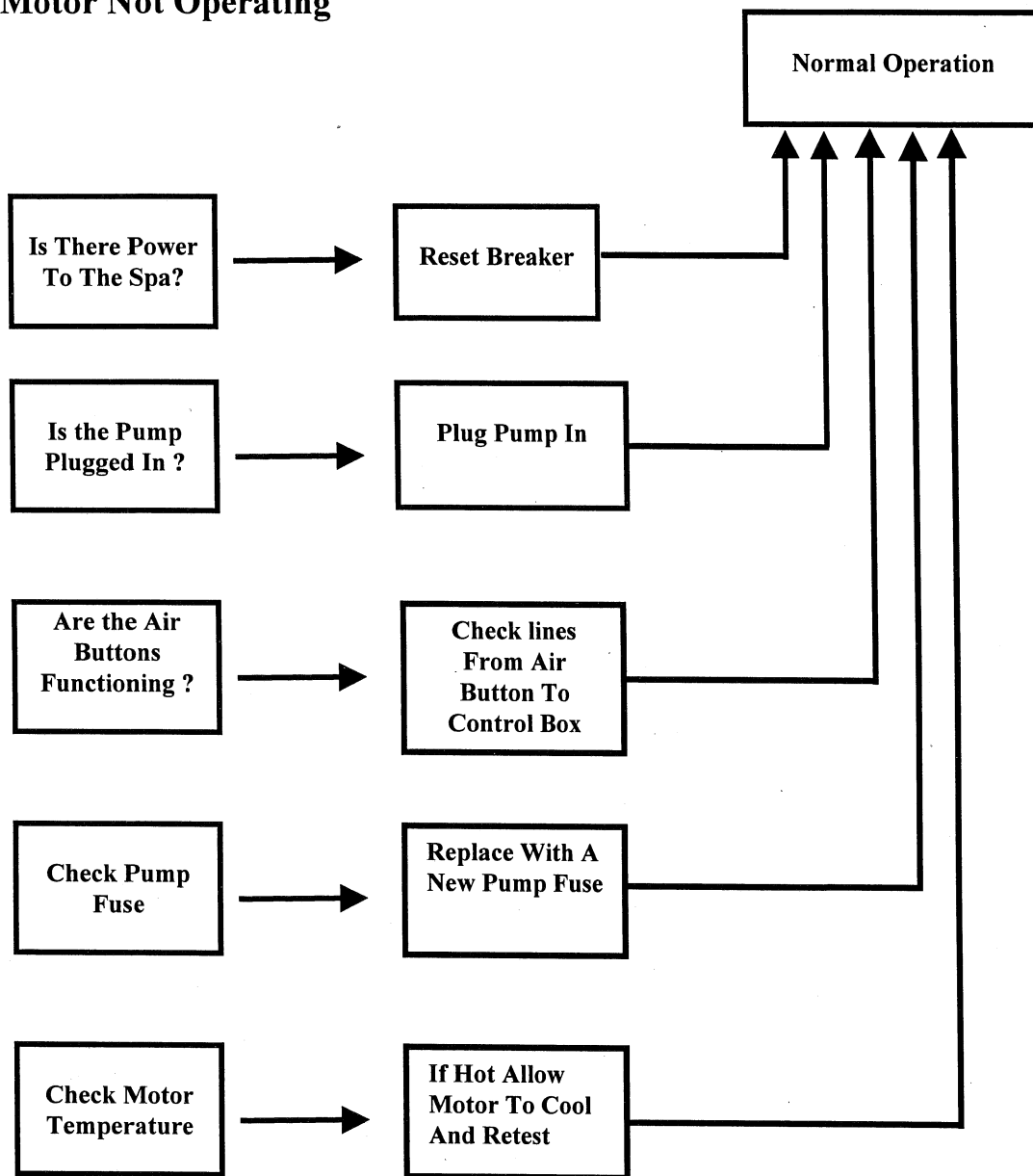

Trouble Shooting Guide

Motor Overheat / Or Shutdown

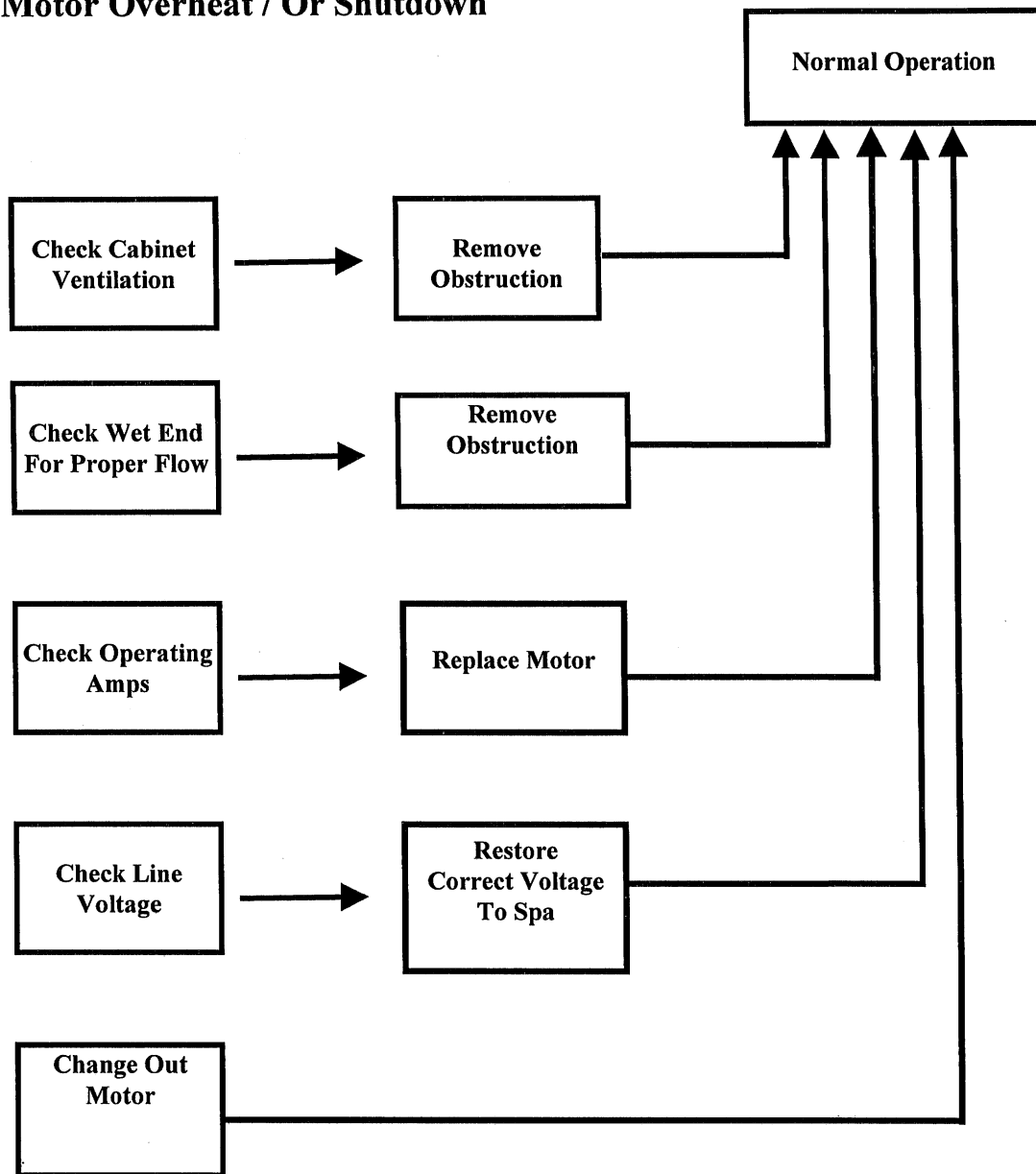

Trouble Shooting Guide

No Heat Or Low Heat

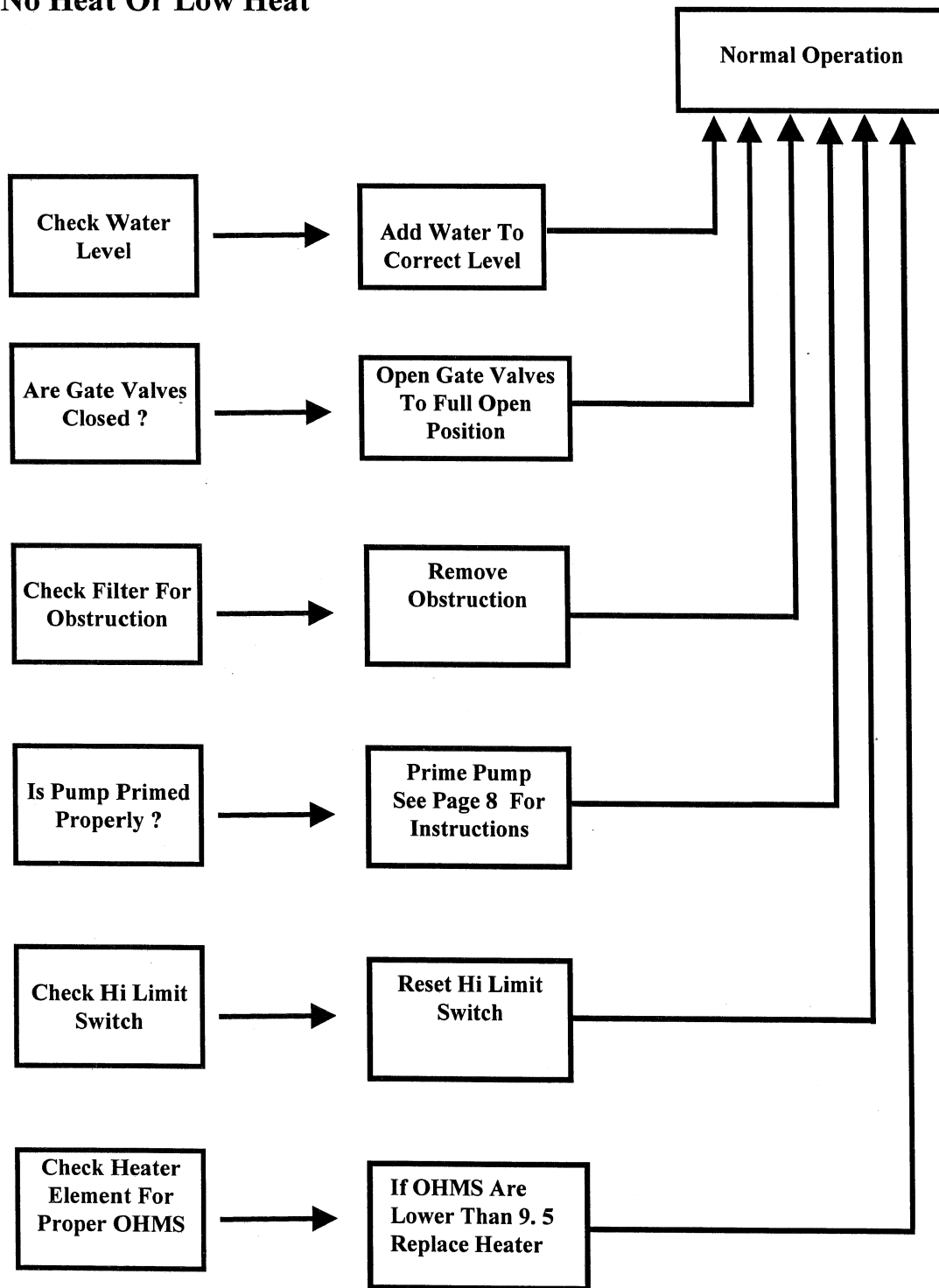

Trouble Shooting Guide

Ozone Machines

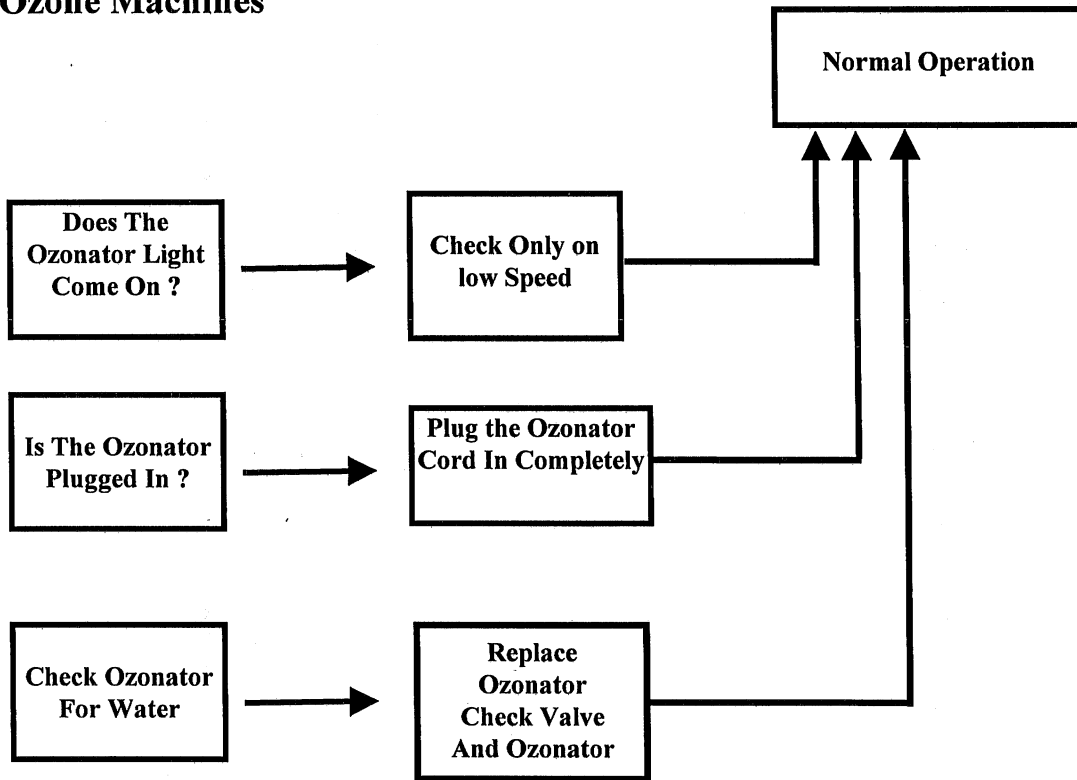

Trouble Shooting Guide

Internal Leak

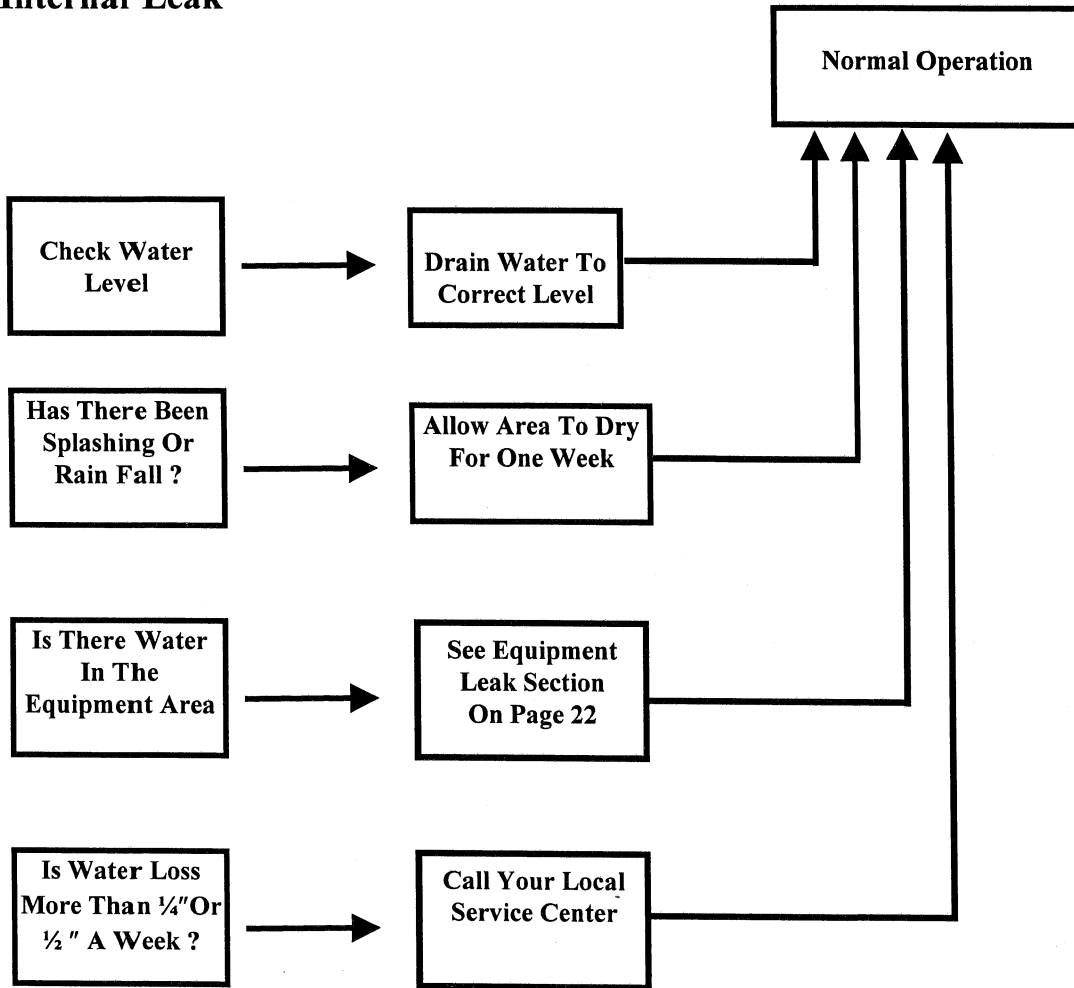

Trouble Shooting Guide

Equipment Leak

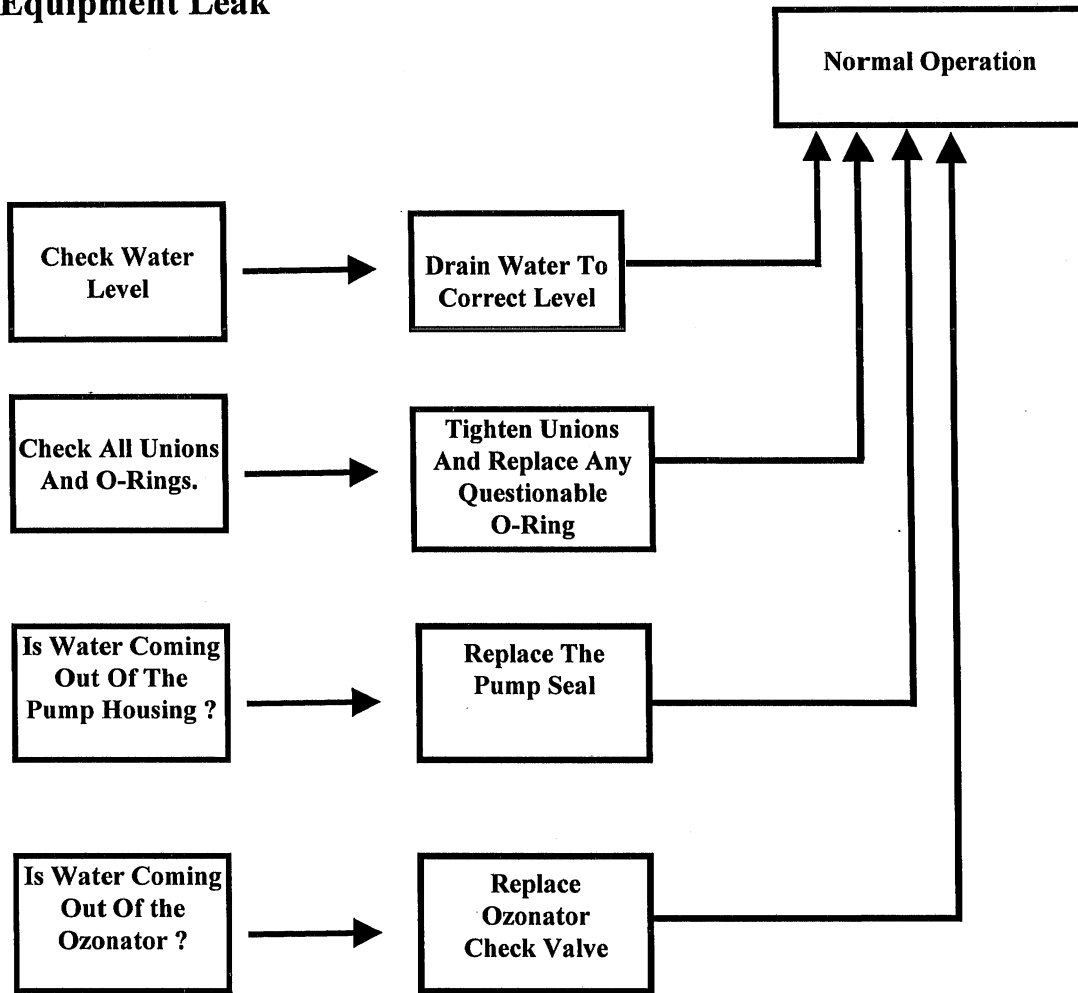

Cal Spas[®]

A Division of California Acrylic Industries, Inc.

CHANGING THE WAY YOU FEEL

Powered by GE Motors

**Call Cal Spas Parts Department
For Cal Spas Genuine Replacement Parts!**

**Cal Spas, the world's largest spa company,
stocks thousands of Genuine Cal Spas
Replacement Parts for any year or model Cal Spa.**

**1-800-CAL-SPAS
Fax: 909-865-7942**

**Cal Spas
1462 East Ninth Street
Pomona, CA 91766
www.calspas.com**

CAL SPAS

SHOWROOM LISTING

ATLANTA

Phone: (770) 446-7727
Fax: (770) 446-1548
SM: Tom Jenkins
DM: Steve Matthews
Address: 6588 Dawson Bl
Norcross, GA 30093

BAKERSFIELD

Phone: (805) 396-0811
Fax: (805) 396-1435
SM: Erick Johnson
DM: Joe Krebs
Address: 2700 Auto Mall Dr
Bakersfield, CA 93313

CHADDS FORD

Phone: (610) 459-4566
Fax: (610) 459-4403
SM: David Robertson
DM: Christine Samuelson
Address: 85 Baltimore Pike Rd 3
Chadds Ford, PA 19317

CHATSWORTH

Phone: (818) 718-9200
Fax: (818) 718-9480
SM: Randy Dumont
BM: Bob
Address: 9710 Topanga Cyn Bl
Chatsworth, CA 91311

CONCORD

Phone: (510) 676-1191
Fax: (510) 676-1477
SM: Mike McGovern
DM: Dave Kirby
Address: 5750 Imhoff Dr, Ste G
Concord, CA 94520

FAIRFIELD

Phone: (707) 422-7727
Fax: (707) 426-5492
SM: Joe McGuire
Address: 1595 Holiday Inn
Fairfield, CA 94533

LAS VEGAS

Phone: (702) 364-0246
Fax: (702) 364-0915
Whse: (702) 257-7680
Fax: (702) 257-7691
SM: Barry Feingold
DM: Dick Lathrop
Address: 3002 Rancho Rd
Las Vegas, CA 89102

ONTARIO

Phone: (909) 947-7727
Fax: (909) 947-5087
SM: Frank Camarena
BM: Christina Convor
Address: 2330 S Vineyard Ave
Ontario, CA 91761
Christina's Pager: 514-2241

RENO

Phone: (702) 348-1500
Fax: (702) 348-1557
DM: Casey Clark
Address: 961 Matley Ln, #150
Reno, NV 89502

SACRAMENTO

Phone: (916) 366-0300
Fax: (916) 366-0389
SM: Albert Francis
DM: Ken Gorges
Address: 9618-B Business Park
Sacramento, CA 95827

WAREHOUSE

Phone: (916) 366-7727
Fax: (916) 366-1640
Address: 9613 Oates Dr
Sacramento, CA 95827

SAN BERNARDINO

Phone: (909) 888-7888
Fax: (909) 884-9984
SM: Jim Ginty
BM: Rick Ives
Address: 414 Redlands Blvd
San Bernardino, CA 92408

SPOKANE

Phone: (509) 483-6461
Fax: (509) 483-8108
SM: Jeff Legget
DM: Mike Doyle
Address: 4402 North Division
Spokane, WA 99204

TEMECULA

Phone: (909) 694-9877
Fax: (909) 676-1855
SM: Chris Roberson
BM: Gudron Feola
Address: 27230 Madison Ave
Ste A & B
Temecula, CA 92390

TORRANCE

Phone: (310) 768-8402
Fax: (310) 768-0003
SM: Tim Burchett
BM: Carmella Garcia
Address: 1625 W 190th St
Gardena, CA 90248

VISTA

Phone: (760) 630-7676
Fax: (760) 630-7772
SM: Mark Arndt
Address: 1954 Hacienda Dr
Vista, CA 92083

SAN MARCOS WHS

Phone: (760) 736-7655
Fax: (760) 736-7661
Address: 1070 Commerce St
San Marcos, CA 92069

WESTMINSTER

Phone: (714) 895-6320
Fax: (714) 895-5030
SM: Marc McAllister
BM: Jay Chouler
Address: 14852 Beach Blvd
Westminster, CA 92683

*CAL SPAS, the world's largest spa manufacturer now offers a complete line of **HOME RESORT PRODUCTS.***

*From game room accessories and pool tables to complete backyard packages featuring spas, gazebos, barbecues and decorative patio furniture. These products and more are now available from the leader in home relaxation. Call us at **1-800-CAL-SPAS** for your nearest retailer.*

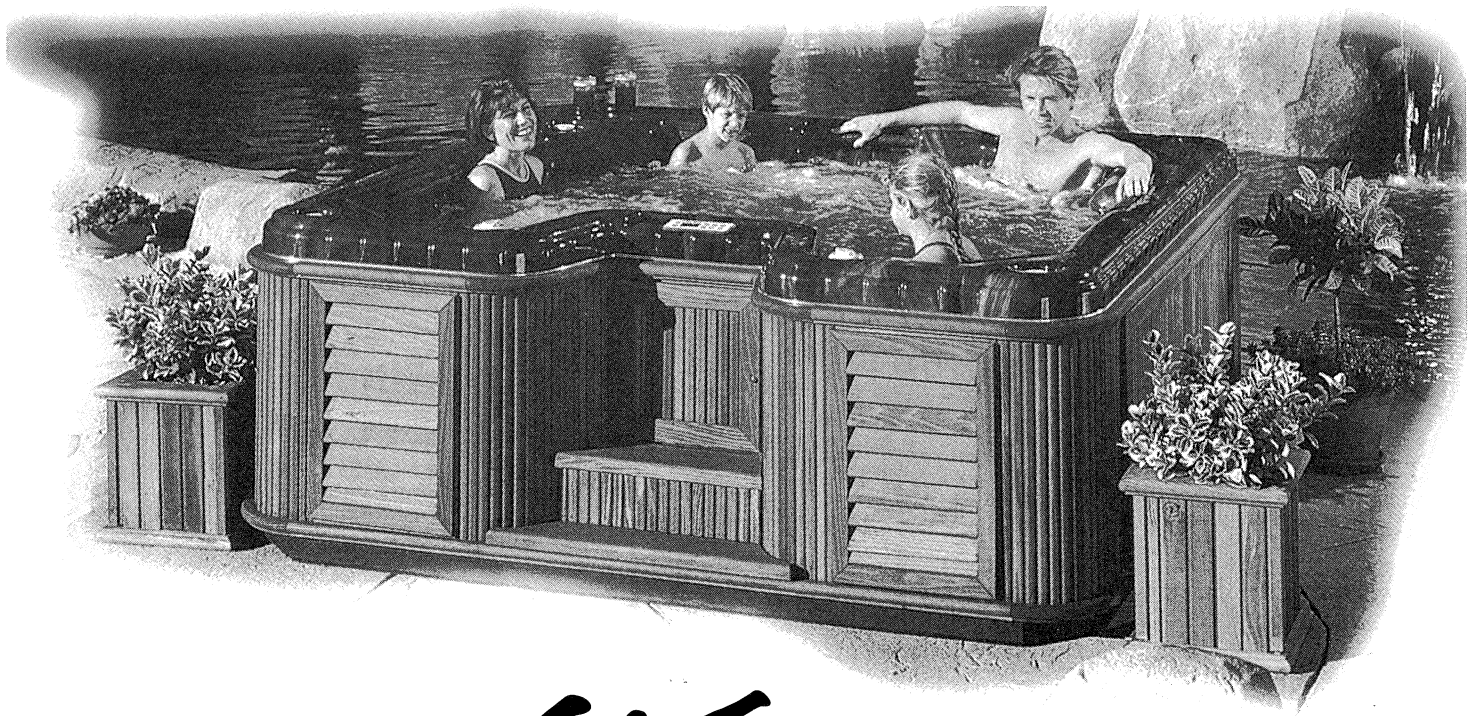

Cal Spas[®]
A Division of California Acrylic Industries, Inc.
CHANGING THE WAY YOU FEEL
Powered by GE Motors

Providing all your Home Resort needs.

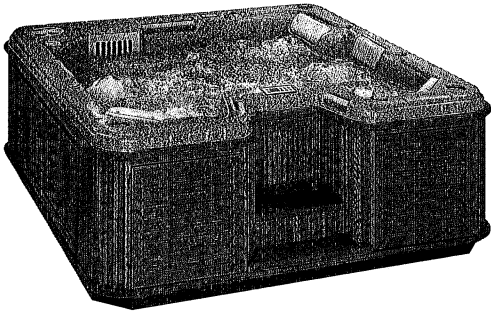

System Spa

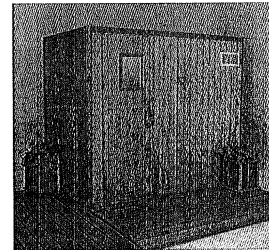

Saunas

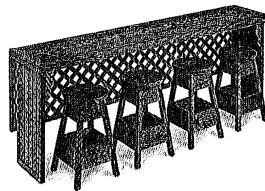

Bar Kits

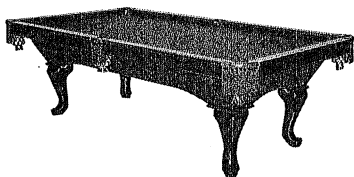

Billiards

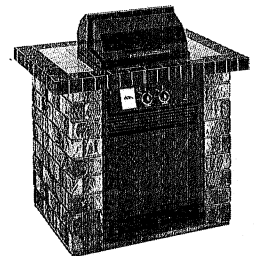

Barbecues

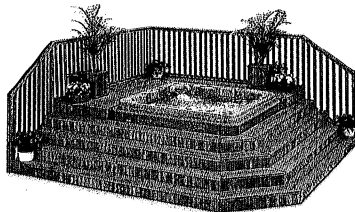

Deck Packages

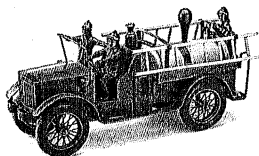

*Game Room
Accessories*

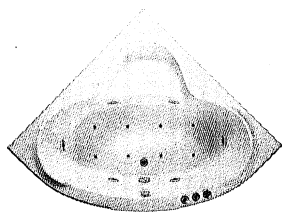

Bathtubs

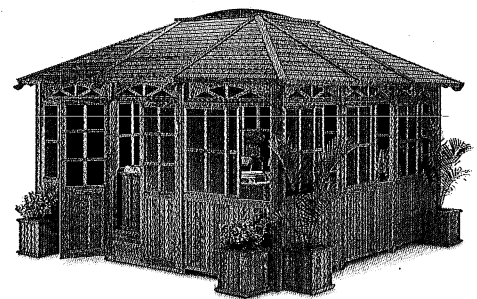

Gazebos

Cal Spas[®]
A Division of California Acrylic Industries, Inc.
CHANGING THE WAY YOU FEEL
Powered by GE Motors