

**LCD Series, 2005 ProTech™
Owner's Manual**

230 VAC, 3-Wire Connection

USE COPPER CONDUCTORS ONLY. WIRE SIZE MUST

Table of Contents

1.0	Important Spa Owner Information	1
2.0	FCC Notice	1
3.0	Important Safety Instructions	2
3.1	Important CSA Safety Instructions (Canada Only)	3
3.2	Hyperthermia	4
3.3	Cautions	4
3.4	General Electrical Safety Instructions	5
4.0	Choosing A Location	6
4.1	Outdoor Location	6
4.2	Indoor Location	6
5.0	Power Requirements	7
6.0	Electrical Wiring Instructions	9
7.0	Start-Up Instructions	11
7.1	Filling The Spa	11
7.2	Safety Check	11
7.3	Turn on Power	11
7.4	Initiating Water Circulation	11
7.5	Add Start-Up Chemicals	12
7.6	Place Cover on Spa	12
8.0	Control Functions	12
8.1	Control Panel	12
8.2	LCD Display	13
8.3	Spa Features And Controls	14
8.4	Jet/Air Controls Diagram (J-385 & J-375)	15
8.5	Jet/Air Controls Diagram (J-365 & J-355)	16
9.0	Operating Instructions	17
9.1	Set Spa to Heat	17
9.2	View	17
9.3	Light	17
9.4	Activate Pump 1	18
9.5	Activate Pump 2/Pump 3	18
9.6	Selecting Desired Massage Action	18
9.7	Adjusting Individual Jet Flow	19
9.8	Adjusting PowerPro Jets	19
9.9	Waterfall Feature	19

9.10	Air Controls	19
9.11	Optional Jacuzzi Premium Audio System.....	19
10.0	Automatic Filtration Cycles	27
10.1	Standard Skimming/Heating Mode	27
10.2	Economy Skimming/Heating Mode.....	27
10.3	Selecting Standard or Economy Skimming/Heating Mode	27
10.4	Preset Skimming/Heating Cycles	28
10.5	Clean-Up Cycle.....	28
11.0	Programming Instructions	29
11.1	Adjusting Time of Day.....	29
11.2	Changing Skimming/Heating Cycles	29
11.3	Programming The Filter Change Reminder.....	30
11.4	Programming Circulation Pump Run Time	30
11.5	Locking Skimming/Heating Cycles	31
11.6	Panel Lock	31
11.7	Temperature Setting Lock.....	32
12.0	Spa Maintenance	32
12.1	Cleaning The Filters.....	32
12.2	Draining and Refilling.....	34
12.3	Cleaning The Spa Interior.....	35
12.4	Pillow Care.....	35
12.5	Maintaining The Cover.....	36
12.6	Maintaining The Cabinet.....	36
12.7	Winterizing	36
12.8	Restarting Your Spa in Cold Weather.....	37
13.0	Water Quality Maintenance	38
13.1	pH Control.....	38
13.2	Sanitizing	38
13.3	Optional CD Ozone Water Maintenance System	39
13.4	Summer Logic.....	39
14.0	Troubleshooting - Display Messages	40
15.0	Troubleshooting - Procedures.....	42
16.0	Wiring Diagram (60Hz J-355/J-365/J-375 Models)	44
17.0	Wiring Diagram (60Hz J-385 Model).....	45
18.0	Wiring Diagram (50Hz J-355/J-365/J-375 Models)	46
19.0	Wiring Diagram (50Hz J-385 Model).....	47
20.0	Typical Spa Wiring Diagrams A-B (60Hz Models).....	48



1.0 Important Spa Owner Information

Your Jacuzzi® spa is constructed to the highest standards and is capable of providing many years of trouble-free use. However, because heat retentive materials are utilized to insulate the spa for efficient operation, an uncovered spa surface directly exposed to sunlight and high temperatures for an extended period is subject to permanent damage. Damage caused by exposing the spa to this abuse is not covered by warranty. We recommend that you always keep the spa full of water when it is exposed to direct sunlight and that you keep the Jacuzzi insulating cover in place at all times when the spa is not in use. Read and carefully follow the requirements for your spa's support base found in section 4.0 titled, "Choosing a Location".

Jacuzzi constantly strives to offer the finest spas available, therefore modifications and enhancements may be made which affect the specifications, illustrations and/or instructions contained herein.

2.0 FCC Notice

This equipment has been tested and found to comply with the limits for a Class B Digital Device, pursuant to Part 15 of the FCC Rules.  These limits are designed to provide reasonable protection against harmful interference in a residential installation. This equipment generates, uses and can radiate radio frequency energy and, if not installed and used in accordance with the instructions, may cause harmful interference to radio communications. However, there is no guarantee that interference will not occur in a particular installation. If this equipment does cause harmful interference to radio or television reception, which can be determined by turning the equipment off and on, the user is encouraged to try to correct the interference by one or more of the following measures:

1. Rearrange or relocate the receiving antenna.
2. Increase the separation between the equipment and receiver
3. Connect the equipment into an outlet on a circuit different from the circuit connected.
4. Consult the dealer or an experienced radio/TV technician for help.

Changes or modifications not expressly approved by the party responsible for FCC compliance could void the user's authority to operate this equipment.



3.0 IMPORTANT SAFETY INSTRUCTIONS



When installing and using this electrical equipment, basic safety precautions should always be followed, including:

1. READ AND FOLLOW ALL INSTRUCTIONS BEFORE OPERATING THE SPA!
2. WARNING: To reduce the risk of injury, do not permit children to use this product unless they are closely supervised at all times.
3. WARNING: A grounding wire connector is provided on this unit to connect a minimum No. 8 AWG (8.4mm²) solid copper conductor between this unit and any metal equipment, metal enclosures of electrical equipment, metal water pipe, or conduit within 5 feet (1.5m) of the unit.
4. DANGER: *Risk of Accidental Drowning*. Extreme caution must be exercised to prevent unauthorized access by children. To avoid accidents, ensure that children cannot use this spa unless they are supervised at all times.
5. DANGER: *Risk of Injury*. The suction fittings in this spa are sized to match the specific water flow created by the pump. Should the need arise to replace the suction fittings or the pump, be sure that the flow rates are compatible. Never operate the spa if the suction fittings are broken or missing. Never replace a suction fitting with one rated less than the flow rate marked on the original suction fitting.
6. DANGER: *Risk of Electric Shock*. Install at least 5 feet (1.5m) from all metal surfaces. As an alternative, a spa may be installed within 5 feet of metal surfaces if each metal surface is permanently connected (bonded) by a minimum No. 8 AWG (8.4mm²) solid copper conductor attached to the wire connector on the grounding lug, inside the equipment compartment on the equipment box.
7. DANGER: *Risk of Electric Shock*. Do not permit any electrical appliance, such as a light, telephone, radio, television, etc. within 5 feet (1.5m) of a spa, unless such appliances are built-in by the manufacturer.
8. ELECTRICAL SUPPLY: The electrical supply for this product must include a suitably rated switch or circuit breaker to open all ungrounded supply conductors to comply with section 422-20 of the National Electrical Code, ANSI/NFPA 70. The disconnect must be readily accessible and visible to the spa occupant but installed at least 5 feet (1.5m) from the spa water.
9. WARNING: To Reduce the Risk of Injury:
 - A. The water in a spa should never exceed 104 °F (40 °C). Water temperatures between 100 °F (38 °C) and 104 °F (40°C) are considered safe for a healthy adult. Lower water temperatures are recommended for young children and when spa use exceeds 10 minutes.



- B. Since excessive water temperatures have a high potential for causing fetal damage during the early months of pregnancy, pregnant or possibly pregnant women should limit spa water temperatures to 100 °F (38 °C). If pregnant, please consult your physician before using a spa.
- C. Before entering the spa, the user should measure the water temperature with an accurate thermometer since the tolerance of water temperature-regulating devices may vary as much as ± 5 °F (± 2 °C).
- D. The use of alcohol, drugs, or medication before or during spa use may lead to unconsciousness with the possibility of drowning. Persons using medication should consult a physician before using a spa since some medication may induce drowsiness, while other medication may affect heart rate, blood pressure, and circulation.
- E. Persons suffering from obesity or a medical history of heart disease, low or high blood pressure, circulatory system problems, or diabetes should consult a physician before using a spa.

3.1 IMPORTANT CSA SAFETY INSTRUCTIONS (CANADA ONLY)



When using this electrical equipment, basic safety precautions should always be followed, including the following:

1. READ AND FOLLOW ALL INSTRUCTIONS.
2. A green colored terminal or a terminal marked G, Gr, Ground, Grounding or the \oplus symbol* is located inside the supply terminal box or compartment. To reduce the risk of electric shock, this terminal must be connected to the grounding means provided in the electric supply service panel with a continuous copper wire equivalent in size to the circuit conductors that supply this equipment (*IEC Publication 417, Symbol 5019).
3. At least two lugs marked "Bonding Lugs" are provided on the external surface or on the inside of the supply terminal box/compartment. To reduce the risk of electric shock, connect the local common bonding grid in the area of the spa to these terminals with an insulated or bare copper conductor not smaller than No. 6 AWG (10mm²).
4. All field-installed metal components such as rails, ladders, drains or other similar hardware within 10 feet (3m) of the spa shall be bonded to the equipment grounding buss with copper conductors not smaller than No. 6 AWG (10mm²).
5. Save These Instructions:
 - A. WARNING: Children should not use spas without adult supervision.
 - B. WARNING: Do not use spas unless all suction guards are installed to prevent body and hair entrapment.



- C. WARNING: People with infectious diseases should not use a spa.
- D. WARNING: To avoid injury, exercise care when entering or exiting the spa.
- E. WARNING: Do not use drugs or alcohol before or during the use of a spa to avoid unconsciousness and possible drowning.
- F. WARNING: Pregnant or possibly pregnant women should consult a physician before using a spa.
- G. WARNING: Water temperature in excess of 38 °C (104 °F) may be injurious to your health.
- H. WARNING: Before entering the spa, measure the water temperature with an accurate thermometer.
- I. WARNING: Do not use a spa immediately following strenuous exercise.
- J. WARNING: Prolonged immersion in a spa may be injurious to your health.
- K. WARNING: Do not permit electric appliances (such as light, telephone, radio, television, etc.) within 5 feet (1.5m) of this spa unless factory installed.
- L. CAUTION: Maintain water chemistry in accordance with manufacturer's instructions.
- M. WARNING: The use of alcohol or drugs can greatly increase the risk of fatal hyperthermia in spas.

3.2 HYPERTHERMIA

Prolonged immersion in hot water may induce hyperthermia. A description of the causes, symptoms, and effects of hyperthermia are as follows:

Hyperthermia occurs when the internal temperature of the body reaches a level several degrees above the normal body temperature of 98.6 °F (37 °C). The symptoms of hyperthermia include drowsiness, lethargy, and an increase in the internal temperature of the body. The effects of hyperthermia include:

- A. Unawareness of impending hazard;
- B. Failure to perceive heat;
- C. Failure to recognize the need to exit spa;
- D. Physical inability to exit spa;
- E. Fetal damage in pregnant women; and
- F. Unconsciousness and danger of drowning.

3.3 CAUTIONS

1. Persons suffering from heart disease, diabetes, high or low blood pressure, and any condition requiring medical treatment, pregnant women, the elderly, or infants should consult with a physician before using a spa.



2. The Consumer Products Safety Commission has stated that the water temperature in a spa should not exceed 104 °F (40 °C). Immersion in water in excess of 104 °F (40 °C) can be hazardous to your health.
3. Observe a reasonable time limit when using the spa. Long exposures at higher temperatures can cause high body temperature. Symptoms may include dizziness, nausea, fainting, drowsiness, and reduced awareness. These effects could possibly result in drowning.
4. Do not use the spa under the influence of alcohol, narcotics, or other drugs. Use of the spa under these conditions may lead to serious consequences.
5. Always test the spa water temperature before entering the spa. Enter and exit the spa slowly. Wet surfaces can be very slippery.
6. Never bring any electrical appliances into or near the spa. Never operate any electrical appliances from inside the spa or when you are wet unless such appliances are built-in by the manufacturer.
7. Proper chemical maintenance of spa water is necessary to maintain safe water and prevent possible damage to spa components.
8. Use the straps and clip tie downs to secure the cover when not in use. This will help to discourage unsupervised children from entering the spa and keep the spa cover secure in high-wind conditions. There is no representation that the cover, clip tie-downs, or actual locks will prevent access to the spa.

3.4 GENERAL ELECTRICAL SAFETY INSTRUCTIONS

Your new Jacuzzi spa is equipped with a “state-of-the-art” equipment system. It contains the most advanced safety and self-protective equipment in the industry. Nonetheless, this spa must be installed properly to insure dependable usage. Please contact your dealer or local building department should you have any questions regarding your installation.

Proper grounding is extremely important. Jacuzzi spas are equipped with a current collector system. A pressure wire connector is provided on the surface of the control box, located outside the equipment door (Figure B, Page 10) to permit connection of a bonding wire between this point and any ground metal equipment, metal water pipe or conduit within 5 feet (1.5m) of the spa, or copper clad grounding rod buried within 5 feet (1.5m) of the spa. Bonding wire must be at least No. 8 AWG (8.4mm²) solid copper wire. This is a most important safety assurance feature. Before installing this spa, check with the local building department to insure installation conforms to local building codes.



4.0 Choosing A Location



IMPORTANT: Because of the combined weight of the spa, water and users, it is extremely important that the base upon which the spa rests be smooth, flat, level and capable of uniformly supporting this weight, without shifting or settling, for the entire time the spa is in place. If the spa is placed on a surface which does not meet these requirements, damage to the skirt and/or the spa shell may result. Damage caused by improper support is not covered under warranty. It is the responsibility of the spa owner to assure the integrity of the support at all times.

We recommend a poured, reinforced concrete slab with a minimum thickness of 4 inches (10cm). Wood decking is also acceptable provided it is constructed so that it meets the requirements outlined above. The spa must be installed in such a manner as to provide drainage away from the spa. Placing the spa in a depression without provisions for proper drainage could allow rain, overflow and other casual water to flood the equipment and create a wet condition in which it would sit. For spas which will be recessed into a floor or deck, install so as to permit access to the equipment, either from above or below, for servicing. Make certain that there are no obstructions which would prevent removal of the cabinet side panels and access to the jets components, especially on the side with the equipment bay doors.

4.1 Outdoor Location

In selecting the ideal outdoor location for your spa, we suggest that you take into consideration:

1. The proximity to changing area and shelter (especially in colder weather).
2. The pathway to and from your spa (this should be free of debris so that dirt and leaves are not easily tracked into the spa).
3. The closeness to trees and shrubbery (remember that leaves and birds could create extra work in keeping the spa clean).
4. A sheltered environment (less wind and weather exposure can result in lowered operation and maintenance costs).
5. The overall enhancement of your environment. It is preferable not to place the spa under an unguttered roof overhang since run-off water will shorten the life expectancy of the spa cover.

4.2 Indoor Location

For indoor installations, be certain to make provisions for proper ventilation. When the spa is in use, considerable amounts of moisture will escape. This can damage certain surfaces over time. If you have any questions regarding the placement or installation of your spa, consult your authorized Jacuzzi dealer.



5.0 Power Requirements

Jacuzzi spas are designed to provide optimum performance and flexibility of use when connected to the maximum electrical service as listed in the tables below. If you prefer, your Jacuzzi dealer can perform a minor circuit board modification to allow the spa to accept different electrical service. The operational considerations of these modifications are listed in the footnotes below.

US/Canada J-355/J-365/J-375 Models (60Hz)

	<u>240V/50A*</u>	<u>240V/60A**</u>	<u>240V/35A***</u>
Voltage:	240 VAC	240 VAC	240 VAC
Number of Wires:	3	3	3
Frequency:	60Hz	60Hz	60Hz
Current Draw:	36A	43A	26A
Circuit Breaker:	50A, 2-Pole	60A, 2-Pole	35A, 2-Pole

Important Information:

- * In 50A configuration, the heater **will not operate** while both jets are running in high speed. ***This is the factory setting.*** Note: *pump 2 runs only in high speed.*
- ** In 60A configuration, the heater **will operate** while both jets pumps are running in high speed. Note *jets pump 2 runs only in high speed.*
- *** In 35A configuration, the heater **will not operate** while either jets pump is running in high speed. Note: *jets pump 2 runs only in high speed.*

NOTE: When a 35A is not available, use a 40A

US/Canada J-385 Models (60Hz)

	<u>240V/60A*</u>	<u>240V/50A**</u>	<u>240V/40A***</u>
Voltage:	240 VAC	240 VAC	240 VAC
Number of Wires:	3	3	3
Frequency:	60Hz	60Hz	60Hz
Current Draw:	46A	36A	31A
Circuit Breaker:	60A, 2-Pole	50A, 2-Pole	40A, 2-Pole

Important Information:

- * In 60A configuration, the heater **will operate** while any two jets pumps are running in high speed. ***This is the factory setting.***
- ** In 50A configuration, the heater **will not operate** while any two jets pumps are running in high speed. Note: *jet pumps 2&3 run only in high speed.*
- *** In 40A configuration, the heater **will not operate** while any jets pump is running in high speed. Note: *jet pumps 2&3 runs only in high speed.*



Export J-355/J-365/J-375 Models (50Hz)

	<u>230V/20A*</u>	<u>230V/30A**</u>	<u>230V/40A***</u>
Voltage:	230 VAC	230 VAC	230 VAC
Number of Wires	3	3	3
Frequency:	50Hz	50Hz	50Hz
Current Draw:	15A	23A	29A
Circuit Breaker:	20A	30A	40A

Important Information:

- * In 20A configuration, the heater **will not operate** while either jets pump is running in high speed. *Note: jets pump 2 runs only in high speed. **This is the factory setting.***
- ** In 30A configuration, the heater **will not operate** when both jets pumps are running in high speed. *Note jets pump 2 runs only in high speed.*
- *** In 40A configuration, the heater **will operate** while both jets pumps are running in high speed.

All export models can be adapted to use higher amperage circuits when available. Please contact your dealer for details. The electrical supply for this product must comply with local electrical regulations.

Export J-385 Models (50Hz)

	<u>230V/35A*</u>	<u>230V/40A**</u>
Voltage:	230 VAC	230 VAC
Number of Wires	3	3
Frequency:	50Hz	50Hz
Current Draw:	26A	32A
Circuit Breaker:	35A, 2-pole	40A, 2-pole

Important Information:

- * In this configuration, the heater **will not operate** while any two jets pumps are running in high speed. *Note: Pump #2 and Pump #3 only run in high speed.*
- ** In this configuration, the heater **will not operate** while all three jets pumps are running in high speed. *Note: Pump #2 and Pump #3 only run in high speed.*

All export models can be adapted to use higher amperage circuits when available. Please contact your dealer for details. The electrical supply for this product must comply with local electrical regulations.



6.0 Electrical Wiring Instructions



IMPORTANT NOTICE: The electrical wiring of this spa must meet the requirements of the National Electrical Code (NEC) and any applicable state or local codes. The electrical circuit must be installed by a qualified electrician and approved by a local building/electrical inspection authority.

1. This spa must be permanently connected (hard-wired) to the power supply. **No plug-in connections or extension cords are to be used in conjunction with the operation of this spa.** Supplying power to the spa which is not in accordance with these instructions will void both the independent testing agency listing and the manufacturer's warranty.
2. The power supplied to this spa *must* be a *dedicated* circuit with no other appliances or lights sharing the power provided by the circuit.
3. To determine the current and voltage and wire size required, refer to section 5.0 "Power Requirements" (Page 7-8).
 - Wire size must be appropriate per NEC and/or local codes.
 - We recommend type THHN wire.
 - All wiring must be copper to ensure proper connections. **Do not use aluminum wire.**
 - When using wire larger than #6 (10mm²), add a junction box near the spa and reduce to short lengths of #6 (10mm²) wire to connect to spa.
4. The electrical supply for this product must include a suitably rated switch or circuit breaker to open all ungrounded supply conductors to comply with Section 422-20 of the National Electrical Code, ANSI/NFPA 70. The disconnecting means must be readily accessible to the spa's occupant but installed at least 5 feet (1.5m) from spa water.
5. The electrical circuit supplied for the spa must include a suitable ground fault circuit interruptor (GFCI) as required by NEC Article 680-42.
6. To gain access to the spa's power terminal block, remove the screws curving the panel under the controls. Then remove the four control box door screws and door (Figure B, Page 10).
7. Select the power supply inlet you want to use (Figure A, Page 10) and remove the short cabinet panel from the front of the spa to allow you to feed the cable through to the control box. Install the cable with connector through the large opening provided in the bottom of the control box.
8. Connect wires, color to color, on terminal blocks TB1 and TB3 (Figures C-D, Page 10). **TIGHTEN SECURELY!** All wires must be hooked up securely or damage could result.
9. Install control box door and screws and reinstall the cabinet side panels.

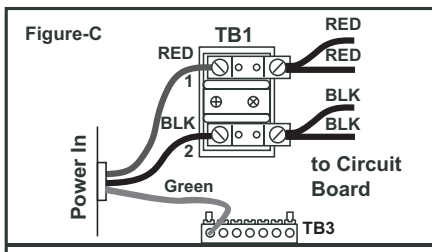
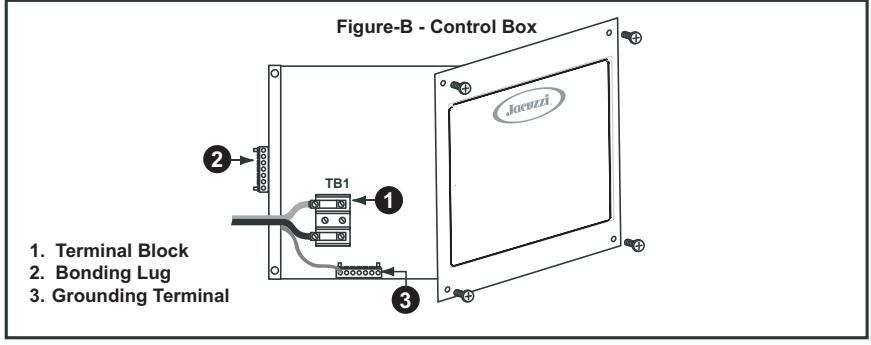
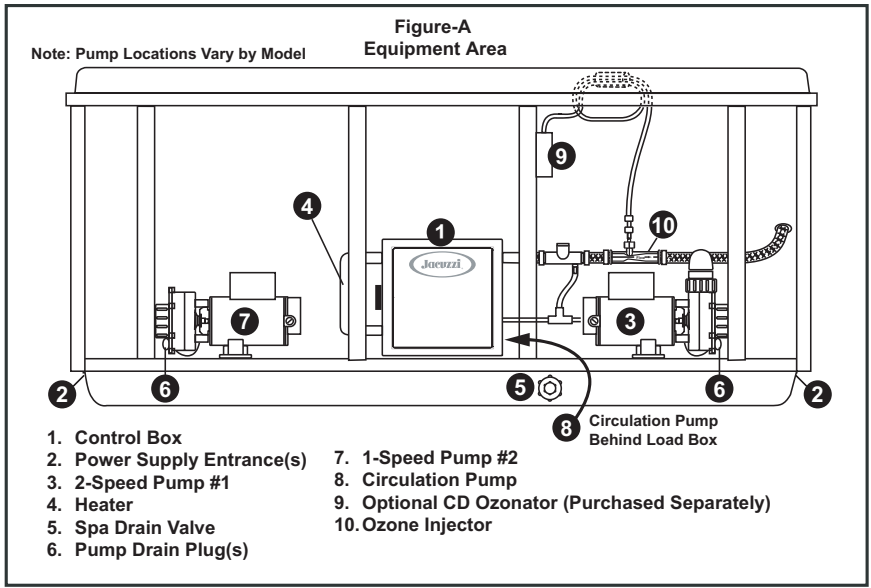

US/Canada J-355 / J-365 / J-375 / J-385
Models: 240 VAC, 3-Wire Connection (60Hz)

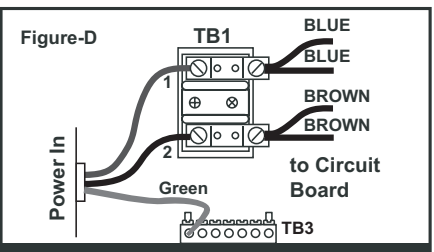

All Export J-355 / J-365 / J-375 / J-385
Models: 230 VAC, 3-Wire (50Hz)



7.0 Start-Up Instructions

Congratulations! You are now all set to get your new spa ready to use. Simply follow this step-by-step procedure and, before long, you will be enjoying your first glorious experience in your Jacuzzi spa. For best results, read each step in its entirety before proceeding with that step.

7.1 Filling the Spa

Clear all debris from the spa. Although the spa shell has been polished at the factory, you may want to treat it with a specially formulated spa cleaner and wax available from your dealer prior to filling the first time.

Remove the filter cover, then remove and clean the strainer bag and both filter cartridges as outlined in section 12.1 (Page 32-34). Place the end of your garden hose into the exposed pump #1 filter wall fitting without a mesh grill. Fill the spa half way, then place end of your garden hose into the circulation pump filter wall fitting with the mesh grill. Continue filling spa until the water level is 1 inch below the lowest pillow and above all jets. **Do not over fill.** Never fill with water from a water softener.

If your water is extremely “hard”, it is preferable to fill half-way with hard water and the rest of the way with softened water. Or, you may fill entirely with hard water if you use a special water additive available from your Jacuzzi dealer. Always refill spa through both filter wall fittings to purge trapped air from pump intakes. Failure to do so may cause air to be trapped in either pump #1 or the circulation pump’s intake (air lock), preventing either pump from circulating water. After filling, make sure both filters are installed properly before applying power to the spa. Refer to section 12.1 (Page 32-34) “Cleaning the Filters” for specific cleaning and installation instructions.

7.2 Safety Check

Open the cabinet access panel and check all pump unions to make sure they are hand tight. Loosening can occur during shipping and handling.

7.3 Turn on Power

Turn on power to spa at the home’s circuit breaker. The heater and circulation pump will automatically activate. If the control panel LCD flashes water temperature and “COOL” or “ICE”, the pump 1 will also activate in low speed. If this occurs, refer to page 40-41 for additional information.

7.4 Initiating Water Circulation

Depress the **JETS 1** sensor pad on the control panel twice to activate pump #1 in high speed and initiate maximum water flow to certain jets.





7.5 Add Start-Up Chemicals

Add the spa water chemicals as recommended by your Jacuzzi Dealer. Refer to section 13.0 (Page 38) for general guidance.

7.6 Place Cover On Spa

Keeping the insulating cover in place anytime the spa is not in use will reduce the time required for heating, thereby minimizing operating costs. The time required for initial heat-up will vary depending on the starting water temperature and the capacity of your spa. Smaller spas heat at a rate of approximately 8 to 10 degrees per hour; larger spas heat at about 4 to 6 degrees per hour.



WARNING: RISK OF INJURY. Always check water temperature carefully before entering spa.

8.0 Control Functions

8.1 Control Panel

- A. Select Sensor Pad: filter cycle programming features.
- B. Cycle Sensor Pad: accesses filter cycle program mode and next cycle.
- C. Mode Sensor Pad: switches between standard and economy skimming/heating modes (Page 27).
- D. Display Sensor Pad: displays time of day and initiates time setting and locking functions.
- E. Invert Sensor Pad: inverts the main 4-digit LCD display.
- F. Warmer + / Cooler - Sensor Pads: these sensors display and increase or decrease the temperature setting. They also display other programmable features.
- G. Light Sensor Pad: controls the spa light (Page 17).
- H. JETS 1 Sensor Pad: controls the 2-speed pump #1 (Low, High, Off).
- I. JETS 2 Sensor Pad: controls jet pumps 2&3 as follows:
 - In J-355/J-365/J-375 Models: controls high-speed pump #2 (On, Off).
 - In J-385 Models: controls high-speed pump 2&3 (On, Off)

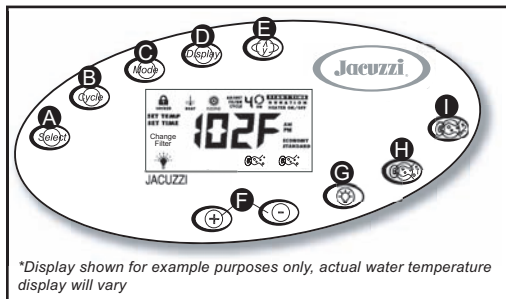



8.2 LCD Display

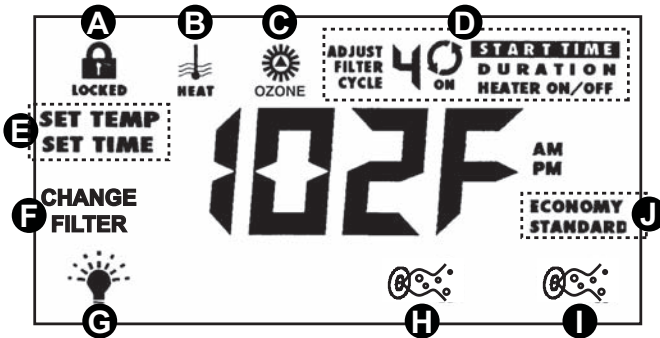

- A. Lock Symbol indicates panel, set temperature, or filter cycle programming is locked.
- B. Heat Symbol: indicates heater is on (Sec. 9.1, Page 17).
- C. Ozone Symbol indicates the optional CD Ozonator is on Sec. 13.3, Page 39).
- D. General Indicators: show which skimming/heating cycle is in progress or display selected skimming/heating cycle programming features (Sec. 11.2, Page 29).
- E. Set Indicators: these characters identify what is being shown on the main 4-digit display.
- F. Indicates programmed filter cleaning interval has elapsed (Sec. 11.3 Page 30).
- G. Light Symbol: indicates spa light is on.
- H. JETS 1 Symbol indicates 2-speed pump #1 is on. The symbol changes according to speed selected and flashes during an automatic operation.
- I. JETS 2 Symbol indicates the following:
 - On J-355, J-365, J-375 models, this symbol indicates high-speed pump #2 is on.
 - On J-385 models, this symbol indicates either high-speed pump #2 and/or pump #3 are on.
- J. Mode Annunciators: these characters identify which skimming/heating mode is currently selected (Page 27).



8.3 Spa Features And Controls



J-375 model illustrated - Location of Features Varies by Model

- | | |
|---|--|
| 1. Control Panel | 11. Vertical Jets (Foot Jets) |
| 2. Air Controls | 12. Footwell Suction Fittings and Filters. Filters protect pump 2 (and J-385 pump 3) plumbing network from debris buildup. |
| 3. Filter/Skimmer Bag Cover | 13. Waterfall Feature |
| 4. Diverter Valve #2 | 14. PowerPro FX Jets (Calf Jets) |
| 5. PowerPro MX Jets | 15. Micro PowerPro SX Jets (Wrist Jets) |
| 6. PowerPro LX Jets/Mini-PowerPro FX Jets | 16. Heater Return Fitting |
| 7. Diverter Valve #1 | 17. Optional Audio System Speakers |
| 8. Remote Control Panel | 18. Optional Audio System Receiver |
| 9. Therapy Seat | |
| 10. Spa Light | |



8.4 Jet/Air Controls Diagram (J-385 & J-375)

J-385

Massage Selector Operation

Rotate Massage Selectors 1 & 2 to Divert Water Between Jet Groups A-D.

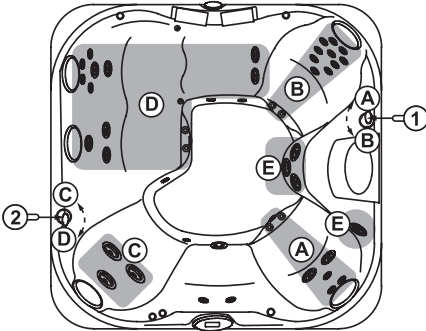

Massage Selector #1 Controls Pump 1
Massage Selector #2 Controls Pump 2
Foot and Side Wall Jets E Powered by Pump 3

J-375

Massage Selector Operation

Rotate Massage Selectors 1 & 2 to Divert Water Between Jet Groups A-E.

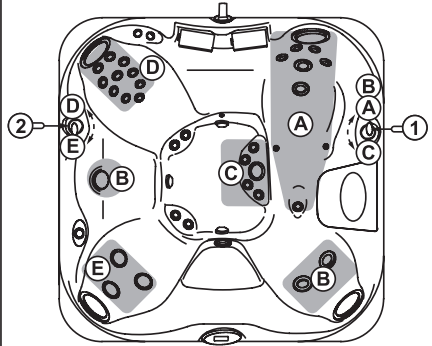

Massage Selector #1 Controls Pump 1
Massage Selector #2 Controls Pump 2

Air Control Operation

Depress Air Controls A-E to Open or Close Air Inlet to Designated Jet Groups.

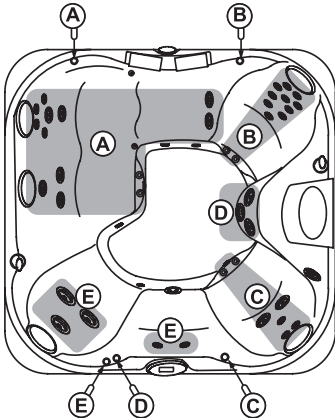

Air Control Operation

Depress Air Controls A-E to Open or Close Air Inlet to Designated Jet Groups.

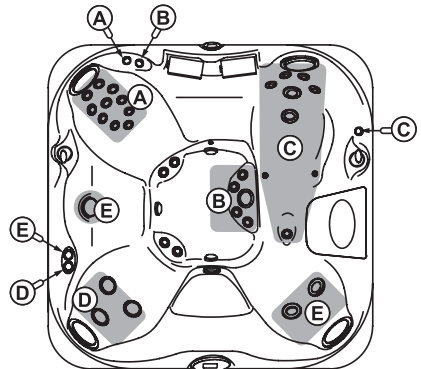



8.5 Jet/Air Controls Diagram (J-365 & J-355)

J-365

Massage Selector Operation

Rotate Massage Selectors 1 & 2 to Divert Water Between Jet Groups A-D.

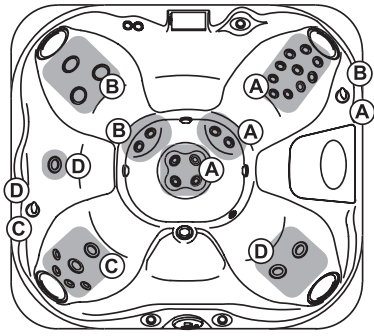

Massage Selector #1 Controls Pump 1
 Massage Selector #2 Controls Pump 2
 Foot and Side Wall Jets E Powered by Pump 3

Air Control Operation

Depress Air Controls A-D to Open or Close Air Inlet to Designated Jet Groups.

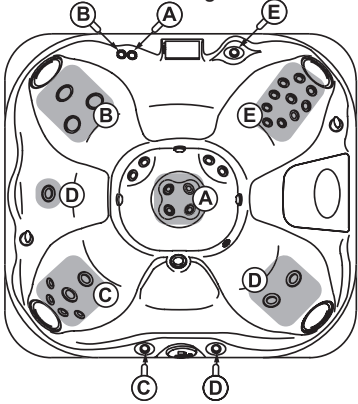

J-355

Massage Selector Operation

Rotate Massage Selectors 1 & 2 to Divert Water Between Jet Groups A-D.

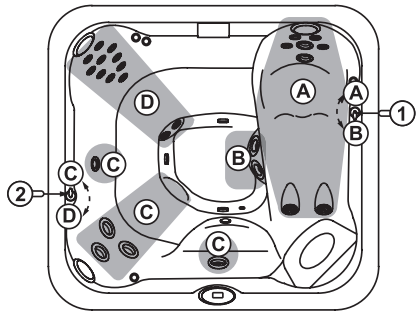

Massage Selector #1 Controls Pump 1
 Massage Selector #2 Controls Pump 2

Air Control Operation

Depress Air Controls A-D to Open or Close Air Inlet to Designated Jet Groups.

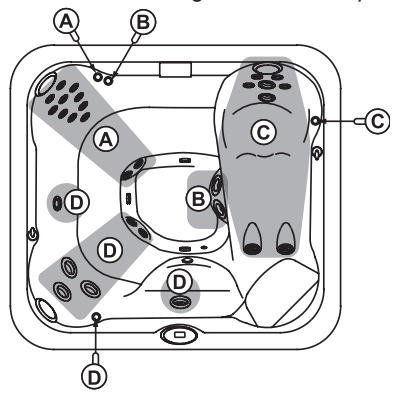



9.0 Operating Instructions

Your Jacuzzi spa has a touch-sensitive control panel, diverter valves, and air control knobs located on the top rim of the spa (Page 14). These controls let you operate many of the special functions of your Jacuzzi spa. By familiarizing yourself with the following information, you will be able to gain the full benefit afforded by the various functions of your spa.

9.1 Set Spa To Heat

To warm spa water, follow these steps:

1. The LCD display on the control panel displays the actual temperature of the spa water. Press either the **WARMER (+)** or **COOLER (-)** sensor pad once to display the “set temperature” for 5 seconds. If you want the water to heat to a different temperature, simply press **WARMER (+)** or **COOLER (-)** within 5 seconds. The set temperature advances or decreases by one degree each time one of these sensor pads is pressed.
2. The heater will turn off when the temperature corresponding to the thermostat setting is achieved.

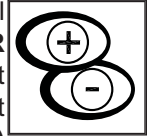

Important Heater Details:

- The maximum temperature for which the spa can be set is 104 °F (40 °C) and the minimum is 80 °F (27 °C).
- If spa is powered by the minimum required amp service (Page 7-8) turn off all high speed pumps to operate heater. *Note: jets Pump 2 and J-385 Pump 3 run only in high speed.*
- Setting the thermostat at maximum will not accelerate the heating process. This will only result in a higher ultimate temperature.
- The heater operates until the water reaches the programmed “set temperature”, then turns off. The heater will reactivate after the water cools to approximately 1.5° below the “set temperature.”

9.2 View

Pressing this sensor pad inverts the main four-digit display on the command center’s LCD screen to allow easy reading from either inside or outside the spa.



9.3 Light

The spa light offers 6 constant color variations and a unique random mode for enhanced spa enjoyment. Press the **LIGHT** sensor pad once to turn the spa light on in “Random” mode,





then repeatedly press the sensor pad to turn the light off or to select one of 6 constant colors illustrated below.

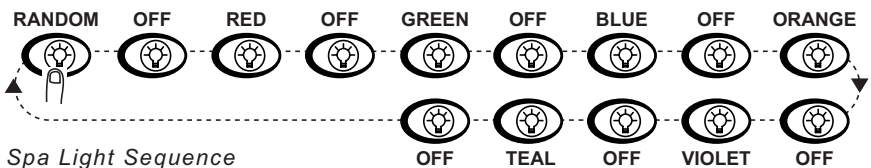

Spa Light Sequence

You must press the **LIGHT** sensor pad within 5 seconds between each “off” or “color” step in the light sequence to prevent it from resetting. Pressing the sensor pad after 5 seconds restarts the sequence at “Random” mode. This mode automatically changes the light color every 8 to 20 seconds. *Note: Any time the spa light is manually turned on, it will automatically turn off after approximately 1 hour. If you desire more light at this time, simply turn the light back on.*

9.4 Activate Pump 1

The sensor pad labeled **JETS 1** controls the 2-speed pump #1. Pressing this sensor cycles pump #1 from off, to low speed, to high speed, and back to off.



9.5 Activate Pump 2/Pump 3

On two pump J-355, J-365, J-375 models, the sensor pad labeled **JETS 2** controls the high-speed pump #2. Pressing this sensor cycles pump #2 on and off.



On the three pump J-385 model, this sensor pad controls both pump #2 and pump #3 in the following sequence:

- A) Press once to turn on pump #2 in high-speed;
- B) Press a second time to turn on pump #3 in high-speed;
- C) Press a third time to turn off pump 2;
- D) Press a fourth time to turn off pump #3.

Auto Turn Off — Anytime a pump has been manually turned on, it will automatically turn off after approximately 20 minutes. If at this time you desire more jet operation you may simply turn the pump(s) back on.

9.6 Selecting Desired Massage Action

Your Jacuzzi spa is equipped to allow you to customize the massage action you desire. Each model incorporates a massage selector that allow you to



customize the massage and performance by diverting water between various jet systems. Simply turn massage selector to position A (Combo), B, or C to divert water pressure to various jet groups. *Note: The massage selector valve(s) is designed to operate in positions A (Combo), B, and C for optimum performance. It is considered normal for sound levels within the valve to vary between positions due to the large amounts of water flowing through it! For optimum filtration benefits, leave the valve in position A when spa is covered. Select position B or C for maximum jet performance during spa use.*

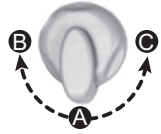

9.7 Adjusting Individual Jet Flow

The water flow to the individual jets in your spa can be increased or decreased by rotating the outside jet face. *Note: Always keep at least 6 adjustable jets open at all times.*



9.8 Adjusting PowerPro Jets

With the nozzles of the PowerPro Jets positioned straight ahead, the jet stream will be stationary. Pushing the nozzle to one side causes the jet nozzle to rotate, moving the jet stream in a circular pattern. *The jets may not spin with Jets 1 on low speed.*



9.9 Waterfall Feature

The waterfall feature allows you to independently control it for a customized soothing effect. The **JETS 1** button activates the waterfall feature. Then, each fall is individually adjusted moving the control lever next to it forward or backwards. To turn on, move lever inward. To turn off, move lever outward.

9.10 Air Controls

Certain jet systems have their own “push-button” air control. Each control introduces air into the water lines that supply that specific jet group. Simply press any air control button (once) to open; then press a second time to close. To minimize heat loss, all air controls should be closed when the spa is not in use.



9.11 Optional Jacuzzi Audio System

Spas equipped with the optional Jacuzzi Stereo System offer enhanced spa enjoyment. These models include an integrated AM/FM/CD receiver with two high-quality marine speakers for unsurpassed sound quality and long-life. Both speakers located on spa





corners (Sec. 8.3, page 14) are designed for manual extension and retraction. To expose each speaker for audio, simply press it's release button to unlatch the "pop-up" mechanism. To retract each speaker before covering spa, gently press downward on each speaker enclosure until you feel a slight "click", then release.

CAUTION: Never step or sit on a speaker enclosure! This type of misuse will damage the speaker enclosure latching and track mechanism. Always retract speakers prior to covering spa.

Optional Stereo Receiver - Features

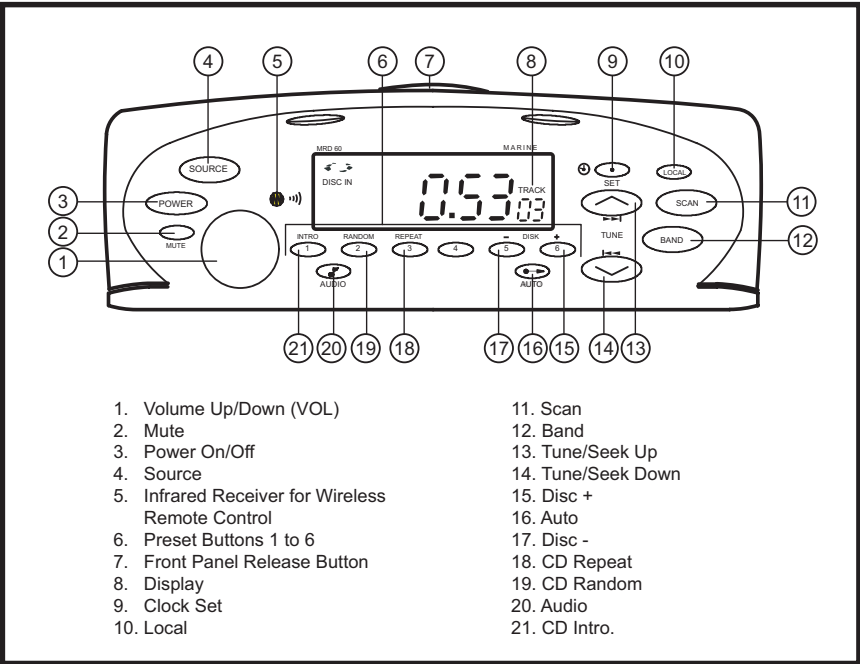

Optional Stereo Receiver General Controls

A. Power On and Off

Make sure spa power is turned on, then press the power button (3) once to turn on. Press a second time to turn off.

B. Adjusting Volume

Rotate the volume knob (1) to increase or decrease volume. Current volume setting is briefly indicated on the display (0 to 31).



C. Mute

Press the mute button (2) once to mute the audio output (“Mute” flashes on the display). To restore audio output, press the mute button a second time, or rotate the volume knob.

D. Program Selection

Press the source button (4) to cycle through available program sources as follows: Tuner - CD - Tuner. If a source is unavailable (e.g. no CD inserted), that source will not appear on the display.

E. Adjusting Bass Level

Press the audio button (20) until the display reads “BAS.” Rotate the volume knob to the desired setting. A display of “C O” indicates center, -2 to -12 indicates bass cut, and +2 to +12 indicates bass boost. *Note: the unit returns to volume mode if the volume control is not rotated for 3 seconds.*

F. Adjusting Treble Level

Press the audio button (20) until the display reads “TRE.” Rotate the volume knob to the desired setting. A display of “C O” indicates center, -2 to -12 indicates bass cut, and +2 to +12 indicates bass boost. *Note: the unit returns to volume mode if the volume control is not rotated for 3 seconds.*

G. Adjusting Balance

Press the audio button (20) until the display reads “BAL.” Rotate the volume knob to the desired setting. A display of “C O” indicates center, L1 to 15 indicates left balance, and R1 to 15 indicates right balance. *Note: the unit returns to volume mode if the volume control is not rotated for 3 seconds.*

Optional Stereo Receiver Radio Operation

A. Adjust Fader

Press the audio button (20) until the display reads “FAD.” Rotate the volume knob to the desired setting. A Display of “C O” indicates center, R1 to 15 indicates rear fade, and F1 to 15 indicates front fade. *Note: the unit returns to volume mode if the volume control is not rotated for 3 seconds.*

B. Display Clock

Press the set button (9) to toggle the display between the clock and radio modes. When the clock mode is selected, the current time displays whenever the unit is left undisturbed.



C. Set Clock

Press the set button (9) for 2 seconds until the first time digit flashes on the display. Use the tune/seek up button (13) or the tune/seek down button (14) to set the hour, noting the AM/PM indicator at the left. Briefly press the set button a second time to select the minutes display. Press the set button a third time to complete the procedure. The unit remains in clock mode and displays the time after 3 seconds. *Note: When power to the spa is shut off for any reason, the clock will be reset to 12:00AM.*

D. Open/Close Front Panel

Place your thumb on the front panel release button (7) with your forefinger below the front overhang. Press firmly on the release button, then flip the panel open by pulling outward at the top edge. To close the panel, flip the panel up and press firmly until you hear an audible click. Keep the front panel closed at all times to prevent water intrusion, except when changing discs. **CAUTION: never insert wet discs into the unit or the CD player will be damaged!**

E. Radio Operation

Press the source button (4) to select the radio mode. The station frequency is indicated on the display.

- To Select Band: press the band button (12) to toggle through the radio modes as follows: FM1 - FM2 - FM3 - AM1 - AM2 - FM1. Each radio band stores up to 6 independent presets, for a total of 18 FM and 12 AM presets.
- To Program Presets: tune in to the desired radio station, then press and hold the desired preset button for at least 2 seconds. "PX", where X = the preset number, appears at the bottom right of the display. *Note: When power to the spa is shut off for any reason, all station presets are reset.*

F. Automatically Setting Station Presets

To automatically set station presets to their next higher stations, press the oreset button (1 to 6) from which to start programming, then press and hold the auto button (16) for at least 2 seconds. The current preset and the additional preset memories up to P6 will be reprogrammed with their next higher stations. When the auto preset cycle is complete, the unit will remain in preset scan mode and continue scanning for presets until the auto button (16) is pressed. To select only the strongest stations, press the local button (10). All 18 FM and 12 AM presets can be set sequentially by selecting the next band and continuing the operation during auto programming.



G. Seek / Manual Tune

Press the tune/seek up button (13) once to automatically tune to the next higher station. Press the tune/seek down button (14) once to automatically tune to the next lower station. To manually tune to a specific station frequency, press and hold either tune/seek button for at least 2 seconds. Holding either button down will increase or decrease the displayed frequency manually. When the desired frequency is reached, release the button. The unit remains in manual tune mode for 3 seconds after either button is released so you can fine tune the station frequency with additional button presses. *Note: After 3 seconds, the seek mode is re-enabled.*

H. Scan Functions

Select any AM or FM band and press the scan button (11) to listen to a few seconds of each radio station. The display will flash and the radio will automatically scan to the next higher station. To stop scanning and continue listening to the current station, press the scan button a second time. *Note: the radio remains in scan mode until the scan button is pressed a second time or one of the tune buttons is pressed.*

I. Preset Scan Function

Press the auto button (16) once to enter scan mode. The next higher preset station will be selected and be played for 3 seconds while the preset number on the display flashes. If you wish to remain on this station, press the auto button (16) a second time. *Note: preset scanning continues unless you press the auto button (16) or either preset button (P1-P6) to cancel.*

J. Local/Distance Function

Press the local button (10) to toggle between local and distant station mode. When "LOCAL" is displayed, only the strongest stations will be selected during seek or scan. *Note: in the default mode (no LOCAL display), all usable stations will be selected during seek or scan.*

K. Changing Tuner Frequency From US To Europe

Your unit is factory set to US tuning frequency steps. To switch to Europe tuning steps, use the switch on the bottom of the unit. With the unit disconnected from the power source, use a screwdriver to *slide the switch to the desired position.* **Note: power must be removed from the radio, or the reset switch must be pressed before the new frequency mode is activated.**



Optional Stereo Receiver CD Player Operation

A. Insert, Play, And Eject A CD

Open the front panel and insert a CD into the slot with the CD label facing up. The CD will be drawn inside by the motorized mechanism. Close the front panel. The “DISC IN” symbol on the display indicates that a CD is in the drive.

- To play the CD: press the source button (4) to change to CD mode. The CD will play. The display shows the current track and play time, and will animate a 3-D rotating disc while the CD is playing. *Note: if the CD play time is not shown, press the clock button (9) once.*
- To remove the CD: open the front panel and press the CD eject button located under the front panel. Remove the CD from the drive and close the front panel. ***Note: listen for an audible click to ensure the front panel is closed to prevent water intrusion that could damage your unit.***

B. Changing CD Tracks And Music Seek

To advance to next track, press the tune/seek up button (13) once and the track counter will increase one track. When the final track is reached on the CD, play will resume on track #1.

- To fast forward through tracks: press and hold the tune/seek up button (13) until the track counter displays the desired track, then release the button.
- To return to the beginning of the current track: press the tune/seek down button (14). Pressing it a second time within 1 second will skip back to the previous track.
- To rewind the current track: press and hold the tune/seek down button (14). The track will quickly rewind until you release the button.

C. Intro Scan, Random, Repeat

- Intro Scan Mode: press intro button (21) to enter intro scan mode. The left side of the display reads “SCN” and the first 10 seconds of each CD track will play continuously until you press the intro button a second time, or press either tune/seek buttons (13 or 14).
- Random Mode: press the random button (19) to play the CD track in a random order. The left side of the display reads “RDM” when random mode is enabled.



- Repeat Mode: press the repeat button (18) to repeat the current CD track continuously. The left side of the display reads “RPT” when the repeat mode is enabled.

Optional Stereo Receiver Troubleshooting

A. Unit will not turn on.

Make sure the spa power is turned on, then check both harness fuses on the back of the unit, making sure they are the proper ratings:

- Yellow memory B+ line (1A fuse); Red ACC line (10A fuse).
- With the spa power off, use a thin rod to press the reset button located under the front panel.

B. Fogged CDs And Lens

This condition may occur when it’s cold. Wipe fogged CDs with a soft cloth. Fogged optical components inside the unit will return to normal operation after an hour in a heated environment.

Optional Wireless Remote Control (Comes standard on Stereo Versions, can be purchased separately.)

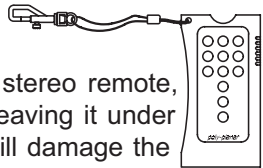

To ensure maximum life of the optional wireless stereo remote, we recommend never submerging it in water or leaving it under the spa cover! Prolonged exposure to moisture will damage the remote.

Optional Wireless Remote Battery Replacement Procedure

Remove the remote from the rubber housing, then remove the protective adhesive seal from the battery door. Depress the hook with a thumbnail and pull outward on the battery door. Replace the depleted battery with a fresh battery, making sure to note the polarity. Re-install the battery door. Replace the adhesive seal material, making sure to cover the entire gap (additional seal material is included, if required). Replace the remote firmly into the rubber housing.

Wireless Remote Control Specifications

Usable range 15 ft. (5m)
 Battery Coin Type, CR2025 or equivalent



Optional Stereo Receiver Specifications\

Tuner

FM usable sensibility	10dBf
FM 50 dB quieting sensitivity	15dBf
FM alternate channel selectivity	90dB
FM stereo separation @ 1kHz	60dBf
AM usable sensitivity	30uV

CD Player

Sampling frequency (8X oversampling)	44.1kHz
Channel separation @1 kHz	80 db
Signal-to-noise ratio	90 dBA
Frequency-to-noise response @ ± 1 dB	20-20 kHz

Audio

Maximum power output (45 watts x 4 channel)	180W
Continuous power, 20-20 kHz, 4 ohms 1% THD	18 x 4
Bass boost/cut	10/100 \pm dB/Hz
Treble boost/cut	10/10+/-dB/kHz

General

Nominal power supply	14.4VDC
Allowable power supply	10.8 - 15.6 VDC
Current consumption	<10Amps
Speaker impedance	4-8 Ohms



10.0 Automatic Filtration Cycles

Your new spa includes a programmable 24-hour circulation pump which filters the water continuously while using less energy than a common 100 watt light bulb! The circulation pump draws water through one of two filter cartridges to effectively remove small debris in your spa. *Note: the 24-hour circulation pump system also supplies heated water to the spa when the heater turns on. See page 30 for programming details.*

The control system activates a programmable “standard” or “economy” skimming/heating cycles to remove larger debris missed by the 24-hour circulation pump filtration system. These cycles utilize pump#1 and the skimmer bag and second filter cartridge to quickly clear “skim” the water of large debris and minimize their “bath-tub ring” effect. Apart from their skimming benefit, each mode also effects the operation of your spa’s heater. Refer to sections 10.1 and 10.2 below for additional information.

10.1 Standard Skimming/Heating Mode

Standard skimming/heating mode is typically selected by customers in cold climates where heatup times are extended due to lower ambient temperatures. In this mode, the water temperature is regulated by the set temperature, 24-hour circulation pump, and heater which turns on as needed. After the programmed set temperature is reached, the heater turns off and the circulation pump continues to operate 24-hours to filter and clean your spa (unless programmed otherwise).

10.2 Economy Skimming/Heating Mode

Economy skimming/heating mode is typically selected by customers in warm climates where heatup times are minimized due to higher ambient temperatures. In this mode, the water temperature is regulated by the set temperature, 24-hour circulation pump, and heater only while a programmed skimming/heating cycle is running (unless in summer logic; see note below). *Note: this mode consumes less energy than the standard mode outlined above.*

10.3 Selecting Standard or Economy Skimming/Heating Mode

Press the **MODE** button to select either “Standard” or “Economy” skimming/heating mode. The control panel’s indicator on the right side of the LCD changes to indicate which mode is selected. When an automatic skimming/heating cycle activates, the LCD screen displays the following message:

**FILTER
CYCLE ON**



Summer Logic: *In warm weather, the water temperature in the hot tub may exceed the set temperature. This condition may occur due to heat transference from the main pump and 24-hour circulation pump. If the water temperature is higher than 95°F (35°C) and rises two degrees above the set temperature, a “Summer Logic” condition occurs that deactivates the circulation pump and ozonator (if equipped). **This safety feature cannot be altered!** The circulation pump and ozonator will remain off until the water temperature cools to the set temperature (except between 12AM-2AM when the circulation pumps runs for it’s mandatory 2-hour “clean-up” cycle). To help prevent a “Summer Logic” condition, it may be necessary to reduce skimming/heating cycle and/or circulation pump run times in warm weather.*

10.4 Preset Skimming/Heating Cycles

Your hot tub comes with four 30-minute skimming/heating cycles already programmed in, beginning at 6:00 a.m., noon, 6:00 p.m., and midnight. You can easily change the start time, or the cycle length for any of these cycles to suit your individual needs by following the steps in section 11.2, page 29.

10.5 Clean-Up Cycle

The clean-up cycle is once per day in both Standard and Economy mode at 12:00 PM for two minutes. This is not user programmable. Pump #2 (and J-385 pump #3) activate for one minute to circulate any water in the plumbing. After 1 minute they go off, then Pump #1 turns on and runs for 1 minute. If the skimming/heating cycle is also set at 12:00 PM, pump #1 will continue to run for the duration of the cycle.



11.0 Programming Instructions

11.1 Adjusting Time of Day

The control system remembers the time of day even in the event of a prolonged power outage. However, it may occasionally be necessary to reset the time of day. For example: if you are not in the Pacific Time Zone you will want to reset the time for your own time zone. (The system will automatically adjust to and from daylight savings time.) To accomplish this, press **DISPLAY, MODE** and **DISPLAY** within five seconds each. A number representing the hour will be displayed, followed by **AM** or **PM**. The hour will advance or decrease each time **WARMER (+)** or **COOLER (-)** is pressed within five seconds. Then, press **DISPLAY** again to display the minutes. Adjust the minutes as necessary by pressing **WARMER (+)** or **COOLER (-)**. After 5 seconds, the display will return to normal.

11.2 Changing Skimming/Heating Cycles

The control system allows you to easily adjust two separate aspects of each of the skimming/heating cycle: 1) the time of day at which each cycle begins; and 2) the duration of each cycle.

To make adjustments, first press **CYCLE** to enter the skimming/heating cycle programming mode. The LCD screen will display the following in the upper right corner:

**ADJUST
FILTER
CYCLE**

START TIME

This means the system is ready to accept your changes to the start time for skimming/heating cycle number one. Simultaneously, the large four-digit display in the center of the screen displays the currently programmed start time for that cycle.

At this point, you have four options. You may:

1. Press **WARMER (+)** or **COOLER (-)** to adjust the start time in increments of 30 minutes.
2. Press **CYCLE** to display and adjust each subsequent skimming/heating cycle start time. With each press, the currently programmed status will be shown in the large four digit display. To adjust any display value, simply press **WARMER (+)** or **COOLER (-)**.
3. Press **SELECT** to move down the menu from Start Time to Duration. With each press, the currently programmed duration will be shown in the large four-digit display. Press **WARMER (+)** or **COOLER (-)** to



adjust duration in increments of 15 minutes.

- 4. Press **DISPLAY** to make the skimming/heating cycle programming characters disappear from the screen and the main display return to showing the water temperature. If no sensor is pressed within 30 seconds, the screen automatically returns to the standard water temperature display.

At any time, you may check the programming of any aspect of any skimming/heating cycle by first pressing **CYCLE** then moving through the menu by pressing either **CYCLE** or **SELECT**. The programming is changed only by pressing **WARMER (+)** or **COOLER (-)** during this process.

11.3 Programming The Change Filter Reminder

Your new spa is equipped with a programmable “Change Filter” reminder that appears on the control panel display after a specified number of days. It is designed to remind you to clean and/or replace your filter cartridge(s) on a regular basis but does not affect spa operation in any way. This reminder must be reset at each filter cleaning interval. It offers a selectable range from 10-120 days or can be disabled. We recommend an initial setting of 30 days, after which you can easily determine whether you need to shorten or lengthen its interval by visually inspecting your filter cartridge. Refer to section 12.1 (page 32) for filter cleaning recommendations.



Programming Instructions

- (1) Press the **CYCLE** sensor six times. The main display reads “FIL” indicating the “Change Filter” display program has been accessed.
- (2) Press **SELECT** sensor once to display currently programmed duration or days elapsed since last filter cleaning interval.
- (3) Press **UP** or **DOWN** sensor to change duration as follows:
0 - 10 - 20 - 30 - 40 - 50 - 60 - 70 - 80 - 90 - 100 - 110 - 120 - OFF
- (4) Press **DISPLAY** sensor once to save changes and return to the standard water temperature display. *Note: If no sensor is pressed within 30 seconds, the screen will automatically return to the standard water temperature display.*

11.4 Programming 24 Hour Circulation Pump Run Time

The control system allows you to easily adjust two separate aspects of circulation pump operation:

- 1. The time of day (start time) the circulation pump begins operating.
- 2. The length of time (duration) the circulation pump operates.



The factory default start time is 12:00AM (Midnight). The default duration is 24 hours. To make adjustments, press the sensor labeled **CYCLE** five times to enter the circulation pump programming mode. The LCD screen will display **ADJUST Circ.** At this time the system is ready to accept your changes.

- Press the **SELECT** sensor once. The previously programmed start time appears on the LCD display.
- Press **WARMER (+)** or **COOLER (-)** sensors to adjust the start time in 30-minute increments.
- Press the **SELECT** sensor to program duration.
- Press **WARMER (+)** or **COOLER (-)** sensors to program the duration time in 1 hour increments.
- Press **DISPLAY** to make the circulation pump programming characters disappear from the screen and the main display return to showing the water temperature. If no sensor is pressed within 30 seconds, the screen will automatically return to the normal water temperature display

Note: In standard skimming/heating mode only, the circulation pump automatically activates if the spa requires heat regardless of the programmed start time and duration.

11.5 Locking Skimming/Heating Cycles

You may keep the skimming/heating cycle programs from being inadvertently altered by electronically “locking” them. To accomplish this, simply press **CYCLE** then, within 30 seconds, press **DISPLAY, MODE** and **WARMER (+)**, within five seconds each.



A padlock symbol will appear on the screen. In this state, the status of the cycle programming may be checked, but may not be altered. To unlock the skimming/heating cycle programming to make changes, simply press **DISPLAY, MODE** and **COOLER (-)** within five seconds each.

11.6 Panel Lock

To help prevent unauthorized use of your spa, the controls incorporate a unique panel locking system which disables the controls on the panel.

To Lock The Panel: Press the **DISPLAY, MODE**, and **WARMER (+)** sensor pads, in order, within five seconds. A padlock symbol will appear on the LCD screen. With the panel locked, none of the components can be turned on and the only settings that can be adjusted are the standard/economy operating mode and changing the time of day. All automatic spa functions will operate normally.





To Unlock The Panel: Press **DISPLAY, MODE**, and **COOLER (-)**, in order, within five seconds. The “lock” symbol will disappear. All sensor pads are now active.

11.7 Temperature Setting Lock

To electronically lock the temperature setting, first enter the “temperature setting” mode by pressing **WARMER (+)** or **COOLER (-)**. Then, within five seconds, press the three sensors described under “Panel Lock” above. This will prevent the temperature setting from being changed by unauthorized persons but all other sensors will remain active.

To unlock the temperature setting so that it can be adjusted, simply follow the instructions above under “**To Unlock The Panel**.”

12.0 Spa Maintenance

Proper and regular maintenance of your spa will help it retain its beauty and performance. Your authorized Jacuzzi Premium dealer can supply you with all the information, supplies, and accessory products you will need to accomplish this.

12.1 Cleaning The Filters

Your Jacuzzi spa is equipped with a skimmer bag and two high – performance filter cartridges located inside the filter skimmer. Fine debris are filtered by the circulation pump drawing water through the skimmer bag and circulation pump cartridge. Larger debris are filtered by the 2-speed pump drawing water through the skimmer bag and main pump cartridge during normal operation and at each skimming/heating cycle. The skimmer bag and filter cartridges provide unsurpassed water quality by tapping surface and suspended particles.

An optional chemical feeder is available through your dealer. When the chemical feeder is in use, remove the chemical feeder during the filter cleaning stage. When turning the cap on the top of this filter, the cap will engage to allow the removal or installation of the filter.



Remove the cap and chemical feeder by rotating the handle to the center of the on and off positions. Then lift the cap from the filter. Reinstall the chemical feeder on the filter prior to the filter installation in the spa. To avoid touching the chemical feeder, it is recommended that latex gloves be used during this process.



All models include filters on their footwell suction covers that prevent debris from entering pump 2, when operating. These filters must remain in place to protect pump 2's plumbing network. They should be cleaned every 2 months, or when weak pump 2 performance is observed. To ensure optimum performance, clean and reuse both cartridges once a month. **ALWAYS TURN POWER TO SPA OFF BEFORE CLEANING THE FILTER CARTRIDGES!** Refer to the filter cleaning/replacement procedure below:

A



TURN POWER TO SPA OFF!



B

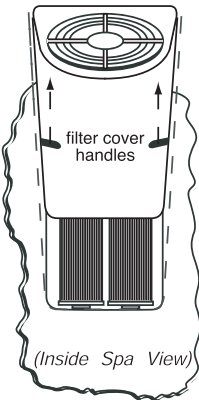

Lift upward on filter cover handles to unsnap and remove it from mating retainer clips.

C

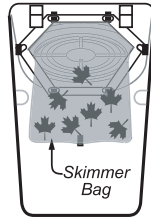

Remove skimmer bag from clips, clean out, then reinstall onto filter cover.

D

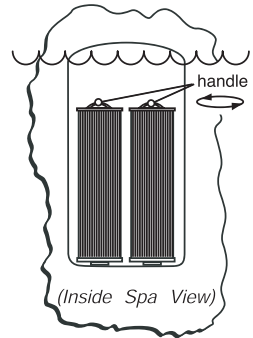

Rotate each filter cartridge handle counterclockwise to unthread from mating wall fitting.

E

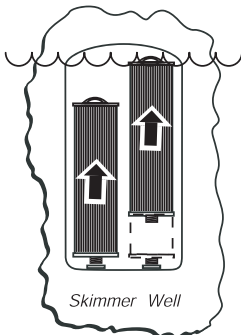

Remove both filter cartridges from skimmer well.

F

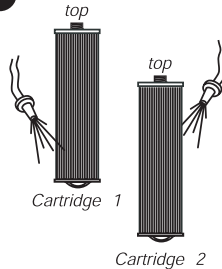

If used, remove the chemical feeder as instructed prior to rinsing the filter cartridges. Rinse debris from filter pleats on each cartridge using a garden hose and high-pressure nozzle. Start at the top and work downward to the handle. Repeat until all pleats are clean.

G

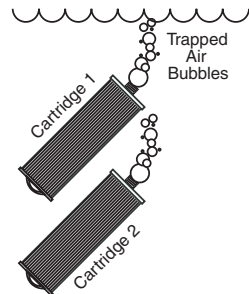

Submerge both filter cartridges in spa. Tilt threaded end upward to remove trapped air bubbles from each cartridge, then keep both cartridges submerged for step H.

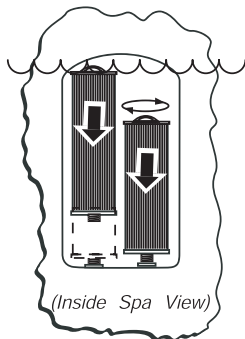

Place each cartridge back into skimmer well*, then rotate each cartridge handle clockwise to thread back into wall fitting. **DO NOT OVERTIGHTEN!**

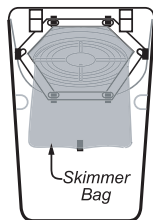

Install clean skimmer bag back onto clips as shown.

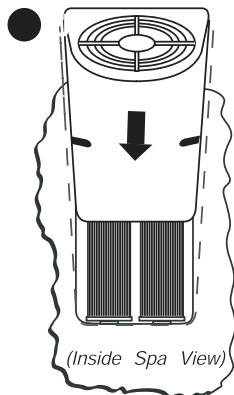

1. Install filter cover with skimmer bag by sliding it down into position over mating spa retainer clips.
2. Turn power to spa back on.

**Note: when replacing the filter cartridges, the chemical feeder must remain on the circulation pump inlet. The circulation pump inlet will have a grid across the wall fitting.*

Periodically, both filter cartridges will need a more thorough cleaning to remove imbedded oils and minerals. For this, we suggest cleaning as illustrated in step "F", followed by soaking the filter overnight in a plastic container filled with a solution of water and specially formulated filter cleanser available from your Jacuzzi dealer. The chemical feeder should be removed during this process. The average life expectancy of each filter is approximately two years with proper care and water quality maintenance. Replacement cartridges may be purchased from your Jacuzzi dealer.

12.2 Draining and Refilling

About every 3 to 6 months, you will want to replace the spa's water. The frequency depends on a number of variables including the amount of use, number of users, attention paid to water quality maintenance, etc. You will know it is time for a change when you cannot control sudsing and/or you can no longer get the normal feel or sparkle to the water even though the key water balance measurements are all within the proper parameters.



WARNING! READ THIS BEFORE DRAINING: To prevent damage to the spa's components, **turn off power to the spa at the circuit breaker before draining it.** Do not turn the power back on until your spa has been refilled.



CAUTION: There are certain precautions to keep in mind when draining your spa. If it is extremely cold, and the spa is outdoors, freezing could occur in the lines or the equipment (see “WINTERIZING”, page 38). On the other hand, if it is hot outdoors, do not leave the spa’s surface exposed to direct sunlight.

To drain your spa, perform the following steps:

1. Turn off power to spa at breaker.
2. Locate the drain valve on the front/lower plastic pan. Hold the larger (rear) body to prevent it from turning, then loosen and remove the front cap to expose the underlying male hose threads.
3. Attach a garden hose to the exposed threads.
4. Gently rotate the larger (rear) valve body 1/3 turn counterclockwise to unlock the drain valve.
5. Pull the larger (rear) body outward to open drain.
6. After the spa drains, perform steps 2-5 in reverse order to close the drain prior to refilling the spa.

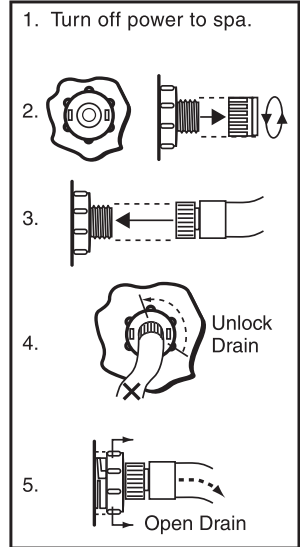

After refilling, turn on power to the spa and follow the steps listed under “Start-Up Instructions.” Always fill your spa through both filter wall fittings (page 11).

12.3 Cleaning The Spa Interior

To preserve the sheen of your spa’s surface, it is crucial that you avoid using abrasive cleaners or cleaners which have adverse chemical effect on the surface. If you are not certain as to the suitability of a particular cleanser, consult your authorized Jacuzzi dealer. Regardless of the cleanser used, use extreme care to assure that no soap residue is left on the surface. This could cause severe sudsing when the spa is refilled.

12.4 Pillow Care

Remove and clean the headrest pillows as needed with soapy water using a cloth or soft-bristle brush. To maintain water resistance and luster, apply a quality vinyl conditioner once a month. Always remove the pillows when adding chemical shock treatment to the spa water. The pillows can be returned to the spa when the sanitizer reading drops below 5 ppm.



CAUTION: Never attempt to remove the pillows by pulling on them! The pillows utilize a bolt-on design that prohibits removal without tools.



To remove pillows:

1. Grasp center pillow insert (A) with finger tips and gently pry outward from pillow base (C).
2. Use a standard screwdriver to loosen and remove mounting bolts (B) from pillow base.
3. Assemble in reverse order after cleaning. **DO NOT overtighten pillow mounting bolts!**

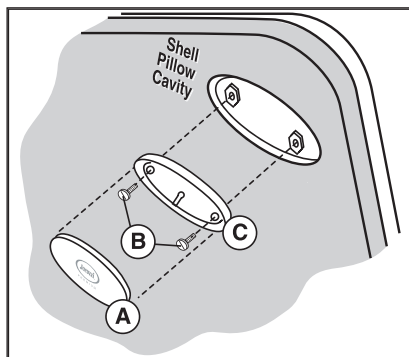

12.5 Maintaining the Cover

Using the Jacuzzi insulating spa cover anytime the spa is not in use will significantly reduce your operating costs, heat-up time and maintenance requirements. To prolong the life of the cover, handle it with care and clean it regularly using mild soap and water. Periodic treatments with a special conditioner developed for Jacuzzi spa covers will help protect against deterioration caused by UV rays from the sun. Never allow anyone to stand or sit on the cover, and avoid dragging it across rough surfaces.

12.6 Maintaining The Cabinet

Your new spa's synthetic cabinet requires little or no maintenance of any kind. To clean, simply wipe cabinet with a clean towel and mild soap solution.



CAUTION: Never spray cabinet with a garden hose for any reason since this action may induce an electrical short in the spa's electrical equipment.

12.7 Winterizing

Your Jacuzzi spa is designed to automatically protect itself against freezing when operating properly. During periods of severe freezing temperatures, you should check periodically to be certain that the electrical supply to the spa has not been interrupted. In extreme, bitter cold weather less than -20 °F (-29 °C), reset the filter cycles for 24-hour operation to protect the spa (i.e. four 6-hour cycles). If you do not intend to use your spa, or if there is a prolonged power outage during periods of severe freezing temperatures, it is important that all water be removed from the spa and equipment to protect against damage from freezing.



For expert winterization of your spa, contact your authorized Jacuzzi dealer. In emergency situations, damage can be minimized by taking the following steps:

1. Follow the directions on page 34 for draining the spa.
2. As the water level drops below the seats, use whatever means necessary to get the water out of the recessed seating areas and into the footwell.
3. When the water level ceases to drop, use whatever means available to remove any remaining water from the footwell.
4. *Turn off power to the spa.*
5. Remove the equipment-side cabinet panels and locate the drain plugs in the front of the pump(s) (Figure-A, Page 10). Remove these plugs to allow the water to drain out of the pumps and heater. *Note: Approximately one to two gallons will be released during this procedure. Use a wet/dry vacuum or other means to keep this from flooding the equipment compartment. Replace the drain plugs.*
6. Loosen the hose clamp on the circulation pump intake behind the control box (Figure-A, Page 10) and pull the hose off (twist hose back and forth while pulling outward). Tip hose down and allow to drain, then reinstall hose and clamp.
7. Re-install cabinet side panels and cover spa so that no casual moisture can enter into it.

Consult your Authorized Jacuzzi dealer if you have any questions regarding winter use or winterizing.

12.8 Restarting Your Spa in Cold Weather

If you want to start up your spa after it has sat empty for a time in freezing temperatures, be aware that the water remaining in certain sections of the piping may still be frozen. This situation will block water flow preventing the

spa from operating properly and possibly damaging the equipment. We recommend you consult your dealer for guidance before attempting to re-start your spa under these conditions.



13.0 Water Quality Maintenance

Maintaining the quality of the water within specified limits will serve to enhance your enjoyment and prolong the life of the spa's equipment. It is a fairly simple task, but it requires regular attention because the water chemistry involved is a balance of several factors. There is no simple formula, and there is no avoiding it. A careless attitude in regard to water maintenance will result in poor and potentially unhealthful conditions for soaking and even damage to your spa. For specific guidance on maintaining water quality, consult your Authorized Jacuzzi dealer who can recommend appropriate chemical products for sanitizing and maintaining your spa.



CAUTION: *Never store spa chemicals inside the spa's equipment bay.*

13.1 pH Control

pH is a measure of relative acidity or alkalinity of water and is measured on a scale of 0 to 14. The midpoint of 7 is said to be neutral, above which is alkaline and below which is acidic. In spa water, IT IS VERY IMPORTANT TO MAINTAIN A SLIGHTLY ALKALINE CONDITION OF 7.2 to 7.8. Problems become proportionately severe the further outside of this range the water gets. A low pH will be corrosive to metals in the spa equipment. A high pH will cause minerals to deposit on the interior surface (scaling). In addition, the ability of the sanitation agents to keep the spa clean is severely affected as the pH moves beyond the ideal range. That is why almost all spa water test kits contain a measure for pH as well as sanitizer.

13.2 Sanitizing

To destroy bacteria and organic compounds in the spa water, a sanitizer must be used regularly. Chlorine and Bromine are the two most popular sanitizers used to date. Many other additives are available for your spa. Some are necessary to compensate for out-of-balance water, some aid in cosmetic water treatment and others simply alter the feel or smell of the water. Your Authorized Jacuzzi dealer can advise you on the use of these additives.

CAUTION: *Do not use chlorine tablets (Trichlor) in your spa. This chemical can have an extremely corrosive effect on certain materials in the spa. Damage caused by use of this chemical, or improper use of any chemicals, is not covered under the spa's warranty.*



13.3 Optional CD Ozone Water Maintenance System

If you have elected to have your spa equipped with the optional Jacuzzi CD Ozone water purification system you will find that your water stays fresh and clear with significantly less chemical sanitizer usage. You will also probably be able to go longer between complete spa drainings. The CD ozone unit operates in conjunction with the 24hr circulation pump.

13.4 Summer Logic

When the actual spa water temperature reaches up to 2 °F (1 °C) above the set temperature, the spa goes into “summer logic.” The circulation pump will turn off automatically to avoid adding additional heat to the water, eventually creating an overheat condition. This setting is not user-programmable.

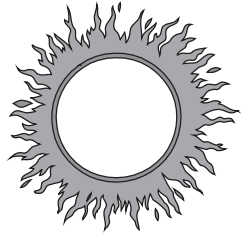

Note: The summer logic does not take effect until the spa water temperature reaches 95 °F (35 °C). This condition is more likely in excessively hot weather. Remember, the spa’s ability to cool is directly affected by the ambient temperature. An excessively hot ambient temperature may prevent the spa from cooling down because it’s fully insulated construction is designed to retain heat and to minimize operating costs.



14.0 Troubleshooting - Display Messages

There are a number of unique functions designed into your Jacuzzi spa to protect it from damage and/or to aid in troubleshooting. Following is a listing of all the possible messages along with their meanings:

MESSAGE

MEANING

OH

Overheat Protection (Heater is deactivated, pump's low speed is activated). Water temperature is above acceptable limits. ***Do not enter the water!***

To correct condition:

- Remove spa cover and allow your spa to cool down.
- Set the spa in Economy Mode. Do not keep the temperature setting too low as to keep the circulation pump in Summer Logic.
- If the condition persists contact your authorized dealer.

COOL

If the spa water is more than 20 °F (-7 °C) cooler than the temperature setpoint, the 24hr circulation pump and heater will automatically activate to provide freeze protection. The spa will stay in this mode until the water temperature reaches 15 °F (-9 °C) below the set temperature. No corrective action is necessary.

FLO*

FLOW SWITCH (Heater is deactivated. Pump may also be deactivated). Proper flow of water is inhibited or a flow switch has malfunctioned. Check for proper water level and for a clogged circulation pump filter cartridge (Sec. 12.1, Page 32-34). Contact your dealer or service center.

****NOTE: THIS MESSAGE CAN ALSO APPEAR IF THE PUMP HAS NOT REGAINED PRIME AFTER THE SPA HAS BEEN DRAINED AND REFILLED. IF YOU SUSPECT THAT THIS IS THE CASE, SEE THE INSTRUCTIONS ON PAGE 42 UNDER "PUMP DOES NOT OPERATE..."***

Hold

Panel sensors have been pressed too many times in a short period of time. Because this could cause excessive wear on equipment components, panel sensors are temporarily deactivated. Panel sensors will automatically re-activate if no sensor is pressed for 30 seconds.



HOT

Circuit board temperature has exceeded acceptable limit. This message will disappear when the circuit board temperature drops below acceptable limit. If condition persists, provide shade for equipment side of spa.

ICE
ICE2

FREEZE PROTECTION

A potential freeze condition has been detected. No action is required. Pump(s) operate until the spa is out of danger. *Note: This error commonly occurs when the spa is first filled because tap water is often very cold.*

PnL

Communication between the control panel and/or remote control panel and circuit board is faulty. Contact your dealer or service center.

“WATCHDOG” (spa is deactivated)

A problem has been detected which could cause damage to the spa or its components. Contact your dealer or service center.

Sn1

OPEN SENSOR (heater disabled) OR SHORTED SENSOR (spa is deactivated) The high-limit temperature sensor is non-functional. This must be repaired only by a dealer or authorized service center.

Sn3

OPEN OR SHORTED SENSOR (heater disabled) The main sensor is non-functional. This must be repaired only by a dealer or authorized service center.

FL02

CLOSED OR SHORTED FLOW SWITCH ON SYSTEM STARTUP (system disabled) Flow switch is non-functional. This must be repaired only by a dealer or qualified service organization.



15.0 Troubleshooting - Procedures

In the unlikely event your spa is not working the way you believe it should, please first review all installation and operating instructions in this manual and check the message on the panel display; second, if you are still not satisfied it is working properly, please follow the appropriate troubleshooting instructions.

PROBLEM

NONE OF THE COMPONENTS OPERATE (i.e. pump, light)

PROCEDURE

Check the control panel lights.

1. If there are letters or symbols displayed on the screen, refer to the previous section to determine meaning and action required.
2. If nothing appears on the screen:
 - a. Check the household circuit breaker.
 - b. Contact you dealer or authorized service center.

PUMP DOES NOT OPERATE BUT LIGHT DOES

Depress "JETS" sensor.

1. If no sound is detected or if a "buzzing" sound is detected, turn off power to the spa and contact your dealer or authorized service center.
2. If motor operates but no water flows to jets:
 - a. Pump may not be properly primed. See instructions below.
 - b. Contact dealer or authorized service center.

Pump Priming Instructions: *TURN SPA OFF!*

Remove waterfall side filter cartridge and insert end of garden hose into its fitting. Seal-off pipe opening around hose using a large, clean rag and turn on maximum water flow through the hose. After about 30 seconds, turn off water, remove hose and rag, reinstall filter and activate pump #1 on high speed. Another method of priming the spa's pump(s) is as follows:

1. **Turn off the power to the spa.**
2. Remove the handle from diverter valve #1 (Sec, 8.3, Page 14)
3. Loosen the diverter valve cap slightly (counterclockwise), listening for the air to seep out.
4. Tighten the cap finger-tight, replace the diverter valve handle, and turn the spa's power back on.



Note: This method must be used for the single speed pump(s) in all spas because pump #2 (and J-385 pump #3) are not connected to the filter.



CAUTION: *If freezing conditions exist and pump is not operational, take measures to protect the system from freeze damage. See "Winterizing" (Page 36).*

POOR JET ACTION

1. Make certain the pump is on high speed.
2. Check position of diverter valve
3. Open air control for selected jet system.
4. Check for adequate water level.
5. Check for dirty filter cartridge.
6. Check for dirty filters on both pump #2 footwell suction covers (Page 14).

WATER IS TOO HOT.

1. Reduce thermostat setting.
2. Reduce skimming/heating cycle length. Even with heater off, water temperature can increase from prolonged pump operation (Page 30).

NO HEAT

1. Check thermostat setting.
2. Keep the cover in place while heating.
3. Verify which skimming/heating mode is selected, standard or economy (Page 26).
4. If "heater on" indicator is lit, but no temperature rise is experienced after a reasonable period of time, contact your dealer or authorized service center.

Should checking the above steps fail to correct the problem, please call your dealer so that he may arrange service.

Jacuzzi builds the best spas in the industry. Nonetheless, we are always striving to improve the quality and features of our products. Your input as a Jacuzzi spa owner is a cherished part of this process. If you have any comments or suggestions, or if you wish to be informed on any new products for your spa, please write to us.

CONGRATULATIONS on your good taste and welcome to the happiest and most relaxed family in the world!

16.0 Wiring Diagram

J-355/J-365/J-375 Models (USA/Canada, 240VAC, 60Hz)

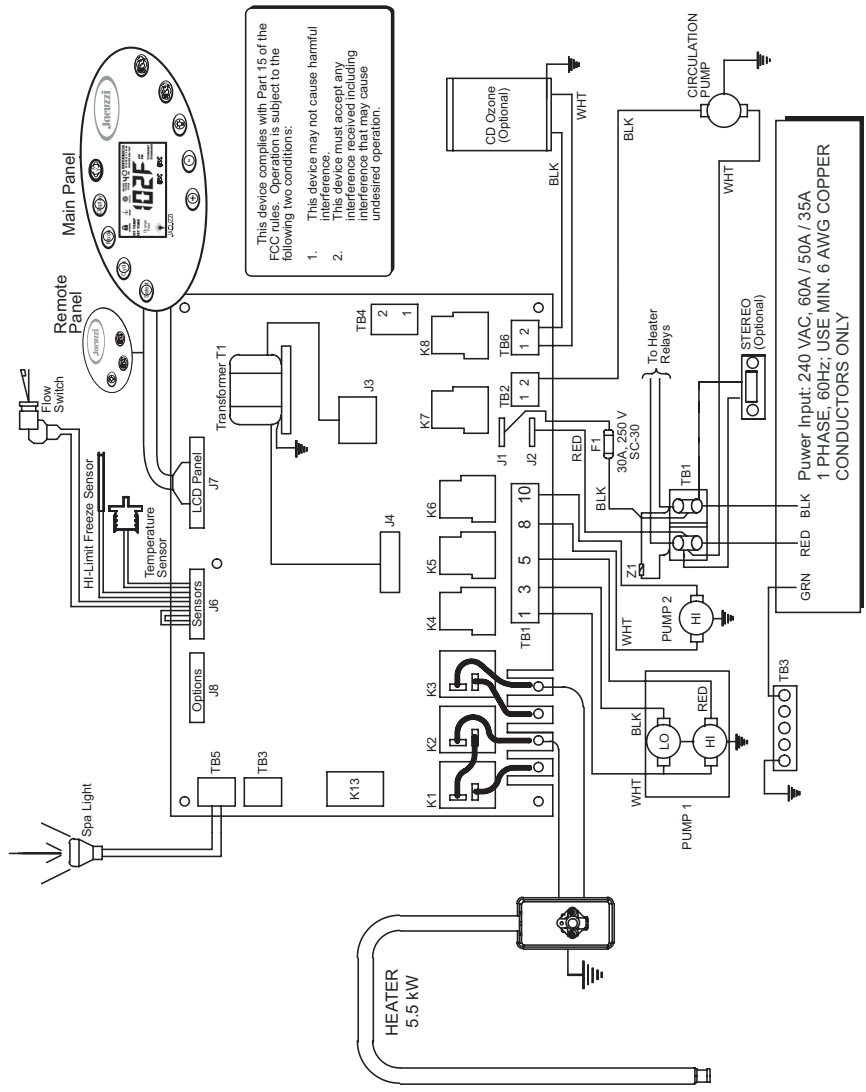

This device complies with Part 15 of the FCC rules. Operation is subject to the following two conditions:

1. This device may not cause harmful interference.
2. This device must accept any interference received including interference that may cause undesired operation.

17.0 Wiring Diagram

J-385 Models (USA/Canada, 240VAC, 60Hz)

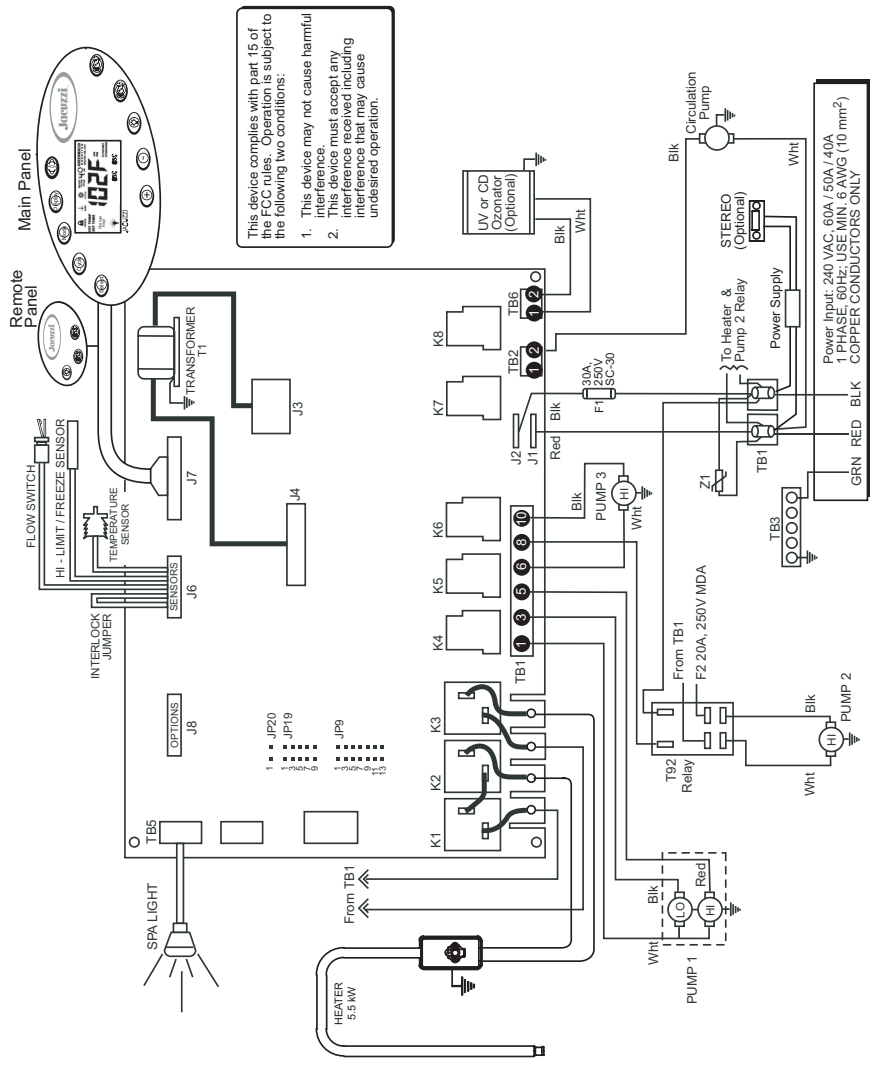

This device complies with part 15 of the FCC rules. Operation is subject to the following two conditions:

1. This device may not cause harmful interference.
2. The user must accept any interference received, including interference that may cause undesired operation.



18.0 Wiring Diagram

J-355/J-365/J-375 Models (Export, 230VAC, 50Hz)

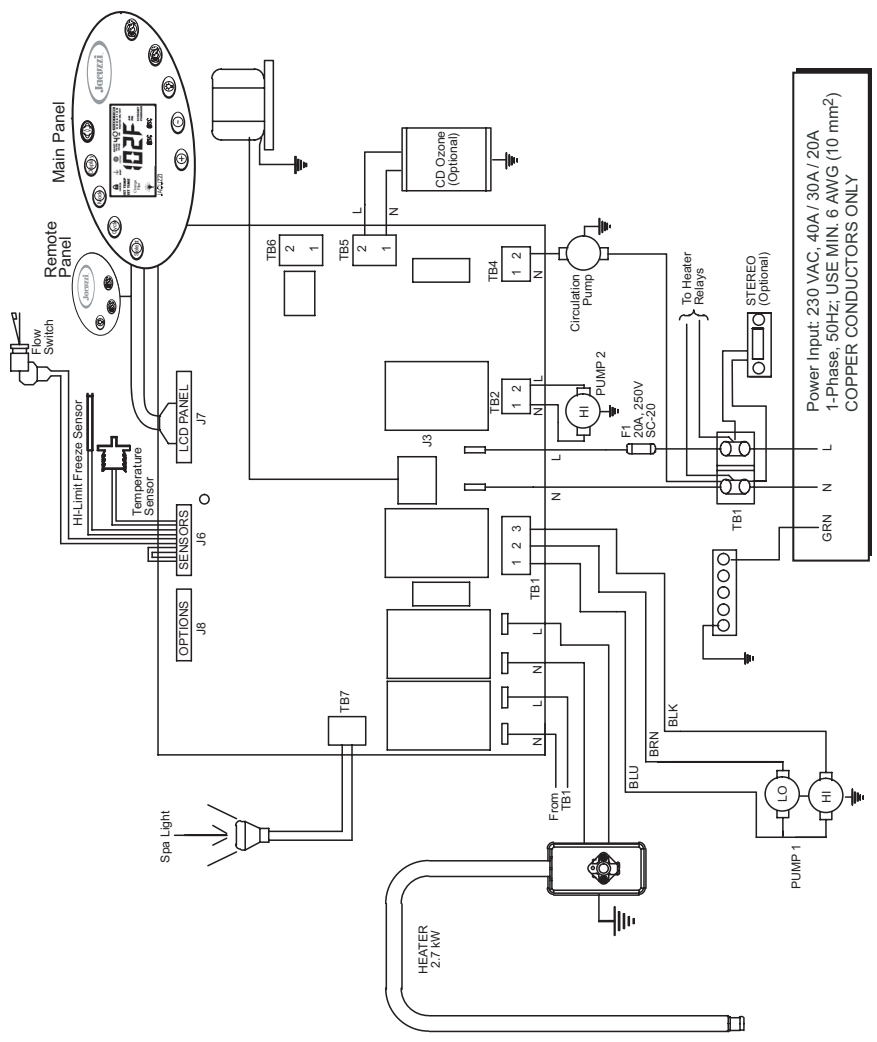

19.0 Wiring Diagram

J-385 Models (Export, 230VAC, 50Hz)

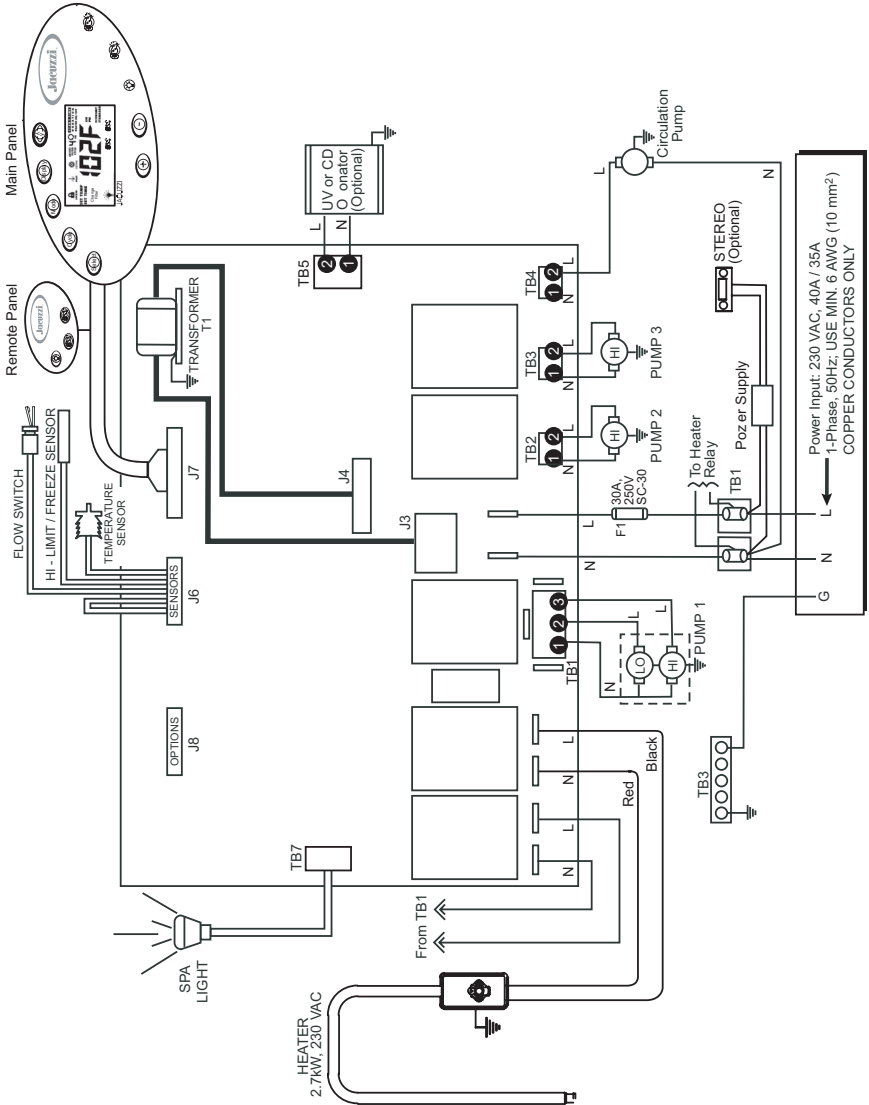



20.0 Typical Spa Wiring Diagrams A-B US/Canada 60Hz Models Only

