

Utopia & Aquatic Melodies Series
Owner's Manual

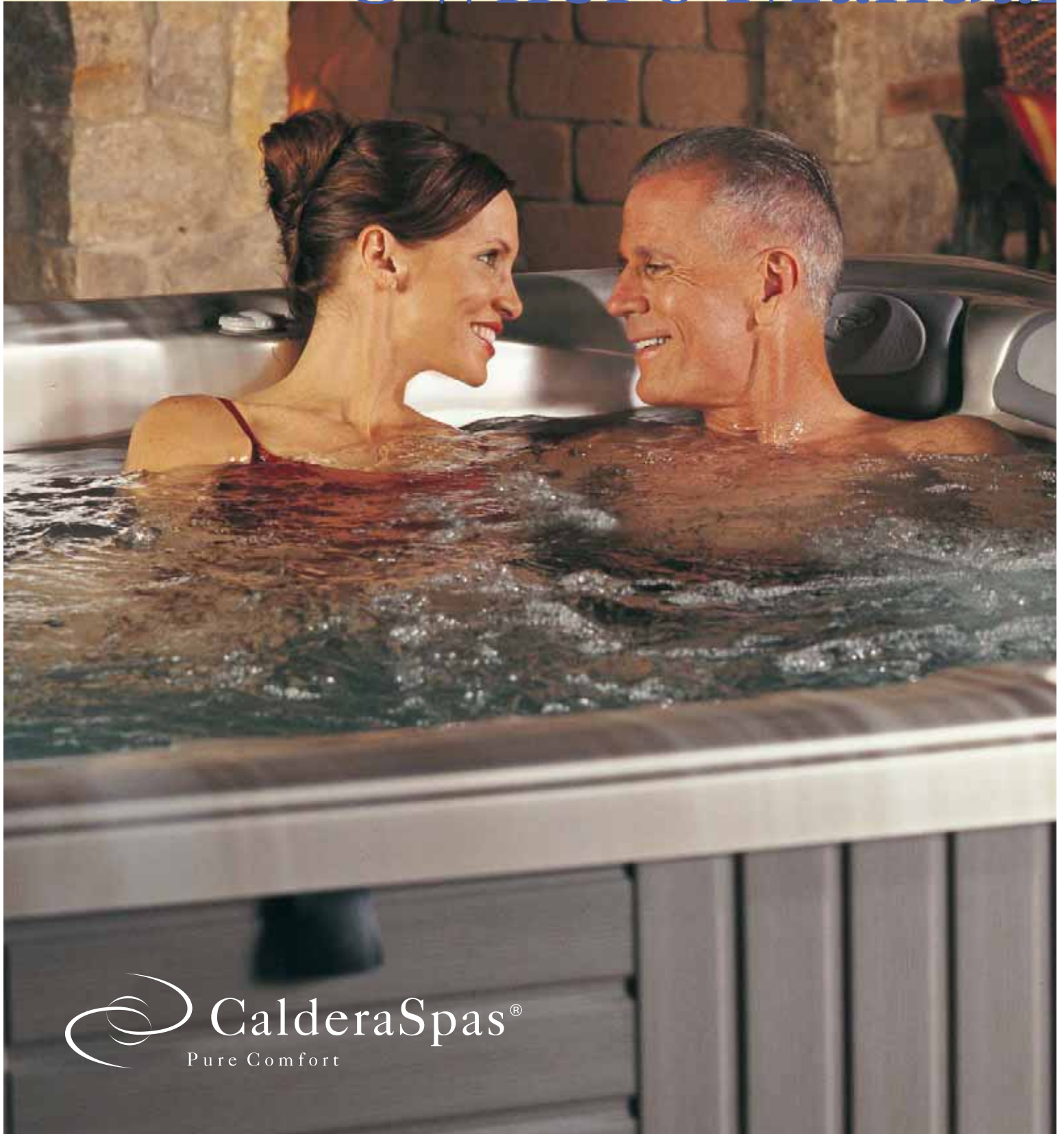

 **CalderaSpas®**
Pure Comfort

• Geneva™ • Niagara® • Tahitian® • Elation® • Aspire™

WELCOME



Watkins® Manufacturing Corporation congratulates you on your decision to enjoy the finest spa available... Welcome to the growing family of Caldera® spa owners.

OWNER'S MANUAL

This Owner's Manual will acquaint you with the operation and general maintenance of your new spa. We suggest that you take some time to carefully review all sections. Please keep this manual available for reference.

If you have any questions about any aspect of your spa's set-up, operation or maintenance, contact your authorized Caldera dealership. They are trained professionals who are familiar with the product as well as new spa ownership concerns. Their expertise will facilitate the enjoyment of your new Caldera spa.

The serial number/identification label is located within the equipment compartment of your Caldera spa. The serial number should also be documented on the delivery receipt from your dealer.

IMPORTANT: Watkins Manufacturing Corporation reserves the right to change specifications, or design, without notification and without incurring any obligation.

DATE PURCHASED: _____

DATE INSTALLED: _____

DEALER: _____

ADDRESS: _____

TELEPHONE: _____

SPA MODEL/SERIAL NUMBER: _____

COVER SERIAL NUMBER: _____

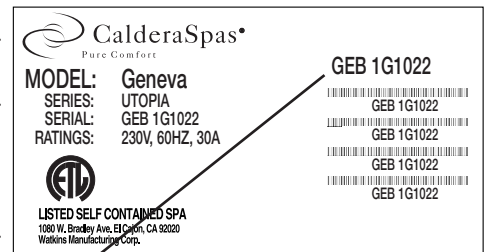

NOTE: This is an example. Your spa's label will contain different information. Peel off top sticker and place here.

In most cities and counties, permits will be required for the installation of electrical circuits or the construction of exterior surfaces (decks and gazebos). In addition, some communities have adopted residential barrier codes which may require fencing and/or self-closing gates on the property to prevent unsupervised access to a pool (or spa) by children under 5 years of age. Your Caldera spa is equipped with a locking cover that meets the ASTM F1346-91 Standard for Safety Covers, and as a result, is usually exempt from most barrier requirements. As a general practice, your local Building Department will inform you of any applicable barrier requirements at the time a permit is obtained for the installation of an electrical circuit. Your Caldera dealer can provide information on which permits may be required.

TABLE OF CONTENTS

SAFETY INSTRUCTIONS

- Important Safety Instructions 1
- Important Spa Instructions 3

INSTALLATION

- Site Preparation 3
- Outdoor and Patio Installation 3
- Deck Installation 4
- Indoor/Basement Installation 4
- Spa Leveling Preparation 4
- Spa Cover Installation 4

CONTROLS AND EQUIPMENT

- Utopia Geneva™ 5
- Utopia Niagara® 6
- Utopia Tahitian® 7
- Aquatic Melodies® Elation® 8
- Aquatic Melodies® Aspire™ 9

ELECTRICAL INSTALLATION

- Electrical Requirements and Precautions 10
- 230 Volt Permanently Connected 10

START-UP AND REFILL PROCEDURES ... 12

CUSTOMIZING YOUR MASSAGE

- Diverter Valves 13
- Acquarella™ Waterfall Valve 13
- Atlas® Neck Jet Valve 13
- Air Controls 13
- Hydro Jets 13
- Air Jets 14

JET MENU

- Utopia Geneva Jet Menu 15
- Utopia Niagara Jet Menu 16
- Utopia Tahitian Jet Menu 17
- Aquatic Melodies Elation Jet Menu 18
- Aquatic Melodies Aspire Jet Menu 19

OPERATING INSTRUCTIONS

- Control Panels 20
- Locking Features 20
- Main Control Panel Buttons and Display 21
- Auxiliary Control Panel Buttons 22
- Aquatic Melodies® Surround Sound System 23

EQUIPMENT COMPARTMENTS

- Jet Pump Side 24
- Controls Side 25

MAINTENANCE

- Filter Lid Removal and Replacement 26
- Filter Maintenance 26
- Filter Cartridge Removal and Cleaning Instructions 26
- Diverter Valve Maintenance 26
- VersaSage® Jets Maintenance 26
- Draining Your Spa 27
- Winterizing Your Spa 27
- Care of the Spa Pillows 28
- Care of the Exterior 28
- Care of the Spa Cover 28

WATER QUALITY AND MAINTENANCE

- General Information 29
- Methods for Testing the Spa Water 29
- The Watkins® Spa Water Maintenance Program 30
- Chlorine (Sodium Dichlor) 32
- Monarch® Ozone System 34
- Common Water Chemistry Questions 35
- Water Terminology 35
- Spa Water Maintenance Troubleshooting Guide 36

SERVICE

- Miscellaneous Service Information 37
- Acts Invalidating Warranty 37
- Disclaimers 37
- Watkins Customer Service 37

SPA TROUBLESHOOTING 38

SPA SPECIFICATION Back Cover

SAFETY INSTRUCTIONS

IMPORTANT SAFETY INSTRUCTIONS

READ AND FOLLOW ALL INSTRUCTIONS

AVOIDING THE RISK TO CHILDREN

DANGER:

- **RISK OF CHILD DROWNING.** Extreme caution must be exercised to prevent unauthorized access by children. To avoid accidents, ensure that children cannot use a spa unless they are supervised at all times.

WARNING:

- To reduce the risk of injury, do not permit children to use this spa unless they are closely supervised at all times.
- To reduce the risk of injury, lower water temperatures are recommended for young children. Children are especially sensitive to hot water.

DO:

- Make sure you always lock the child resistant locks after using the spa for your children's safety. Every Caldera® spa is equipped with a locking cover that meets the ASTM F1346-91 Standard for Safety Covers.
- Test the water temperature with your hand before allowing children to enter the spa to be sure that it's comfortable. Children are especially sensitive to hot water.
- Remind children that wet surfaces can be very slippery. Make sure that children are careful when entering, or exiting the spa.

DON'T:

- Allow children to climb onto the spa cover.
- Allow children to have unsupervised access to the spa.

AVOIDING THE RISK OF ELECTROCUTION

Risk of electrocution

- Connect only to a grounded source.
- Do not bury the power cord. A buried power cord may result in death, or serious personal injury due to electrocution if direct burial-type cable is not used, or if improper digging occurs.
- A ground terminal (pressure wire connector) is provided on the control box inside the unit to permit connection of a minimum No. 10 AWG solid copper bonding conductor between this point and any metal equipment, metal water pipe, metal enclosures of electrical equipment, or conduit within five feet (1.5 m) of the unit as needed to comply with local requirements.

WARNING:

- To reduce the risk of electrical shock, replace a damaged cord immediately. Failure to do so may result in death or serious personal injury due to electrocution.
- Your spa is provided with a Ground Fault Circuit Interrupter for user and equipment protection. To ensure proper operation of this important safety device, test according to the following instructions per electrical configuration.

230 volt, permanently installed models:

- A ground terminal is provided on the terminal block located inside the control box. To reduce the risk of electric shock, connect this terminal to the grounding terminal of your electrical service or supply panel with a continuous green, insulated copper wire. The wire must be equivalent in size to the circuit conductors supplying the equipment. In addition, a bonding terminal (pressure wire connector) is provided on the outside of the control box for bonding to local ground points. To reduce the risk of electric shock, this connector should be bonded with a No. 10 AWG solid copper wire to any metal ladders, water pipes, or other metal within 5 feet (1.5 m) of the spa to comply with local requirements. The means of disconnection must be readily accessible, but must be installed at least 5 feet (1.5 m) from the spa.
- Your spa is provided with a suitably rated circuit breaker to open all ungrounded supply conductors.
- Your spa uses ground fault circuit interrupters in the electrical subpanel. Before each use of the spa and with the unit operating, push the TEST button on each breaker. The switch should click over to the "Trip" position. Wait 30 seconds and reset each GFCI breaker by switching it completely off and then completely on. The switch should then stay on. If either of the interrupters does not perform in this manner, it is an indication of an electrical malfunction and the possibility of an electric shock. Disconnect the power until the fault has been identified and corrected.

DANGER: RISK OF ELECTRICAL SHOCK

- Install spa at least 5 feet (1.5 m) from all metal surfaces. A spa may be installed within 5 feet of a metal surface if each metal surface is permanently connected by a minimum No. 10 AWG solid copper conductor attached to the wire ground connector on the terminal box that is provided for this purpose if in accordance with National Electrical Code ANSI/NMFA70-1993.
- Do not permit any electrical appliances, such as a light, telephone, radio, or television within 5 feet (1.5 m) of a spa. Failure to maintain a safe distance may result in death, or serious personal injury due to electrocution, if the appliance should fall into the spa.
- Install your spa in such a way that drainage is away from the electrical compartment and from all electrical components.

SAFETY INSTRUCTIONS

DO:

- Be sure your spa is connected to the power supply correctly - use a licensed electrical contractor.
- Disconnect the spa from the power supply before draining the spa or servicing the electrical components.
- Test the Ground Fault Circuit Interrupter(s) before each use.

DON'T:

- Use the spa with the equipment compartment door removed.
- Place electrical appliances within 5 feet (1.5m) of the spa.
- Attempt to open the electrical control box. There are no user serviceable parts inside.

RISKS TO AVOID

⚠ DANGER: RISK OF INJURY

- To reduce the risk of injury to persons, DO NOT remove floating weir, basket and filter located in the filter compartment while the spa is running.
- Never replace a suction fitting with one rated less than the flow rate marked on the original suction fitting.
- There is a danger of slipping and falling. Remember that wet surfaces can be very slippery. Take care when entering or exiting the spa.
- Never operate spa if the suction fittings are broken or missing.
- People with infectious diseases should not use the spa.
- Keep any loose articles of clothing or hanging jewelry away from rotating jets or other moving components.

Increased side effects of medication

- The use of drugs, alcohol or medication before or during spa use may lead to unconsciousness with the possibility of drowning.
- Persons using medications should consult a physician before using a spa; some medication may cause a user to become drowsy, while other medication may affect heart rate, blood pressure, and circulation.
- Persons taking medications which induce drowsiness, such as tranquilizers, antihistamines, or anticoagulants should not use the spa.

Health problems affected by spa use

- Pregnant women should consult a physician before using spa.
- Persons suffering from obesity, or with a medical history of heart disease, low or high blood pressure, circulatory system problems, or diabetes should consult a physician before using spa.

Unclean water

- Keep the water clean and sanitized with correct chemical care. The recommended levels for your Caldera® spa are:

Free Available Chlorine (FAC):	3.0-5.0 ppm
Water pH:	7.4-7.6
Total Alkalinity:	125-150 ppm
Calcium Hardness:	150-200 ppm

(Refer to Water Quality and Maintenance section for complete instructions.)

IMPORTANT: Turn on the clean cycle when adding ANY spa water chemicals into or in front of the filter compartment.

- Clean the filter cartridge at least monthly to remove debris and mineral buildup which may affect the performance of the hydromassage jets, limit the flow, or trip the high limit thermostat, which will turn off the entire spa.

AVOIDING THE RISK OF HYPERTHERMIA

Prolonged immersion in hot water can result in HYPERTHERMIA, a dangerous condition which occurs when the internal temperature of the body reaches a level above normal (98.6°F). The symptoms of hyperthermia include unawareness of impending hazard, failure to perceive heat, failure to recognize the need to exit the spa, physical inability to exit the spa, fetal damage in pregnant women, and unconsciousness resulting in a danger of drowning.

⚠ WARNING:

The use of alcohol, drugs, or medication can greatly increase the risk of fatal hyperthermia in hot tubs and spas.

TO REDUCE THE RISK OF INJURY:

- The water in the spa should never exceed 104°F. Water temperatures between 100°F and 104°F are considered safe for a healthy adult. Lower water temperatures are recommended for extended use (exceeding ten minutes) and for young children. Extended use can cause hyperthermia.
- Pregnant or possibly pregnant women should limit spa water temperatures to 100°F. Failure to do so may result in permanent injury to your baby.
- Do not use spa immediately following strenuous exercise.

AVOIDING THE RISK OF SKIN BURNS:

SAFETY INSTRUCTIONS

- To reduce the risk of injury, before entering a spa the user should measure the water temperature with an accurate thermometer, since the tolerance of temperature-regulating devices may vary by as much as $\pm 5^{\circ}\text{F}$.
- Test the water with your hand before entering the spa to be sure it's comfortable.

SAFETY SIGN

Each Caldera® spa is shipped with a SAFETY SIGN in the owner's package. The sign, which is required as a condition of Product Listing, should be permanently installed where it is visible to the users of the spa. To obtain additional SAFETY SIGNS, contact your Caldera dealer and request Part #003021.

IMPORTANT SPA INSTRUCTIONS

The following contains important spa information, and we strongly encourage you to read and apply them.

DO:

- Use and lock the cover when the spa is not in use, whether it is empty or full.
- Follow the Spa Care and Maintenance recommendations stated in this manual.
- Use only approved accessories and recommended spa chemicals and cleaners.

DON'T:

- Leave the Caldera spa exposed to the sun without water or the cover in place. Exposure to direct sunlight can cause solar distress of the shell material.
- Roll or slide the spa on its side. This will damage the siding.
- Lift or drag the vinyl cover by using the cover lock straps; always lift or carry the cover by using the handles.
- Attempt to open the electrical control box. There are no user serviceable parts inside. Opening of the control box by the spa owner will void the warranty. If you have an operational problem, carefully go through the steps outlined in the Troubleshooting section. If you are not able to resolve the problem, contact your authorized Caldera dealer. Many problems can easily be diagnosed over the telephone by an Authorized Service Technician.

SAVE THESE INSTRUCTIONS

INSTALLATION

SITE PREPARATION

You probably have a spot picked out for your new spa, whether it's indoors or outdoors, on a patio or on a deck. Just make sure you check the following:

- Always put your spa on a structurally sound, level surface. A filled spa can weigh a great deal. Make certain that the location you choose can support the weight of your filled spa.
- Don't forget to level your spa before filling it. (See the Spa Leveling Preparation section of this manual.)
- Locate your equipment compartment, which houses all of the electrical components, in a place where water will drain away from it. Allowing water into the equipment compartment can damage the electronics, or may result in tripping your house's circuit breaker.
- Leave yourself easy access to the circuit breakers in the subpanel.
- Never let water get into the subpanel. Your 230 volt spa's subpanel is rain-tight when installed correctly with the door closed. Periodically check these conditions and correct any flaws if detected.
- Leave access to the equipment compartment for periodic spa care and maintenance.

⚠ WARNING: Damage to the spa's equipment compartment components or internal plumbing as a result of rodent infestation is NOT covered under your warranty!

OUTDOOR AND PATIO INSTALLATION

No matter where you install your new spa, it's important that you have a solid foundation to support it. Structural damage to the spa, resulting from incorrect installation, or placement on an inadequate foundation, is not covered under the spa's limited warranty.

If you install the spa outdoors, we recommend a reinforced concrete pad at least four inches thick. The reinforcing rod or mesh in the pad should be attached to a bond wire.

DECK INSTALLATION

INSTALLATION

To be certain your deck can support your spa, you must know the deck's maximum load capacity. Consult a qualified building contractor or structural engineer. To find the weight of your spa, its contents and occupants, refer to the Spa Specification chart on back page. This weight per square foot must not exceed the structure's rated capacity, or serious structural damage could result.

INDOOR/BASEMENT INSTALLATION

Be aware of some special requirements if you place your spa indoors. Water will accumulate around the spa, so flooring materials must provide a good grip when wet. Proper drainage is essential to prevent a build-up of water around the spa. When building a new room for the spa it is recommended that a floor drain be installed. The humidity will naturally increase with the spa indoors. Water may get into woodwork and produce dry rot, mildew, or other problems. Check for airborne moisture's effects on exposed wood, paper, etc. in the room. To minimize these effects, it is best to provide plenty of ventilation to the spa area. An architect can help to determine if more ventilation must be installed.

Caldera spas are equipped with a jet pump shroud to remove excessive heat from the equipment compartment. Find this vent and be sure the vent is not blocked by anything, including carpeting.

Your Caldera dealer can help you with local information such as zoning regulations and building codes.

⚠ WARNING: Please keep the area around your spa well ventilated when it is installed indoors or in a confined area. Inadequate ventilation around the spa could cause a build-up of a higher-than-normal concentration of spa chemicals and/or bacterial fragments. These dispersed spa chemicals and/or bacterial fragments can be inhaled, and may result in breathing difficulties or lung damage in certain people suffering from a compromised immune system or respiratory infection. If you or other bathers are affected by this condition, please seek medical attention as soon as possible.

In addition to the above, properly clean and maintain your spa as follows:

- Follow all procedures in this owner's manual and printed instructions on all water care (chemical) products packaging.
- Test the water regularly to ensure proper levels of sanitizers, pH, and other water care requirements.
- Drain, clean, and refill your spa with fresh water on a regular schedule, and in accordance with this owner's manual.
- Clean the filter at least once per month.
- Check to make sure you have proper circulation throughout your spa water system.
- Have spa users bathe before entering the spa water.

SPA LEVELING PREPARATION

Concrete sloped at 1 inch per 10 feet is preferred so that rain water and water spillover will run off and not puddle underneath the spa (water under the spa for long periods of time may cause the wood to deteriorate). Other options are brick, stepping stone, or blocks.

It is important to note that soft surfaces, even when stepping stones are used to evenly distribute the weight of the spa, will have a tendency to settle, thus resulting in an unlevelled spa.

NOTE: Placing the spa on grass or dirt may increase the amount of debris which is inadvertently brought into the spa water and may cause harm to your equipment as well as the spa surface, which is not covered under warranty.

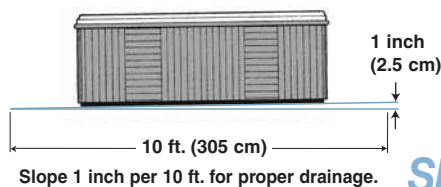

SPA COVER

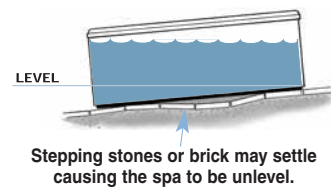

INSTALLATION

- Place the cover squarely on the spa.
- Position the tie-down locks included with your cover on the side of the spa so that they are easily reached by the cover tie-down straps. Allow for about 1/2" to 3/4" slack in the straps to make it easy to insert straps into locks and to compensate for vinyl shrinkage in cold weather.
- Attach the locks with the screws provided and insert the cover tie-down straps into the locks.

NOTE: Keeping the cover in place any time the spa is not in use will reduce the amount of time the heater operates, thereby minimizing operating costs.

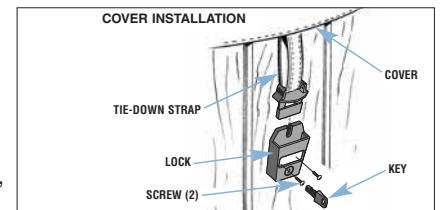

DANGER. RISK OF INJURY.

- Never leave a spa uncovered or unattended.
- Never leave a spa cover unlocked.
- Do not stand, sit, or lie on the cover.

⚠ WARNING

Watkins Manufacturing Corporation recommends that the Caldera® spa be installed above ground. Lowering the top of the spa to ground level, or employing decking which raises standing level toward the top of the spa substantially increases the hazard of accidental entry. Consult a licensed building contractor to design or evaluate your custom decking requirements.

CONTROLS AND EQUIPMENT

UTOPIA GENEVA™

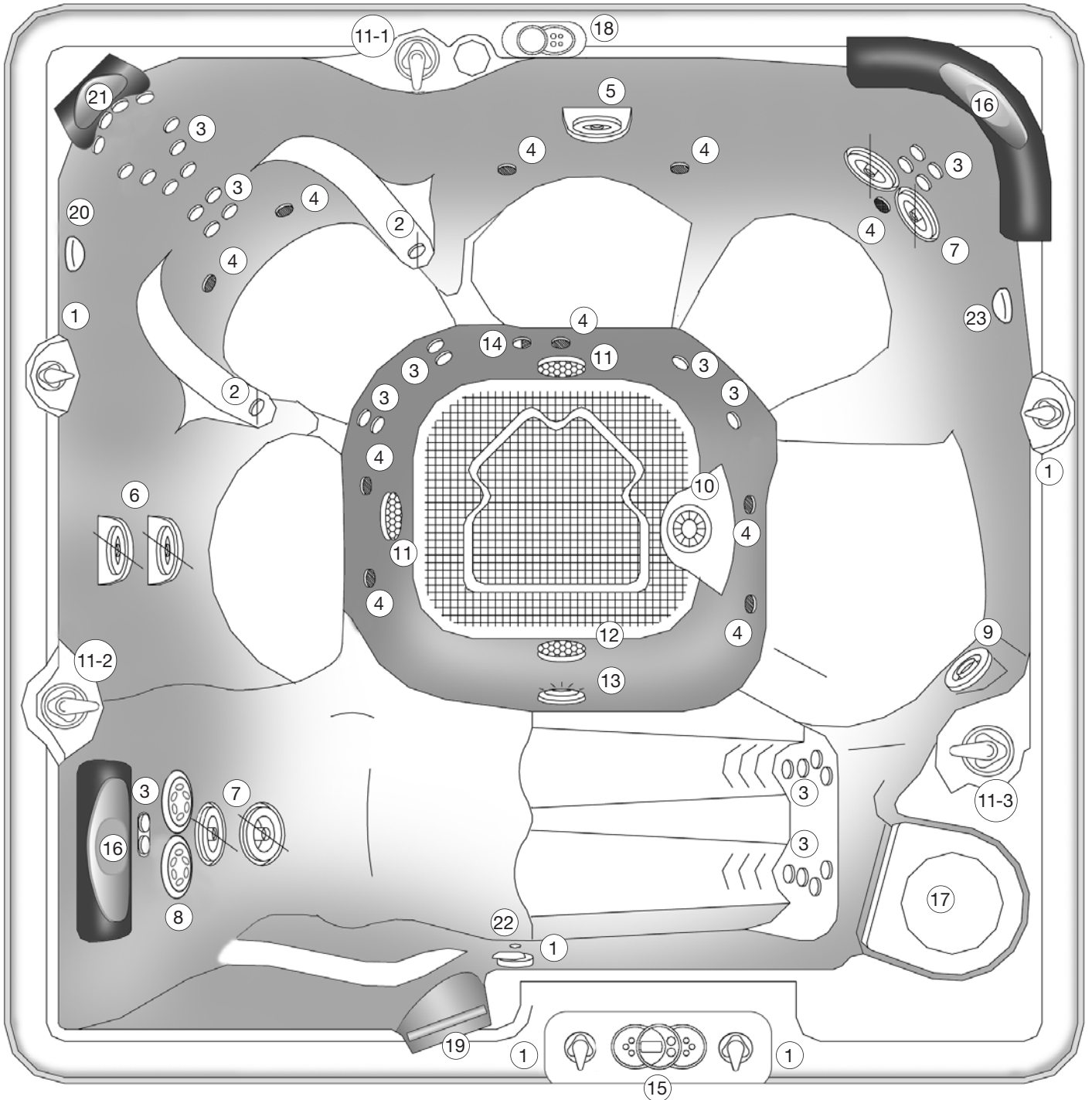

OVERHEAD VIEW

- | | | | |
|-------------------------|--------------------|------------------------|---------------------------------|
| 1. Air Control | 7. VersaSage® Jet | 13. Light | 19. Grab Rail |
| 2. Euro-Pulse® Jet | 8. OrbiSage™ Jet | 14. Ozone Jet | 20. Atlas® Neck Jet Valve |
| 3. Euro Directional Jet | 9. Whirlpool Jet | 15. Control Panel | 21. Atlas Neck Jet Pillow |
| 4. Air Jet | 10. Euphoria® Jet | 16. Pillow | 22. Temperature Sensor |
| 5. Magna™ Jet | 11. Diverter Valve | 17. Filter Compartment | 23. Acquarella™ Waterfall Valve |
| 6. MagnaSage™ Jet | 12. Suction Screen | 18. Auxiliary Panel | |

CONTROLS AND EQUIPMENT

UTOPIA NIAGARA®

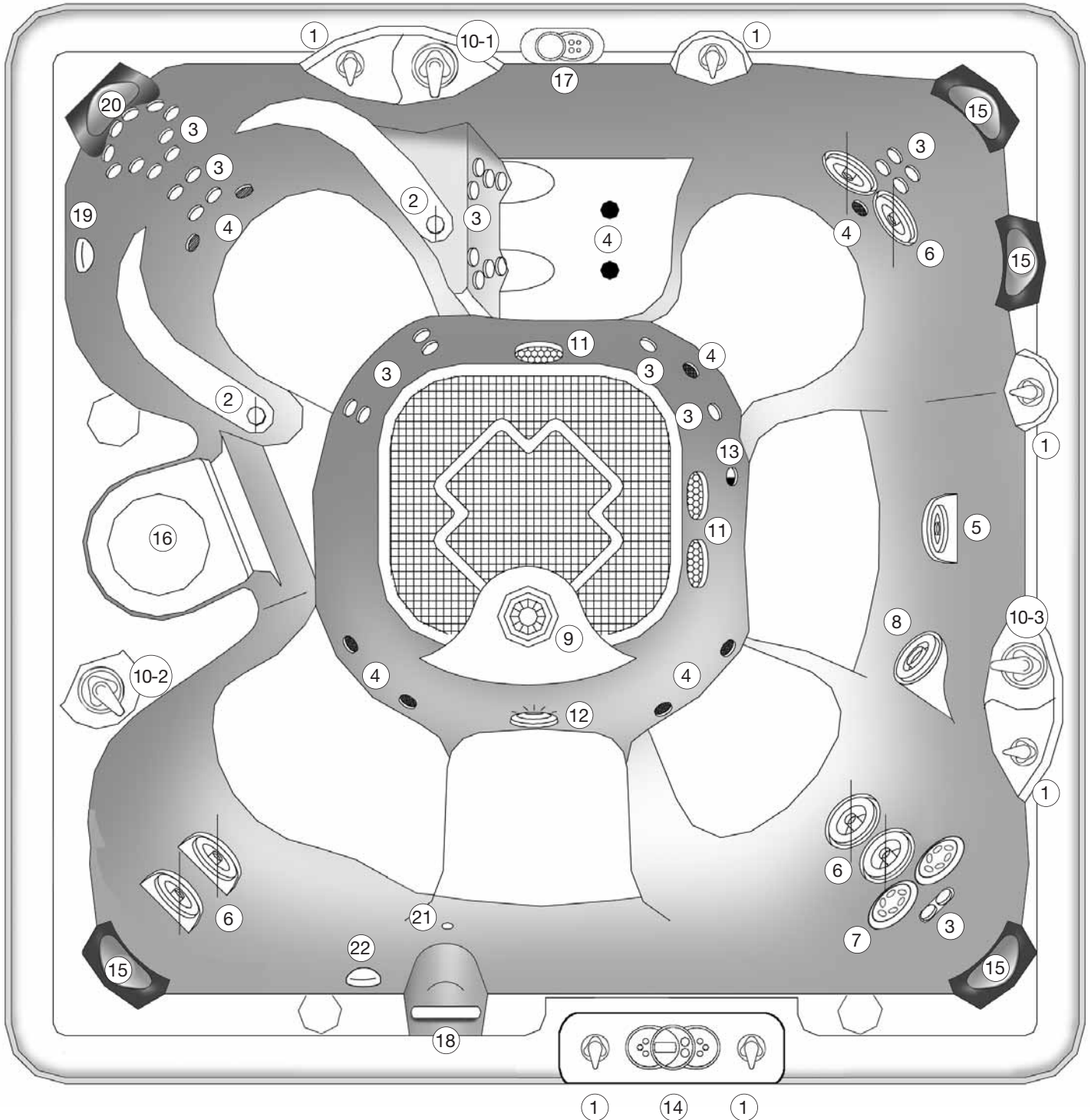

OVERHEAD VIEW

- | | | | | |
|-------------------------|--------------------|--------------------|---------------------------|-------------------------------|
| 1. Air Control | 6. VersaSage® Jet | 11. Suction Screen | 16. Filter Compartment | 20. Atlas Neck Jet Pillow |
| 2. Euro-Pulse® Jet | 7. OrbiSsage™ Jet | 12. Light | 17. Auxiliary Panel | 21. Temperature Sensor |
| 3. Euro Directional Jet | 8. Whirlpool Jet | 13. Ozone Jet | 18. Grab Rail | 22. Acquarella™ Waterfa Valve |
| 4. Air Jet | 9. Euphoria® Jet | 14. Control Panel | 19. Atlas® Neck Jet Valve | |
| 5. Magna™ Jet | 10. Diverter Valve | 15. Pillow | | |

CONTROLS AND EQUIPMENT

UTOPIA TAHITIAN®

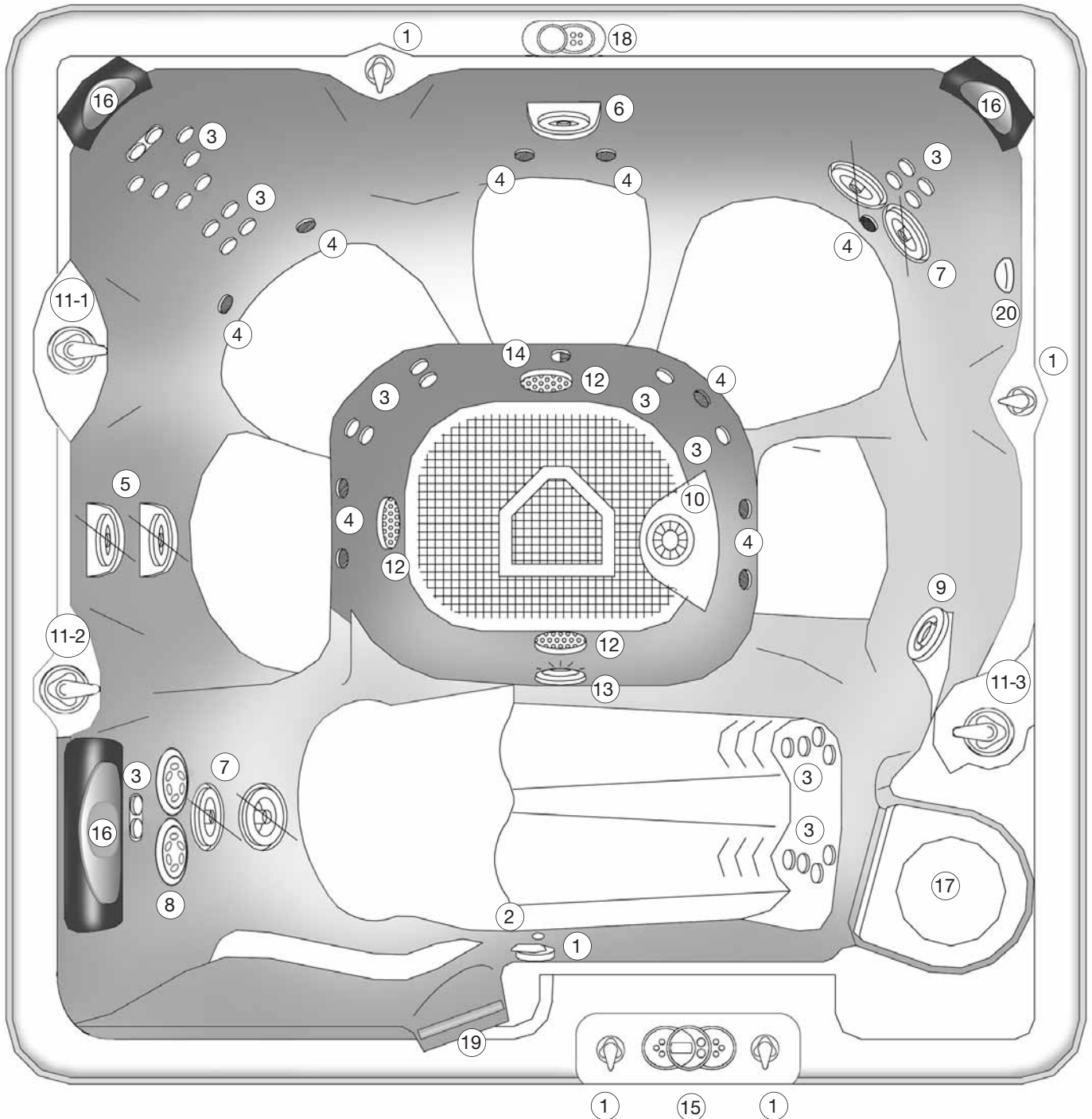

OVERHEAD VIEW

- | | | | |
|-------------------------|-------------------|--------------------|--------------------------------|
| 1. Air Control | 6. Magna™ Jet | 11. Diverter Valve | 16. Pillow |
| 2. Temperature Sensor | 7. VersaSage® Jet | 12. Suction Screen | 17. Filter Compartment |
| 3. Euro Directional Jet | 8. OrbiSsage™ Jet | 13. Light | 18. Auxiliary Panel |
| 4. Air Jet | 9. Whirlpool Jet | 14. Ozone Jet | 19. Grab Rail |
| 5. MagnaSsage™ Jet | 10. Euphoria® Jet | 15. Control Panel | 20. Aquarella™ Waterfall Valve |

CONTROLS AND EQUIPMENT

AQUATIC MELODIES® ELATION®

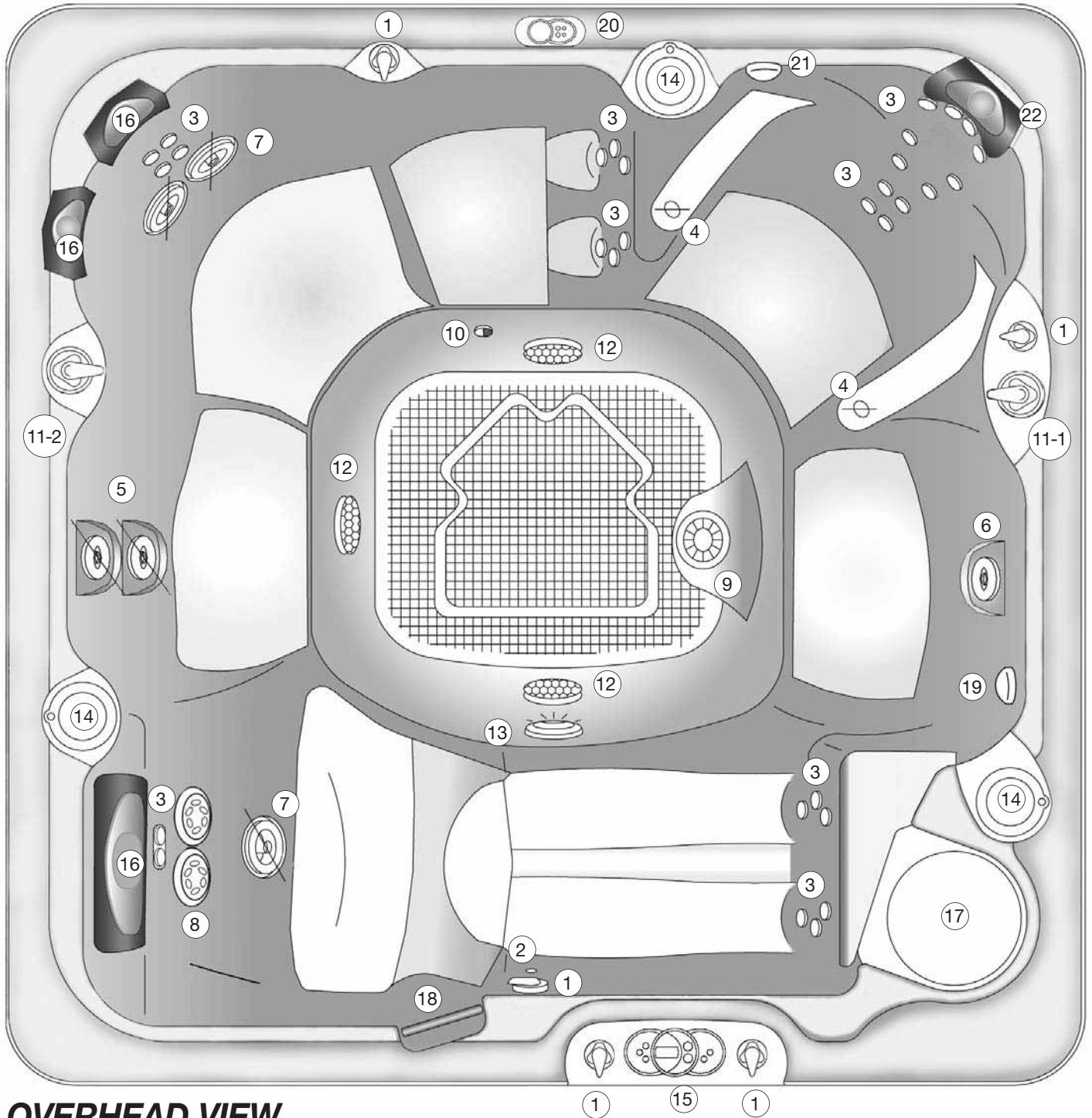

OVERHEAD VIEW

- | | | | | |
|-------------------------|-------------------|---------------------|---------------------------------|-----------------------------|
| 1. Air Control | 6. Magna™ Jet | 11. Diverter Valve | 16. Pillow | 20. Auxiliary Control Panel |
| 2. Temperature Sensor | 7. VersaSage® Jet | 12. Suction Screen | 17. Filter Compartment | 21. Atlas NeckJet Valve |
| 3. Euro Directional Jet | 8. OrbiSsage™ Jet | 13. Light | 18. Grab Rail | 22. Atlas NeckJet Pillow |
| 4. Euro-Pulse® Jet | 9. Euphoria® Jet | 14. Pop-up Speakers | 19. Acquarella™ Waterfall Valve | |
| 5. MagnaSsage™ Jet | 10. Ozone Jet | 15. Control Panel | | |

CONTROLS AND EQUIPMENT

AQUATIC MELODIES® ASPIRE™

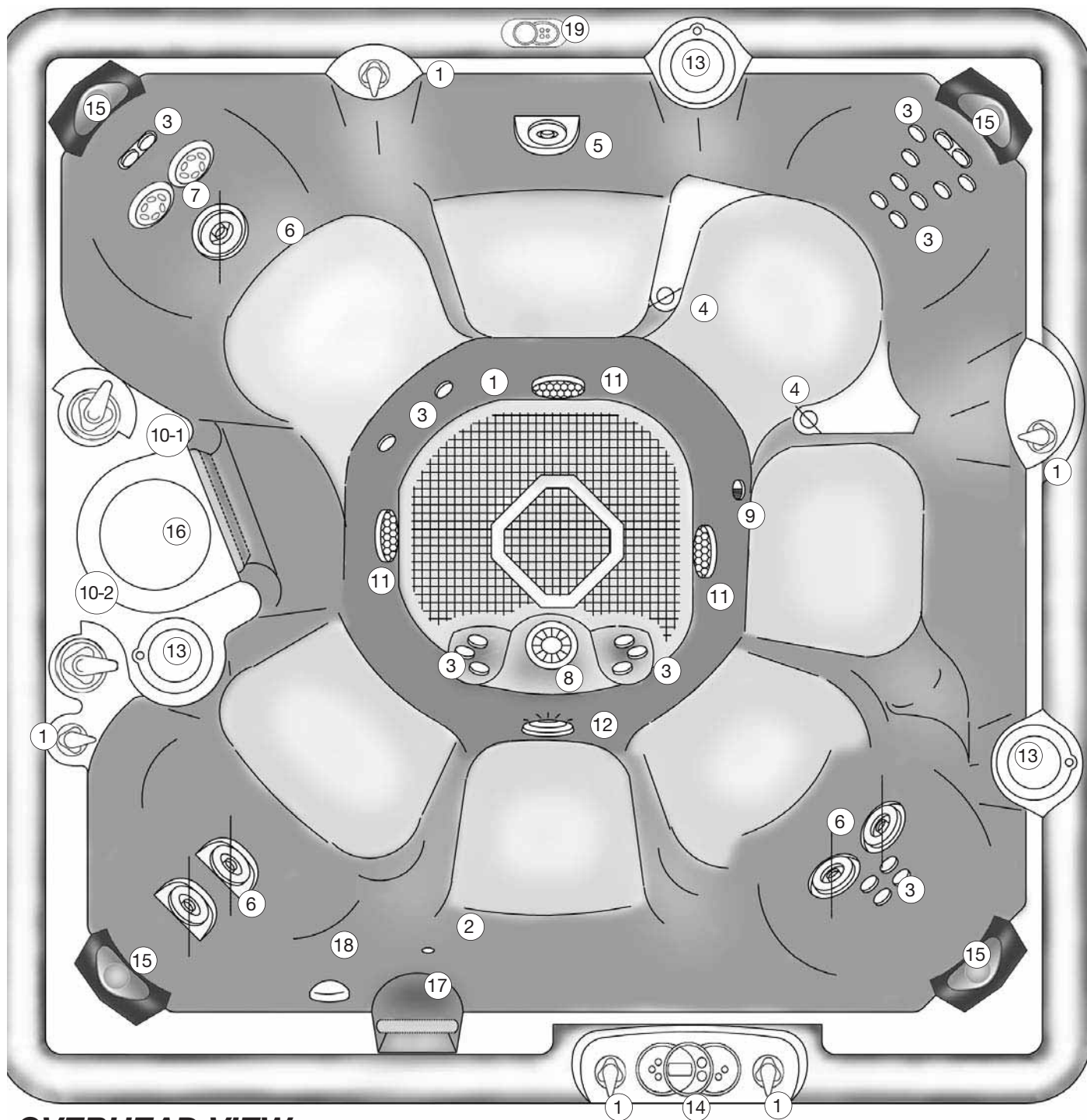

OVERHEAD VIEW

- | | | | | |
|-------------------------|--------------------|---------------------|---------------------------------|-----------------------------|
| 1. Air Control | 6. VersaSage® Jet | 11. Suction Screen | 16. Filter Compartment | 19. Auxiliary Control Panel |
| 2. Temperature Sensor | 7. OrbiSage™ Jet | 12. Light | 17. Grab Rail | |
| 3. Euro Directional Jet | 8. Euphoria® Jet | 13. Pop-up Speakers | 18. Acquarella™ Waterfall Valve | |
| 4. Euro-Pulse® Jet | 9. Ozone Jet | 14. Control Panel | | |
| 5. Magna™ Jet | 10. Diverter Valve | 15. Pillow | | |

ELECTRICAL INSTALLATION

ELECTRICAL REQUIREMENTS AND PRECAUTIONS

Your Caldera® spa has been carefully designed to give you maximum safety against electrical shock. Connecting the spa to an improperly wired circuit will negate many of the spa's safety features. Improper wiring may also cause electrocution, risk of fire, and other risks of injuries. Please read and follow the electrical installation requirements and instructions for your spa completely!

230 VOLT PERMANENTLY CONNECTED

CALDERA SPAS MUST BE WIRED IN ACCORDANCE WITH ALL APPLICABLE LOCAL ELECTRICAL CODES. ALL ELECTRICAL WORK SHOULD BE DONE BY AN EXPERIENCED LICENSED ELECTRICIAN. WE RECOMMEND THE USE OF APPROPRIATE ELECTRICAL CONDUIT, FITTINGS, AND WIRE FOR ALL CIRCUITS.

An electrical subpanel containing two GFCI breakers is included with each spa. We recommend that this subpanel be used to supply power and protect the spa.

This subpanel requires a 50 amp, single phase, 230 volt, four wire service (two line, one neutral, one ground). The ground wire must never be less than #10 AWG. Use NEC 250-122 (table) and local codes for more information. A minimum #10 AWG solid copper bond wire is also required.

Mount the subpanel in the vicinity of the spa, but not within five feet, in accordance with local codes.

INSTALLATION INSTRUCTIONS

1. To connect the electrical service, first remove the screws from the equipment compartment door (remove the fiber optic light cover and remove fiber optic cable from door), lower the door one inch and remove the door.
2. Locate the spa control box. Remove the screws on the front of the control box and remove the control box cover.
3. Route the electrical service from the subpanel into the spa equipment compartment.

NOTE: The subpanel must be placed in sight of the spa, no closer than five feet.

4. Connect wire to bottom of control box using a minimum of $\frac{3}{4}$ " liquid-tight, flex conduit fitting.

WIRING CONNECTIONS

1. Identify the TB-1 terminal block, located inside the control box at the lower left-hand corner.
2. Connect the #12 AWG, BLUE wire, from the subpanel 20 amp breaker, terminal L1 to TB-1, terminal 1
3. Connect the #12 AWG, RED wire, from the subpanel 20 amp breaker, terminal L2 to TB-1, terminal 3

NOTE: The WHITE neutral wire must be attached to the LOAD neutral on the 230 volt, 30 amp breaker (not to the neutral bus bar in the subpanel). The WHITE neutral wire coming from the breaker itself is already connected to the neutral bus bar.

4. Connect the #10 AWG, BLUE wire, from the subpanel 30 amp breaker, terminal L1 to TB-1, terminal 2
5. Connect the #10 AWG, RED wire, from the subpanel 30 amp breaker, terminal L2 to TB-1, terminal 4
6. Connect the #10 AWG, WHITE wire, from the subpanel 30 amp breaker, terminal N (load neutral) to TB-1, terminal 5
7. Connect the #10 AWG, GREEN wire, from the subpanel GROUND bar to TB-1, system ground terminal.
8. Using the pressure wire connector provided on the outside of the control box, bond the spa to all exposed metal equipment or fixtures, handrails, and the concrete pad (if applicable) per N.E.C. and local codes.
9. Replace the control box cover and securely tighten the fastening screws. Close and secure the equipment compartment door as follows:
 - Place top of door or panel directly below bartop against the frame of the spa.
 - Push bottom of door or panel against the spa frame.
 - Slide door or panel upward (pushing in on center of door) until screw holes line up.
 - Slightly pull on door or panel, if door remains against the spa then replace the screws.
 - If the door does not lock into position, repeat the previous steps.

⚠ WARNING: FILL THE SPA WITH WATER BEFORE TURNING ON THE POWER! (See STARTUP AND REFILL PROCEDURES).

Once your spa has been filled with water, turn it on and test all of the circuit breakers.

NOTE: If both breakers immediately trip, verify that the #10 AWG WHITE neutral wire is connected from TB-1 terminal 5 to the N (load neutral) terminal of the 30 amp subpanel breaker. Each breaker should be tested prior to each use. Here's how:

1. Push the "TEST" button on each GFCI breaker, and observe it click OFF.
2. Wait 30 seconds, then push the breaker switch to the OFF (down) position (to ensure that it has completely disengaged), then push the breaker switch to the ON (up) position. If you don't wait 30 seconds, the spa's control panel may flash four lines on and off – try again.

If any of the GFCI breakers fails to operate in this manner, your spa may have an electrical malfunction, and you may be at risk of electrical shock. Turn off all circuits and do not use the spa until the problem has been corrected by an authorized service agent.

SERVICE NOTE: All Caldera spas have diagnostic functions that are displayed on the control panel. Four flashing lines are visible on the control panel if the heater high limit thermostat has tripped. If the four flashing lines are visible, follow the instructions in the troubleshooting section to identify and correct the cause. The four flashing lines will stop flashing once the problem has been corrected.

ELECTRICAL INSTALLATION

⚠ **WARNING:** Removing or bypassing any GFCI breaker will result in an unsafe spa and will void the spa's warranty.

IMPORTANT: Should you ever find the need to move or relocate your Caldera® spa, it is essential that you understand and apply these installation requirements. Your Caldera spa has been carefully engineered to provide maximum safety against electric shock. Remember, connecting the spa to an improperly wired circuit will negate many of its safety features.

NOTE: Long wiring runs may require larger-gauge wire than stated.

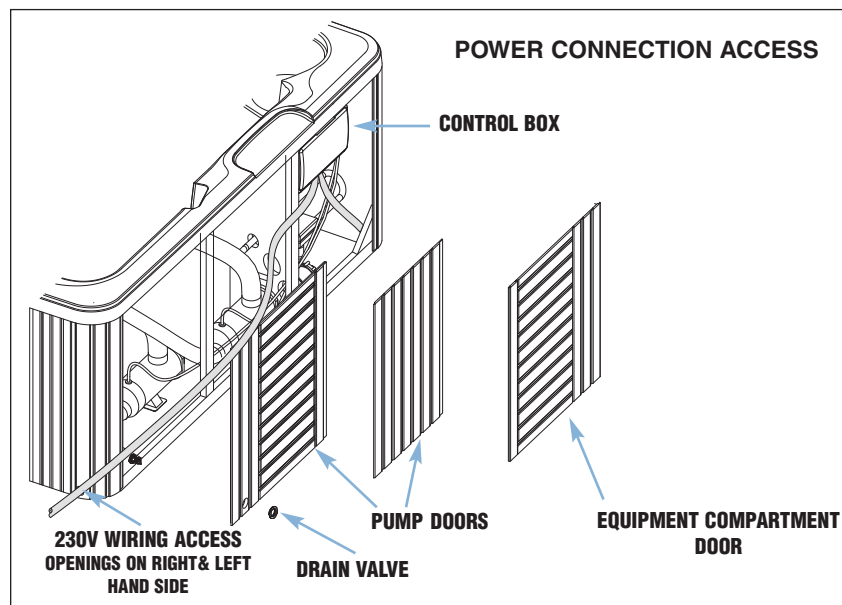
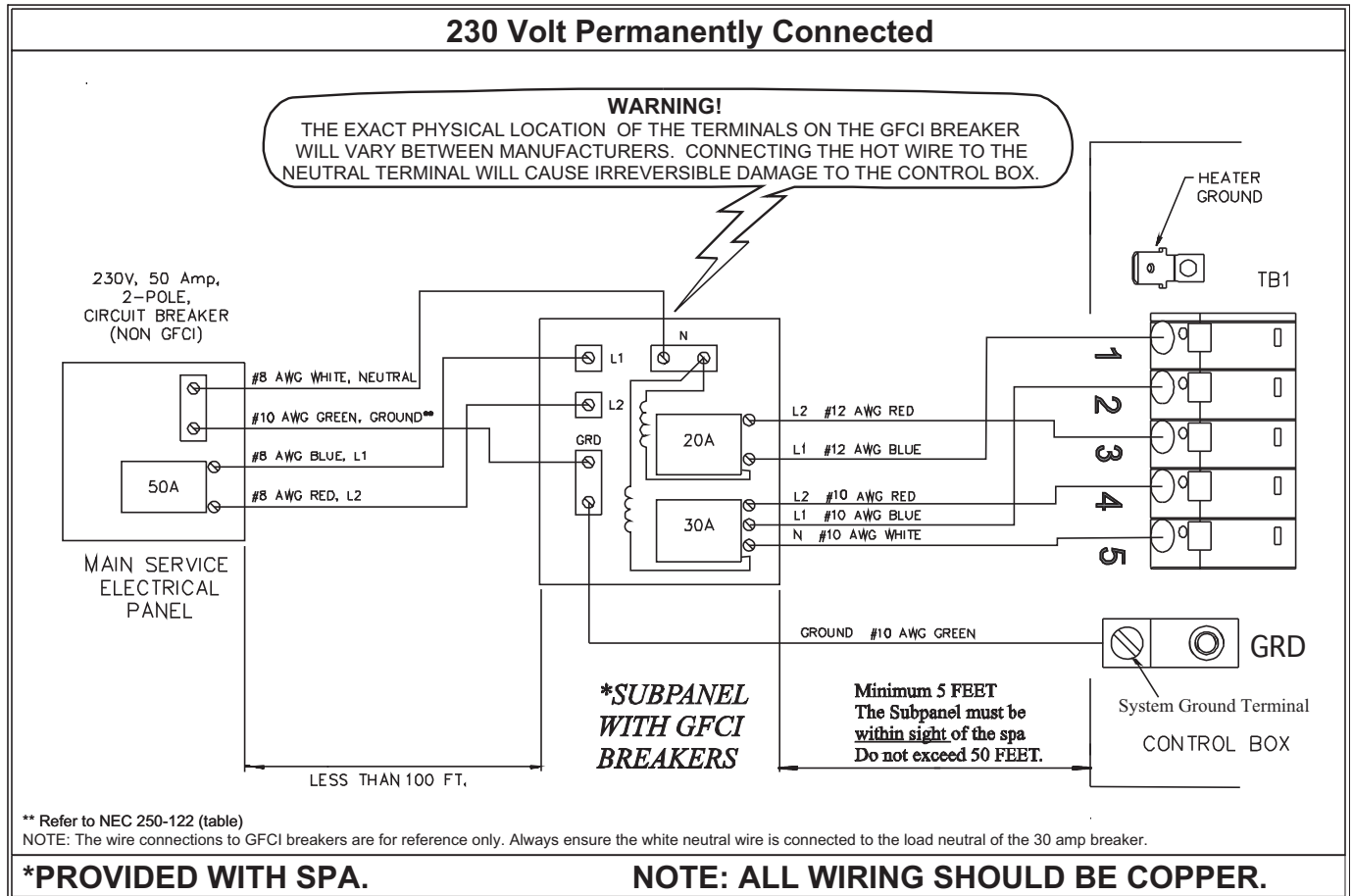

START-UP AND REFILL PROCEDURES

Your Caldera® spa has been thoroughly tested during the manufacturing process to ensure reliability and long-term customer satisfaction. A small amount of water may have remained in the plumbing after testing and, as a result, may have spotted the spa shell or the spa siding prior to delivery. Before filling the spa, clear all debris from the spa and wipe the spa shell clean with a soft rag.

THE FOLLOWING INSTRUCTIONS MUST BE READ AND FOLLOWED EXACTLY TO ENSURE A SUCCESSFUL START-UP OR REFILL.

CAUTIONS

- Do not fill the spa with hot water, as tripping of the high-limit thermostat may result.
 - DO NOT CONNECT POWER TO AN EMPTY SPA. Power to the spa automatically activates critical components within the spa, such as controls, heater, circulation pump and other systems. If power is supplied to these components prior to the spa being filled, the components will be damaged, and this may result in a non-warranty component failure.
 - Do not use your spa after filling until all of the steps listed below are completed.
 - Do not add chlorine if treating your spa with polyhexamethylene biguanide (Biguanide, PHMB, eg. BaquaSpa™) sanitizer.
 - Before filling your spa for the first time, remove the equipment compartment door and pump door (remove drain valve collar from pump door first) and check to ensure that the unions on either side of the pump are hand-tight.
1. Close all drains and fill the spa with water by removing the filter lid, skimmer basket, weir and filter (see Filter Lid Removal instructions). Then insert the end of a garden hose into the filter canister and begin filling the spa. The water level of your Caldera spa should be approximately one inch above the highest jet in the spa excluding the four above-water-line neck jets in the EcstaSeat™ (Geneva™, Niagara® and Elation® only). Reinstall the skimmer basket, weir, filter and filter lid once the spa is filled.
IMPORTANT: Watkins® Manufacturing Corporation does not recommend that the spa be filled with “softened” water, as this may damage the spa’s equipment.
 2. **AFTER** the spa has been filled with water and the equipment compartment door is secured, power must be applied to the spa.
 - Activate power to the subpanel from the main house panel first.
 - Open the door of the electrical subpanel and reset the GFCI breakers. Close and secure the subpanel door.
 3. The jet pumps, heating system and all internal plumbing will achieve a partial prime as the spa is filled. Five minutes after power is applied to the spa, the air blower will activate for one minute (Utopia series only), followed by Jet Pump 2 on high speed for one minute, followed by Jet Pump 1 for eight minutes (nine minutes for Aquatic Melodies series). Once the jet system is fully operational (as indicated by strong, non-surging jets), priming of the spa is complete. If you do not feel a steady stream of water from your jets, refer to the instructions for priming the pump in the SPA TROUBLESHOOTING section in the back of this manual.
 4. Adjust Total Alkalinity (TA) to 125 ppm, Calcium Hardness (CH) to 150 ppm, then spa water pH to between 7.4 and 7.6. These procedures are listed in the “Water Quality and Maintenance” section.
IMPORTANT: Add spa water chemicals directly into or in front of the filter compartment (do not remove filter lid) while the jet pump is on and run for at least ten minutes (depress “CLEAN” button on the control panel).
OPERATION NOTE: Adjusting the Total Alkalinity as the first step is important, as out-of-balance TA will affect your ability to adjust the pH correctly and will prevent the sanitizer from operating effectively.
 5. Superchlorinate the spa water by adding 1-1/2 teaspoons of chlorine (sodium dichlor) per 250 gallons of spa water. When adding chlorine, the jet pump should be running, and remain on to circulate the spa water for a ten-minute period (use clean cycle). Make sure all the diverter valves are set to the middle position.
 6. Set the temperature control to the desired temperature (between 100°F and 104°F), then place the vinyl cover on the spa and allow the water temperature to stabilize (approximately 24 hours). Make sure you secure the cover in place using the cover locks. Periodically check the spa water temperature. When the water temperature climbs above 90°F, proceed to the next step.
 7. Press “CLEAN” button on the main control panel, this will run jet pump one for ten minutes to circulate the spa water. Make sure all the diverter valves are set to the middle position. Once the jets shut off, test the spa water for Free Available Chlorine (FAC) residual. If the residual is between 3 and 5 ppm, go on to the next step. If the residual is less than 3 ppm, superchlorinate the spa water by adding 1-1/2 teaspoons of chlorine (sodium dichlor) per 250 gallons of spa water, while the jet pump is running. Run the jet pump to circulate the spa water for an additional ten-minute period.
 8. Recheck the Total Alkalinity (TA) at 125 ppm, Calcium Hardness (CH) at 150 ppm, then spa water pH at between 7.4 and 7.6.
OPERATION NOTE: Make sure you adjust your Total Alkalinity first, as an out-of-balance condition will affect your ability to adjust the pH correctly, and will prevent the sanitizer from operating effectively. **The spa is ready for use when the spa water has circulated and the chlorine level remains between 3 ppm and 5 ppm.**
 9. The spa temperature is pre-programmed to reach 102°F, and will normally do so within 18 to 24 hours. You may raise the water temperature by pressing the “TEMP (▲)” button on the control panel once to display the temperature, then pressing it again within five seconds to raise the temperature, or lower it by pressing “TEMP (▼)” button once to display the temperature, then pressing it again within five seconds to lower the temperature. After a few hours, the water temperature will remain within 1-1/2 degrees of your selected temperature.
OPERATION NOTE: For proper water circulation during the automatic clean cycle the following steps should be performed.
 - Place the diverters in the middle (split flow) position.
 - Place air control levers in OFF position by rotating clockwise.

CUSTOMIZING YOUR MASSAGE

Your Caldera® spa offers numerous ways for you to customize your massage experience. Experimentation is the best way to find what feels best to you. Try sitting in different seats, adjusting the diverter valves, air controls, and jet nozzles and turning each pump on or off.

DIVERTER VALVES

The diverter valves on your spa allow you to direct the flow of water from the pumps to various combinations of jets. The functions of these diverter valves can best be learned by experimentation as follows:

1. Set all air controls to the "ON" position by rotating counterclockwise.
2. Turn on both pumps.
3. Turn the handle on each diverter valve and see which groups of jets are affected. (Note that you can adjust the diverter valves to any position between the two possible extremes to achieve the jet pressure that feels best to you.)

IMPORTANT: Your spa is not designed to provide full power to all jets when the diverter valves are in the "mid" position. However, with the diverter valve in this position, you may increase the power to selected jets by rotating the face of the Magna™ and MagnaSsage™ jets to close the ones that are not in use.

TIP: Turn both pumps on and place the diverter valves to the "Mid-Position". Then experiment with each of the air controls to see their effect.

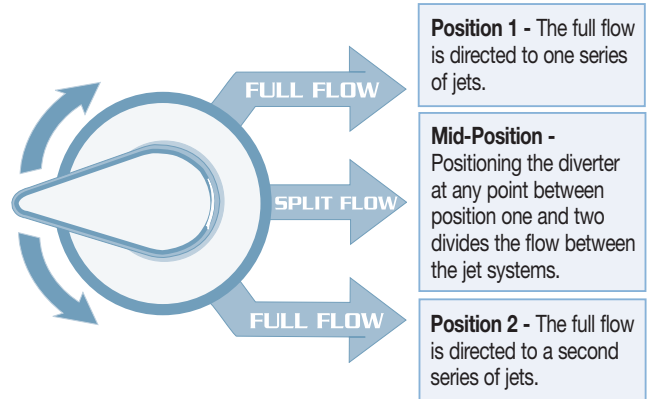

ACQUARELLA™ WATERFALL VALVE

Your spa is equipped with the Acquarella waterfall feature. It is activated by turning on jet pump 2 (either low or high speed). The flow is regulated by turning the Acquarella waterfall valve on the inside wall of the spa.

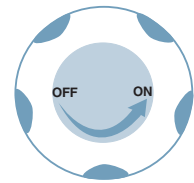

ATLAS® NECK JET VALVE

The Geneva™, Niagara®, and Elation® spas are equipped with 4 directional neck jets located in the EcstaSeat™. The flow of the neck jets is regulated by turning the Atlas NeckJet valve on the inside wall of the spa.

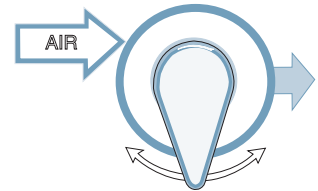

AIR CONTROLS

Each jet system has its own air control. These allow you to change the power of the jets by regulating the amount of air that is mixed with the water coming out of the jets.

HYDRO JETS

Magna Jets - These jets allow you to redirect the jet stream by changing the position of the nozzle.

MagnaSsage Jets - These jets provide a rotating massage pattern.

The nozzles in the Magna jets and the MagnaSsage jets are interchangeable. To remove a MagnaSsage rotating nozzle, simply grasp it and pull straight out. To install, align and push straight in, the nozzle will snap into place. To remove, or install a standard Magna jet nozzle, rotate the tabs on either side of the nozzle. Additional MagnaSsage rotating nozzles and dual-port nozzles are available from your Caldera dealer.

Both the Magna and MagnaSsage jets allow you to regulate the force of the massage. Rotate the fascia ring clockwise to reduce the force, or counter-clockwise to increase the force. Notice that turning off the flow to some jets increases the flow to the other jets. To avoid damage to your spa's plumbing and components, do not turn off more than half of these jets at the same time.

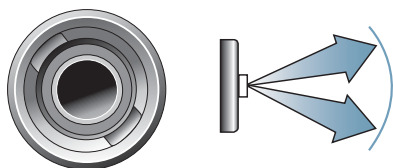
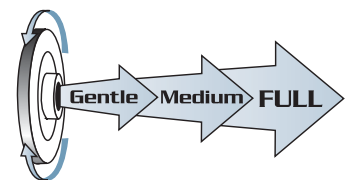

Magna Jet

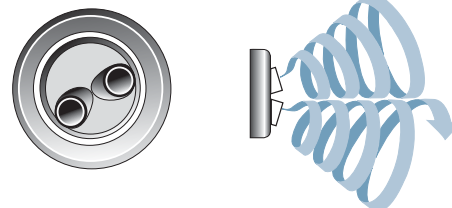

MagnaSsage Jet

CUSTOMIZING YOUR MASSAGE

Euro Directional and Euro-Pulse Jets - The Euro Directional jets, with eyeball nozzles, deliver a direct, more focused massage. The Euro-Pulse jets feature a special insert that creates a soft, pulsating, rotary massage. The Euro-Pulse jet cap assemblies may be removed if you want a more powerful, direct massage in the wrist locations. To do this, rotate counter clockwise and pull off. If you desire, you may install a Euro-Pulse jet cap removed from one jet onto a standard Euro Directional jet by simply snapping the assembly into place. You may purchase additional roto jet assemblies from your Caldera® dealer.

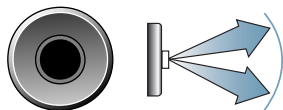

Euro Directional Jet



Euro-Pulse® Jet

VersaSsage Jets - These jets may be adjusted to provide either a stationary, direct stream, or, by positioning the nozzle to one side, a variety of rotating massage patterns. Also, the speed of the rotation can be changed by rotating the jet faceplate from a full stream, to shutting the jet completely off. For cleaning or replacement instructions see VersaSsage & OrbiSsage Jets Maintenance section. To avoid damage to your spa's plumbing and components, do not turn off more than half of these jets at the same time.

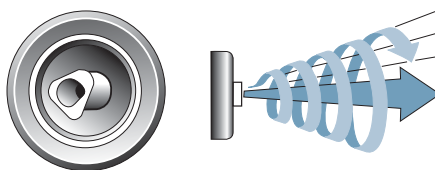

VersaSsage® Jet

OrbiSsage Jets - This jet provides a unique, pulsating massage. The flow is adjustable in that it can be turned completely off or on (by rotating the jet faceplate). It is also interchangeable with the VersaSsage jet. For cleaning or replacement instructions see VersaSsage & OrbiSsage Jets Maintenance section.

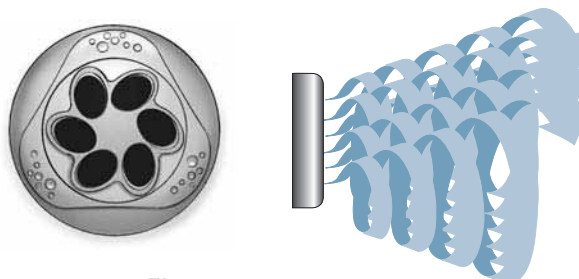

OrbiSsage™ Jet

AIR JETS

The air jet system consists of a 1 HP air pump and 10 air jets found on Geneva™, Niagara®, and Tahitian® spas. At the beginning of the automatic operation cycle, the air jets will operate for one minute to clean out the air channel. The air jets deliver air bubbles to provide subtle pulsation for a gentle, soft-tissue massage.

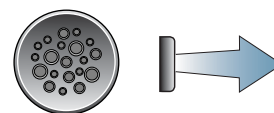

Air Jet

JET MENU

UTOPIA GENEVA™

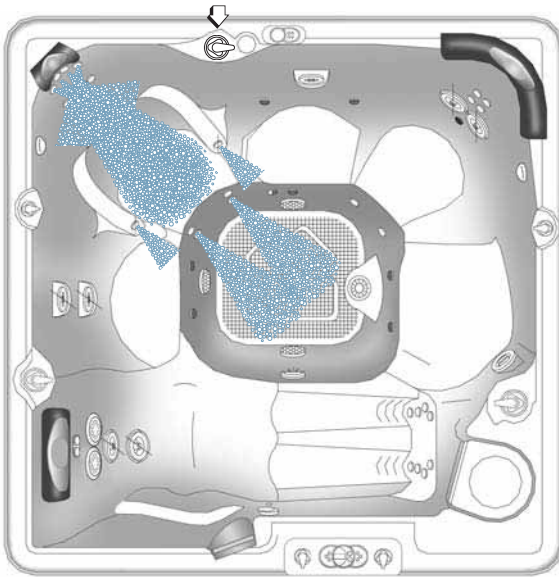

Jet Pump 1-Jet System 1

Located in EcstaSeat™ – back left:

- 2 Euro-Pulse® jets
- 14 Euro Directional jets
- 4 directional neck jets

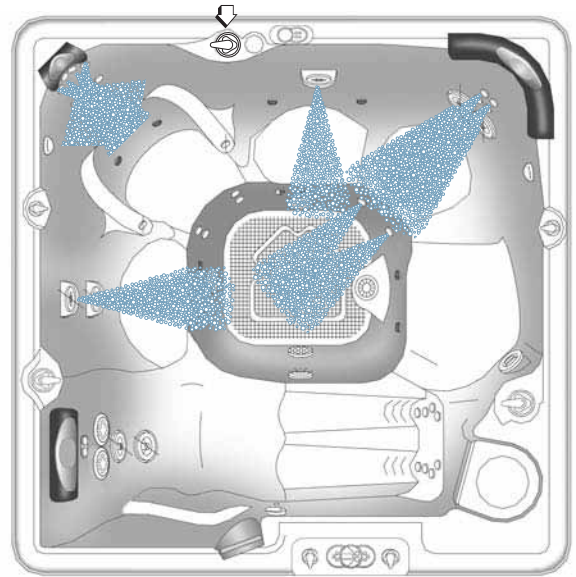

Jet Pump 1-Jet System 2

- 2 MagnaSsage™ jets on left wall
- 1 Magna™ jet on back wall
- 4 directional neck jets

Located in LumbarSsage® seat – back right:

- 6 Euro Directional jets
- 2 VersaSsage® jets

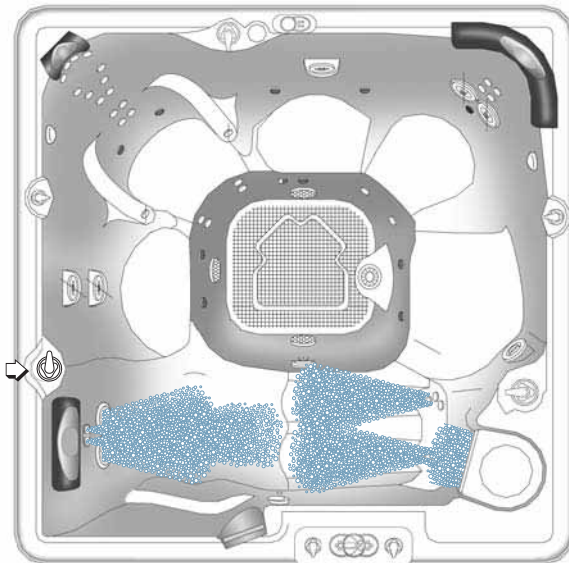

Jet Pump 2-Jet System 1

- Acquarella™ Waterfall

Located in Ultra Massage lounge – front:

- 8 Sole Soothers®
- 2 Euro Directional jets
- 2 VersaSsage jets
- 2 OrbiSsage™ jets

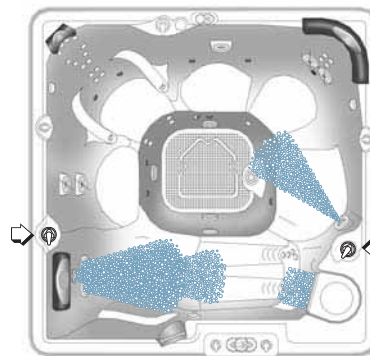

Jet Pump 2-Jet System 2

Located in Ultra Massage seat – front right:

- 2 Euro Directional jets
 - 2 VersaSsage jets
 - 2 OrbiSsage jets
- (Activates right side diverter)

Right Side Jet System 1:

- 1 Whirlpool jet on right wall
- Acquarella Waterfall

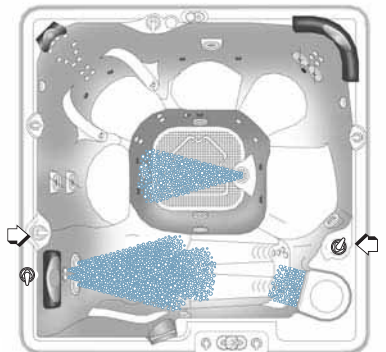

Jet Pump 2-Jet System 2

Located in Ultra Massage seat – front right:

- 2 Euro Directional jets
 - 2 VersaSsage jets
 - 2 OrbiSsage jets
- (Activates right side diverter)

Right Side Jet System 2:

- 1 Euphoria® jet in footwell
- Acquarella Waterfall

Combination Jet System

Jet Pump 1 diverter in mid position activates both Jet Pump 1 Systems 1 and 2.
 Jet Pump 2 diverter in mid position activates both Jet Pump 2 Systems 1 and 2.
 Right Side diverter in mid position activates Right Side Systems 1 and 2.

JET MENU

UTOPIA NIAGARA®

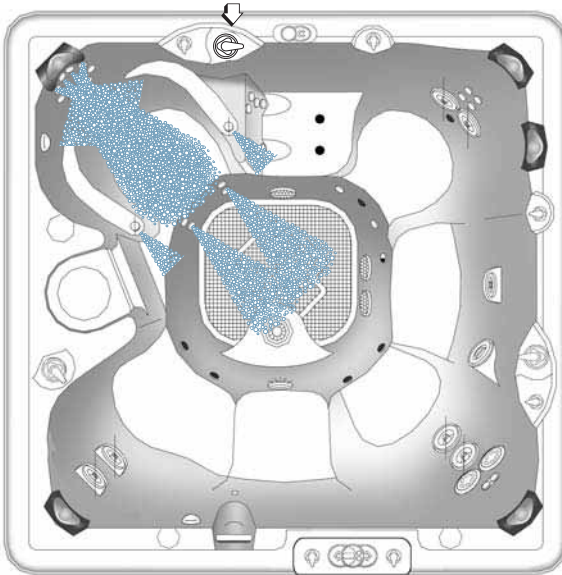

Jet Pump 1-Jet System 1

Located in EcstaSeat™ – back left:

- 2 Euro-Pulse® jets
- 14 Euro Directional jets
- 4 directional neck jets

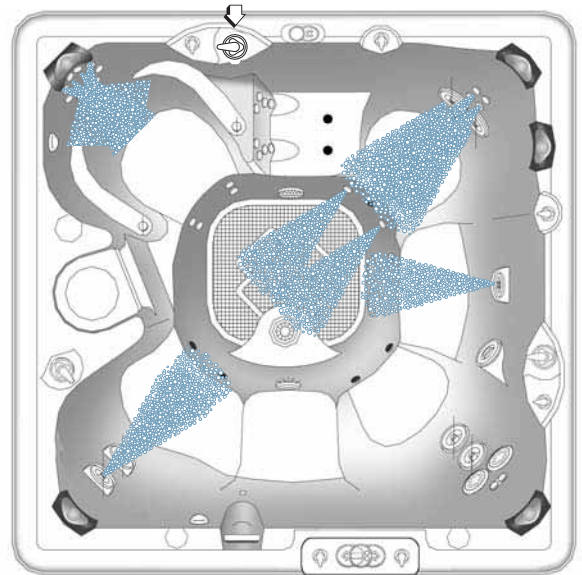

Jet Pump 1-Jet System 2

- 1 Magna™ jet on right wall
- 2 VersaSsage® jets on front left wall
- 4 directional neck jets

Located in LumbarSsage® seat – back right:

- 6 Euro Directional jets
- 2 Versa jets

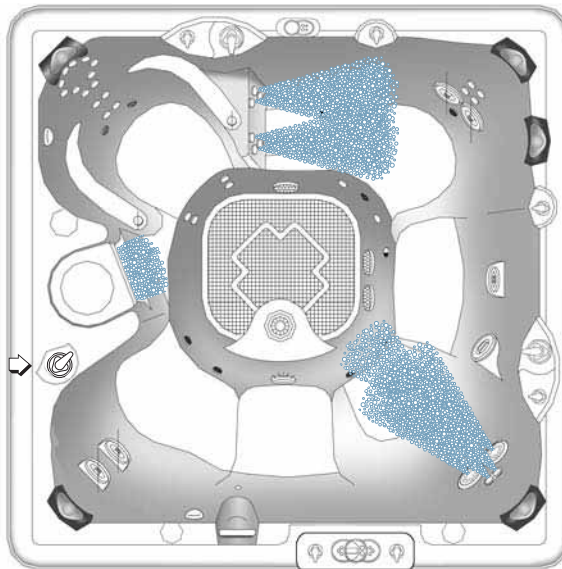

Jet Pump 2-Jet System 1

- 8 Sole Soothers® in back center
- Acquarella™ Waterfall

Located in Ultra Massage seat – front right:

- 2 Euro Directional jets
- 2 VersaSsage jets
- 2 OrbiSsage™ jets

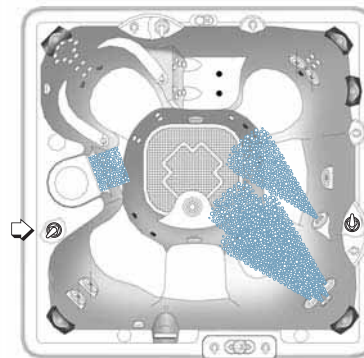

Jet Pump 2-Jet System 2

Located in Ultra Massage seat – front right:

- 2 Euro Directional jets
 - 2 VersaSsage jets
 - 2 OrbiSsage jets
- (Activates right side diverter)

Right Side Jet System 1:

- 1 Whirlpool jet on right wall
- Acquarella Waterfall

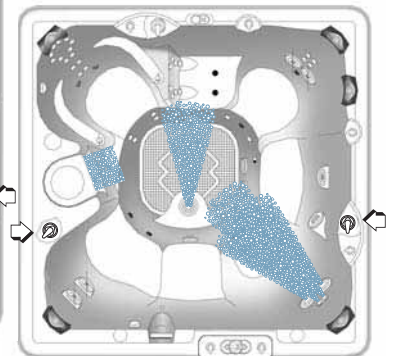

Jet Pump 2-Jet System 2

Located in Ultra Massage seat – front right:

- 2 Euro Directional jets
 - 2 VersaSsage jets
 - 2 OrbiSsage jets
- (Activates right side diverter)

Right Side Jet System 2:

- 1 Euphoria® jet in footwell
- Acquarella Waterfall

Combination Jet System

Jet Pump 1 diverter in mid position activates both Jet Pump 1 Systems 1 and 2.
 Jet Pump 2 diverter in mid position activates both Jet Pump 2 Systems 1 and 2.
 Right Side diverter in mid position activates Right Side Systems 1 and 2.

JET MENU

UTOPIA TAHITIAN®

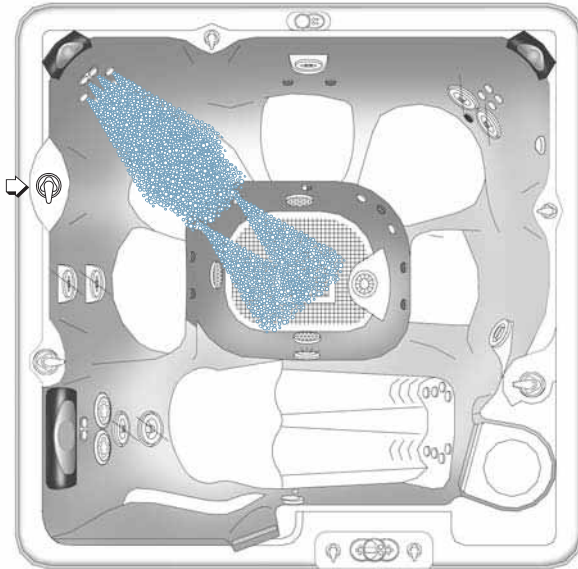

Jet Pump 1-Jet System 1

- Located in EcstaSeat™ – back left:
- 16 Euro Directional jets

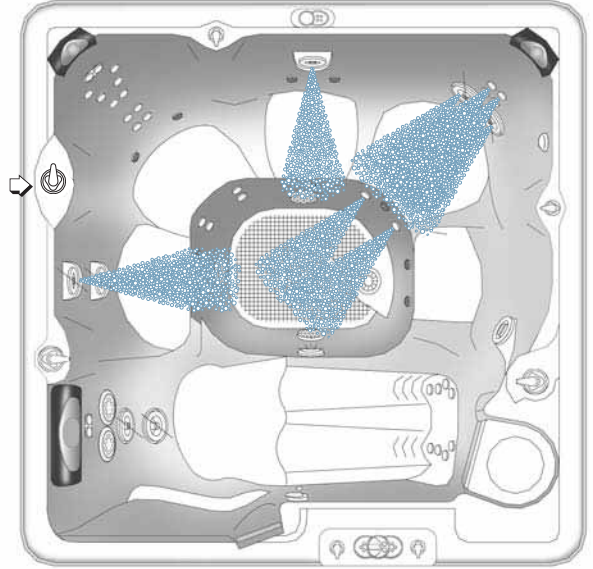

Jet Pump 1-Jet System 2

- 2 MagnaSsage™ jet on left wall
- 1 Magna™ jet on back wall
- Located in LumbarSsage® seat – back right:
- 6 Euro Directional jets
- 2 VersaSsage® jets

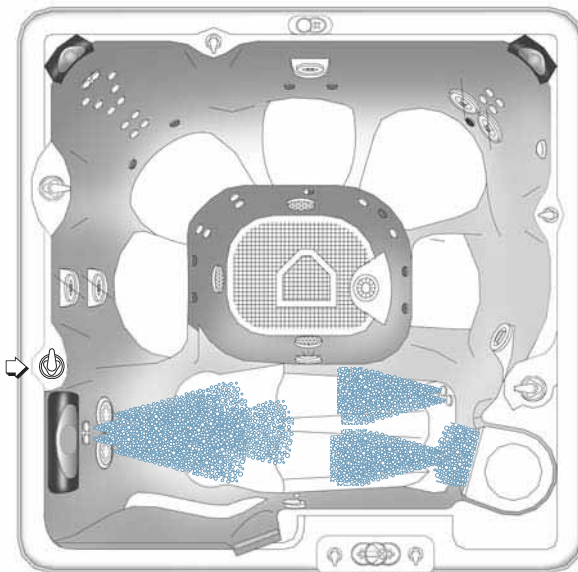

Jet Pump 2-Jet System 1

- Acquarella™ Waterfall
- Located in Ultra Massage seat – front:
- 8 Sole Soothers®
- 2 Euro Directional jets
- 2 VersaSsage jets
- 2 OrbiSsage™ jets

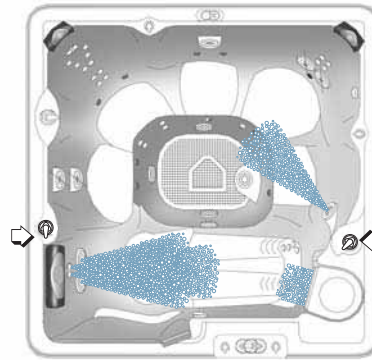

Jet Pump 2-Jet System 2

- Located in Ultra Massage seat – front right:
- 2 Euro Directional jets
- 2 VersaSsage jets
- 2 OrbiSsage jets
- (Activates right side diverter)

Right Side Jet System 1:

- 1 Whirlpool jet on right wall
- Acquarella Waterfall

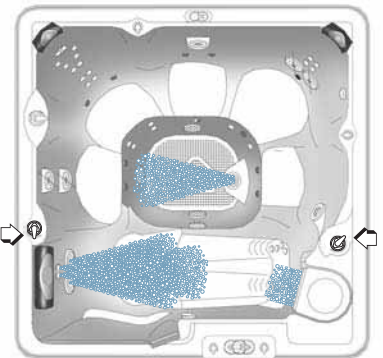

Jet Pump 2-Jet System 2

- Located in Ultra Massage seat – front right:
- 2 Euro Directional jets
- 2 VersaSsage jets
- 2 OrbiSsage jets
- (Activates right side diverter)

Right Side Jet System 2:

- 1 Euphoria® jet in footwell
- Acquarella Waterfall

Combination Jet System

Jet Pump 1 diverter in mid position activates both Jet Pump 1 Systems 1 and 2.
 Jet Pump 2 diverter in mid position activates both Jet Pump 2 Systems 1 and 2.
 Right Side diverter in mid position activates Right Side Systems 1 and 2.

JET MENU

AQUATIC MELODIES™ ELATION®

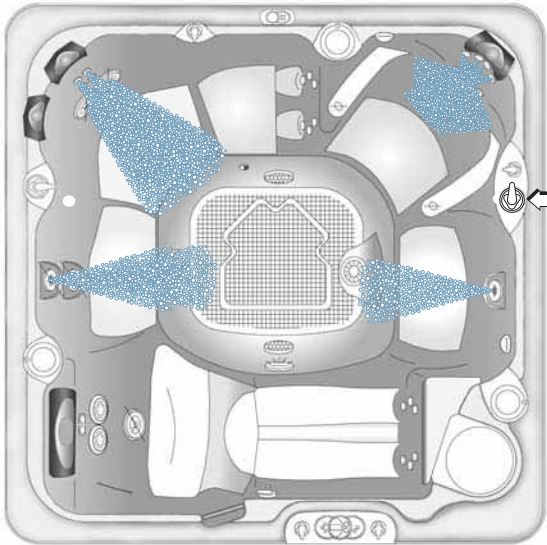

Jet Pump 1-Jet System 1

- 1 Magna™ jet on right wall
- 2 MagnaSsage™ jets on left wall
- 4 Directional Neck jets

Located in LumbarSsage® seat – back left:

- 4 Euro Directional jets
- 2 VersaSsage® jets

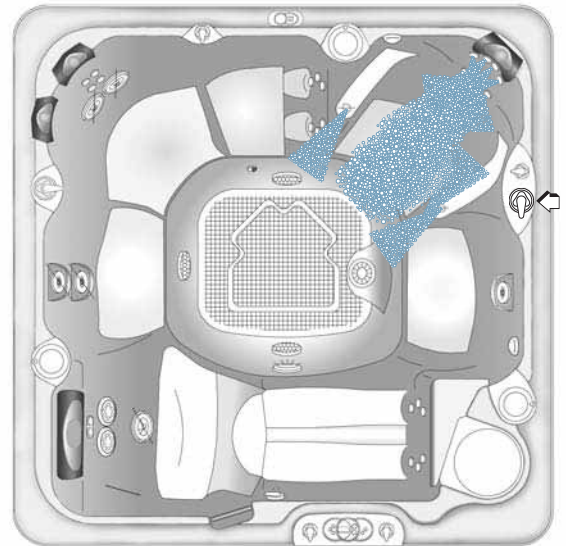

Jet Pump 1-Jet System 2

Located in EcstaSeat™ – back right:

- 2 Euro-Pulse® jets
- 8 Euro Directional jets
- 4 Directional Neck jets

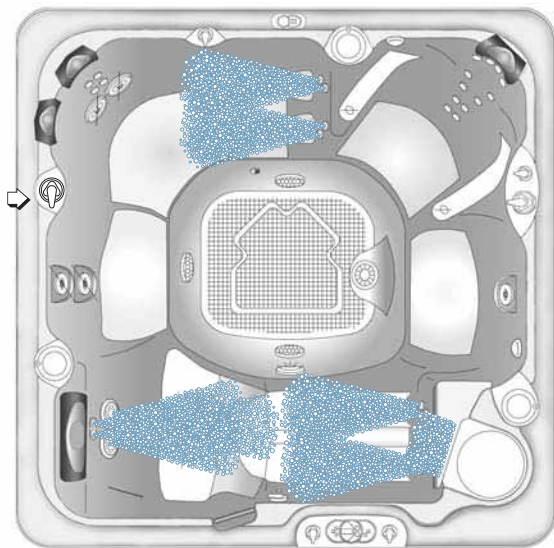

Jet Pump 2-Jet System 1

- Acquarella™ Waterfall
 - 6 Sole Soothers® in back center
- Located in Ultra Massage seat:

- 2 Euro Directional jets
- 1 VersaSsage jets
- 2 OrbiSsage™ jets
- 6 Sole Soothers

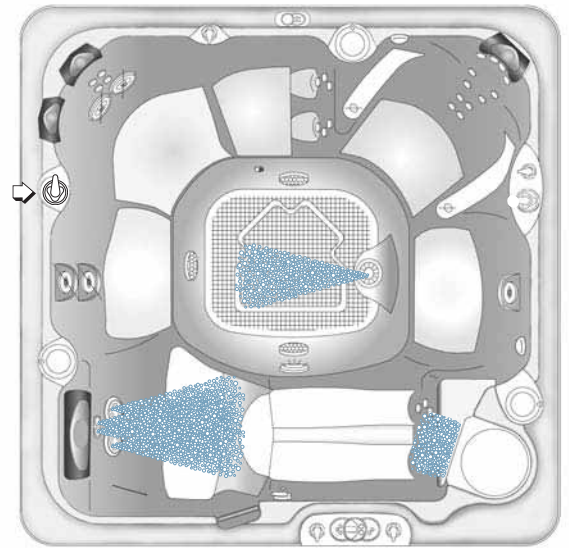

Jet Pump 2-Jet System 2

- Acquarella Waterfall

- 1 Euphoria® jet in footwell
- Located in Ultra Massage seat:

- 2 Euro Directional jets
- 1 VersaSsage jets
- 2 OrbiSsage jets

Combination Jet System

Jet Pump 1 diverter in mid position activates both Jet Pump 1 Systems 1 and 2.
 Jet Pump 2 diverter in mid position activates both Jet Pump 2 Systems 1 and 2.

JET MENU

AQUATIC MELODIES® ASPIRE™

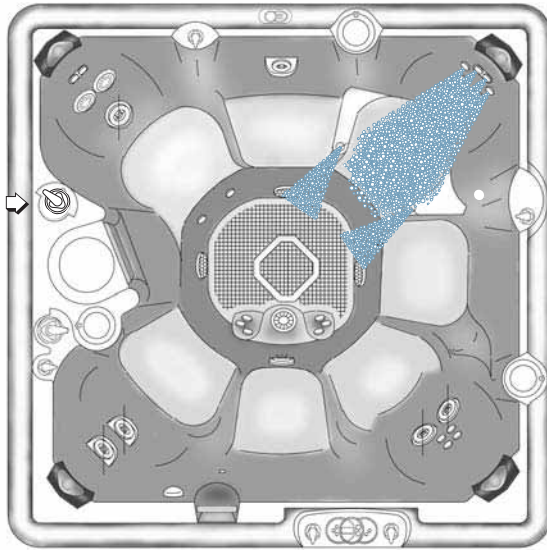

Jet Pump 1-Jet System 1

Located in EcstaSeat™ – back right:

- 2 Euro-Pulse® jets
- 10 Euro Directional jets

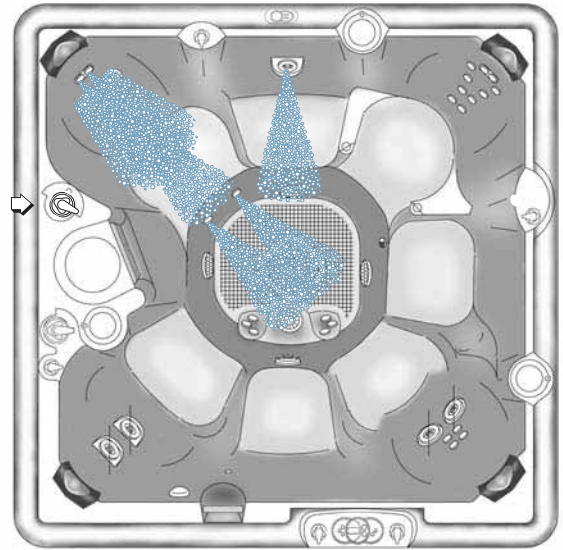

Jet Pump 1-Jet System 2

- 1 Magna™ jet on back wall

Located in Ultra Massage® Seat: – back left:

- 1 VersaSage® jets
- 2 OrbiSage™ jets
- 4 Euro Directional jets

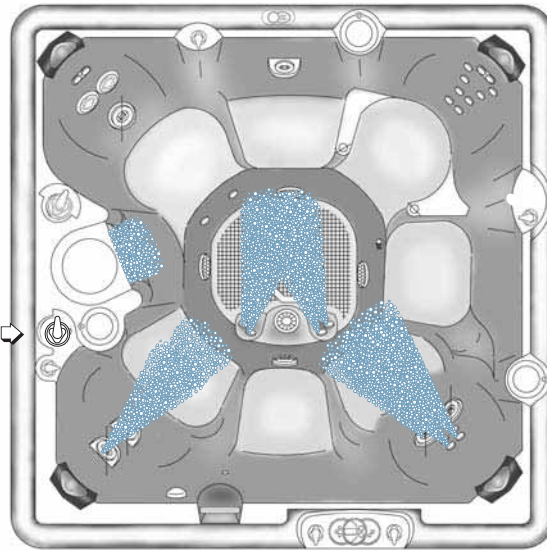

Jet Pump 2-Jet System 1

- Acquarella™ Waterfall
 - 6 Sole Soothers® in footwell
 - 2 VersaSage jets on front left wall
- Located in LumbarSage® seat – front right:
- 4 Euro Directional jets
 - 2 VersaSage jets

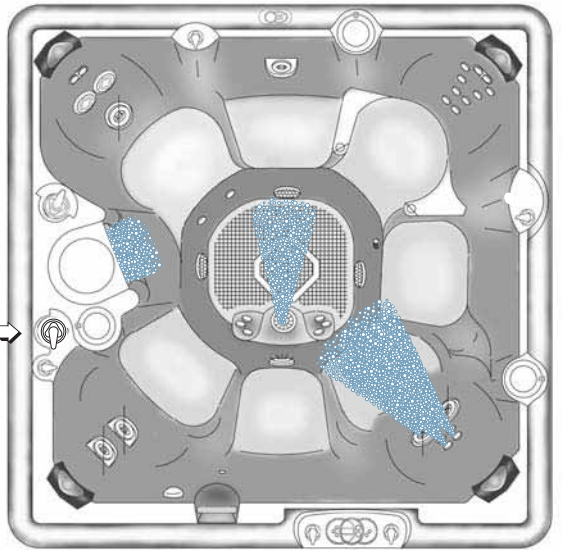

Jet Pump 2-Jet System 2

- Acquarella Waterfall
- 1 Euphoria® jet in footwell

Located in LumbarSage seat – front right:

- 4 Euro Directional jets
- 2 VersaSage jets

Combination Jet System

Jet Pump 1 diverter in mid position activates both Jet Pump 1 Systems 1 and 2.
Jet Pump 2 diverter in mid position activates both Jet Pump 2 Systems 1 and 2.

OPERATING INSTRUCTIONS

CONTROL PANELS

Main Control Panel

TEMP (up) button
Increases the temperature

SET button
Used to initiate advanced panel features.

TEMP (down) button
Decreases the temperature

JETS 1 button
Controls jet pump 1

AIR button
Controls the air jets

CLEAN button
Controls a ten-minute clean-up cycle

LIGHT button
Controls the interior & exterior lighting

JETS 2 button
Controls jet pump 2

Geneva™ • Niagara® • Tahitian®

Main Control Panel

TEMP (up) button
Increases the temperature

SET button
Used to initiate advanced panel features.

TEMP (down) button
Decreases the temperature

JETS 1 button
Controls jet pump 1

CLEAN button
Controls a ten-minute clean-up cycle

LIGHT button
Controls the interior & exterior lighting

JETS 2 button
Controls jet pump 2

Elation® • Aspire™

Auxiliary Panel

JETS 1 button
Controls jet pump 1

AIR button
Controls the air jets

LIGHT button
Controls the interior & exterior lighting

JETS 2 button
Controls jets pump 2 & Acquarella Waterfall

JETS 1 button
Controls jet pump 1

MODE button
Switches between spa mode and stereo mode

L/T/S button
Controls lighting, CD track and radio scan

JETS 2 button
Controls jets pump 2 & Acquarella Waterfall

Geneva • Niagara • Tahitian

Elation • Aspire

LOCKING FEATURES

The locking features, TEMPERATURE LOCK and SPA LOCK, are enabled from the control panel by a specific combination of buttons. Once enabled, a lock will remain active until the specific button combination is applied to disable the lock. Even if power is disconnected from the spa and soon thereafter reapplied (such as a power outage), the lock will remain in place.

SPA LOCK

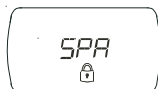

The Spa Lock feature deactivates all of the functions of the control panel. It is generally used to prevent unwanted use of the spa.

To activate the Spa Lock, press "SET" button + "TEMP ▼" button and hold for three seconds until the SPA and lock symbol are illuminated.

To deactivate the Spa Lock, press "SET" button + "TEMP ▼" button and hold for three seconds until the SPA and lock symbol are no longer illuminated.

OPERATING INSTRUCTIONS

TEMPERATURE LOCK



The Temperature Lock feature deactivates the temperature control function from the control panel. All other functions on the control panel will operate normally. Temperature Lock is most often used by those who do not want others to change the set temperature of the spa water.

To activate the Temperature Lock, press “SET” button + “TEMP ▲” button and hold for three seconds until lock symbol is illuminated.

To deactivate the Temperature Lock, press “SET” button + “TEMP ▲” button and hold for three seconds until the lock symbol is no longer illuminated.

ADVANCE MODE CONTROL (SET BUTTON)

The “SET” button is used to initiate advanced panel features such as the spa panel lock, temperature lock, display inversion, and color wheel mode.

MAIN CONTROL PANEL BUTTONS AND DISPLAY

Your spa control system consists of an illuminated Light Emitting Diode (LED) and convenient push buttons that allow you to set the water temperature, as well as the hydrotherapy jets, mood lighting, and optional jets from the spa control panel.

DISPLAY INVERSION

You may invert the main, four-digit display for easier viewing from inside the spa. Press and hold the “SET” button for three seconds until the display is inverted. Press and hold the “SET” button for three seconds a second time to invert the four-digit display back to its original position.

TEMPERATURE BUTTONS



The set temperature range is from 80°F to 104°F. Higher Temperatures can be reached by using one of the four codes: ut1, ut2, ut3 and ut4. These settings get progressively warmer, with ut4 the highest at approximately 106°F. (Temperatures of any setting may rise slightly depending on the current use and condition of your spa, and on outside temperature.)

The set temperature of the spa water will automatically be 102°F the first time power is applied. This is the setting programmed at the factory. After the spa has been set up and used, the last temperature value set by the user will be stored in memory. If power is disconnected from the spa, it will automatically revert to the last set temperature when power is reapplied.

To display the set temperature of the spa, press the “TEMP ▲” or “TEMP ▼” button. The set temperature will be displayed, unless the spa is locked (in which case the word SPA is displayed with the lock symbol). The set temperature display will automatically return to actual temperature after five seconds. To increase the set temperature of the spa water, press the “TEMP ▲” button. Each time the button is pressed, the set temperature display will increment by one degree. If the button is held down, the set temperature display will increase by one degree every half-second.

To decrease the set temperature of the spa water, press the “TEMP ▼” button. Each time the button is pressed, the set temperature display will decrement by one degree. If the button is held down, the set temperature display will decrease by one degree every half-second.

If the set temperature value will not change, check the TEMP LOCK and SPA LOCK features. When either of these features is applied, the temperature control is disabled.

JETS BUTTONS



There are two buttons which affect the jet pumps:

The “JETS 1” button activates jet pump 1. When the “JETS 1” button is pressed, the jets symbol will illuminate on the control panel display. The symbol will remain lit until the button is pressed again to turn off the jet pump 1, or after one hour of continuous operation when the pump is automatically shut off by the control system.

The “JETS 2” button activates jet pump 2. When the “JETS 2” button is first pressed, the pump is in low speed and the jets symbol illuminates on the control panel display. Pressing the button a second time switches the jet pump to high speed mode. The symbol will remain lit until the button is pressed a third time turning jet pump 2 off, or after one hour of continuous operation when the pump is automatically shut off by the control system.

MANUAL CLEAN BUTTON

The “CLEAN” button has been provided as a convenient timer for water maintenance. When the “CLEAN” button is pressed, Jet pump 1 will activate. The jet pump symbol will flash on and off until the cleaning cycle is complete. The total cleaning cycle time is ten minutes. If the clean cycle does not engage, make sure the SPA LOCK is deactivated. SPA LOCK disables the controls on both the main, and auxiliary control panels.

AUTOMATIC CLEAN CYCLE

The automatic clean-up cycle operates in the following manner:

- The air blower activates for one minute for Geneva™, Niagara® and Tahitian® spas
- Jet pump 2 runs for one minute
- Jet pump 1 runs for eight minutes (except for the Elation® and Aspire™ spas which runs for nine minutes).

This system is initiated five minutes after the spa is powered up, then once every 24 hours.

Press the “SET” + “CLEAN” button simultaneously to reset the 24 hour cycle time.

AIR JETS BUTTONS (Available on Geneva, Niagara and Tahitian spas)



The “AIR” button activates the air blower. When the “AIR” button is pressed, the air symbol will illuminate on the control panel display. The symbol will remain lit until the button is pressed to turn off the air blower, or after fifteen minutes when the blower is automatically shut off by the control system. While the air blower is on, air-only jets are operating throughout the spa. To stop the air blower when active, simply press the “AIR” button.

OPERATING INSTRUCTIONS

LIGHT BUTTON & SPAGLO® COLOR WHEEL



The "LIGHT" button activates the light, controls the intensity of the light, and is used to start and stop the SpaGlo™ color wheel. Pressing the "LIGHT" button operates the light as follows:

- 1st press of the "LIGHT" button – light will turn on to the maximum intensity.
- 2nd press of the "LIGHT" button – light will turn to medium intensity.
- 3rd press of the "LIGHT" button – light will turn to low intensity.
- 4th press of the "LIGHT" button – light will turn off.

Press the "SET" + "LIGHT" button simultaneously while the light is on to start or stop the SpaGlo color wheel. The light symbol will flash on and off while the SpaGlo color wheel is cycling through the six color options and the light symbol will display constant when the SpaGlo color wheel is stopped.

If the light is left on, it will automatically be turned off by the control system after six hours of continuous operation. The light symbol on the control panel will also turn off when the light is deactivated.

If the light will not turn on, make sure SPA LOCK is deactivated. SPA LOCK disables the controls on both the main and auxiliary control panel.

AUTOMATIC LIGHT FEATURE

The Automatic Light Feature allows you to set the SpaGlo lighting system to activate at the same time every day. Wait for the time of day you would like the automatic feature to start, then press and hold "TEMP ▲" and "LIGHT" button simultaneously for 3 seconds, the light then remains active for the next 6 hours. The lighting will turn on every day at the same time until you press and hold the "TEMP ▲" and "LIGHT" button simultaneously for 3 seconds a second time to deactivate the automatic light feature.

SUMMER MODE



Your Caldera® spa is equipped with a Summer Mode timer. The Summer Mode timer can be activated during extremely hot summer months if it becomes difficult to maintain water temperatures low enough for comfort. Upon switching to the ON mode, the heater will immediately shut down while the circulation pump (which can add heat to the water through normal operation) will remain on for approximately 5 minutes for heater cool-down. Both heater and circulation pump will remain off for the next eight hours. Additionally, the summer mode icon on the main control panel will

activate and remain active for as long as the summer mode is on. Following this eight-hour period, the circulation pump, heater, and ozone will continue to turn off for an eight-hour period every day that the switch remains in the ON position. In this way, the amount of heat transferred to the spa water will be minimized. When the outside temperatures begin to cool, the Summer Mode timer should be turned to the OFF position (the summer mode icon on the main control panel shut off). This is the efficient 24 hour circulation mode that keeps the heater operation and operating costs to a minimum during colder/heavier usage months.

NOTE: Whenever power is disconnected, and then reconnected to the spa, the Summer Mode timer will reset starting with the eight-hour shutdown mode. If a different eight-hour shut down time is desired, deactivate the Summer Mode, then reactivate at the beginning of the desired eight-hour shut down time.

IMPORTANT: The Summer Mode will not lower the spa's water temperature below the ambient air temperature.

To activate the Summer Mode, simply follow these steps:

1. Set the temperature control to 80°F
2. On the control panel, simultaneously press and hold for three seconds "TEMP ▲" and "TEMP ▼" to activate the Summer Timer.

The Summer Mode must be deactivated when cooler temperatures return. To do this, simply repeat step 2.

WARNING: Failure to deactivate the Summer Mode when the temperature drops below 32°F will result in freezing of the spa. Damage resulting from this situation is not covered under the terms of the warranty.

AUXILIARY CONTROL PANEL BUTTONS

The auxiliary control panel, conveniently located opposite the main control panel allows the user to activate the jets, air blower, and light.

JETS BUTTONS

The "JETS 1" button activates jet pump 1. When the "JETS 1" button is pressed, the jets symbol will illuminate on the main control panel display. The symbol will remain lit until the button is pressed again to turn off the jet pump 1, or after one hour of continuous operation when the pump is automatically shut off by the control system.

The "JETS 2" button activates jet pump 2. When the "JETS 2" button is first pressed, the pump is in low speed and the jets symbol illuminates on the control panel display. Pressing the button a second time switches the jet pump to high speed mode. The symbol will remain lit until the button is pressed a third time turning jet pump 2 off, or after one hour of continuous operation when the pump is automatically shut off by the control system.

AIR JETS BUTTONS (Available on Geneva™, Niagara® and Tahitian® spas)

The "AIR" button activates the air blower. When the "AIR" button is pressed, the air symbol will illuminate on the main control panel display. The symbol will remain lit until the button is pressed to turn off the air blower, or after fifteen minutes when the blower is automatically shut off by the control system. While the air blower is on, air only jets are operating throughout the spa. To stop the air blower when active, simply press the "AIR" button.

OPERATING INSTRUCTIONS

LIGHT BUTTON (Available on Geneva™, Niagara® and Tahitian® spas)

L/T/S BUTTON (Available on Elation® and Aspire™)

The "LIGHT" or "L/T/S" button activates the light and controls the intensity of the light. Pressing the "LIGHT" or "L/T/S" button operates the light as follows:

- 1st press of the "LIGHT" button – light will turn on to the maximum intensity.
- 2nd press of the "LIGHT" button – light will turn to medium intensity.
- 3rd press of the "LIGHT" button – light will turn to low intensity.
- 4th press of the "LIGHT" button – light will turn off.

If the light is left on, it will automatically be turned off by the control system after six hours of continuous operation. The light symbol on the main control panel will also turn off when the light is deactivated. If the light will not turn on, make sure SPA LOCK is deactivated. SPA LOCK disables the controls on both the main and auxiliary control panel.

MODE BUTTON (Available on Elation® and Aspire™)

Pressing the "MODE" button initiates a 5 second operating window to perform the following functions:

- Press "JETS 1/▲" button – to increase volume.
- Press "JETS 2/▼" button – to decrease volume.
- Press "L/T/S" button – to advance to the next track (in CD mode)
- Press "L/T/S" button – to advance to the next available station (in radio mode).

NOTE: Five seconds after the last button is pressed, the auxiliary panel defaults back to normal spa mode.

AQUATIC MELODIES® MUSIC SYSTEM

(Available on Elation and Aspire)

The Elation and Aspire comes equipped with the Aquatic Melodies Surround Sound system. The system includes the following:

- Magnadyne® CD AM/FM Stereo with equalizer.
- Three pop-up satellite speakers.
- Subwoofer with independent amplifier.

The operating instructions for both the CD AM/FM Stereo have been included in the spa's Owner's Packet.

SPEAKER OPERATION

Your Elation or Aspire spa is equipped with three pop-up speakers.

To operate the pop-up speakers:

1. Press the button next to the speaker.
2. Rotate the speaker to the desired position (the speaker can rotate in either direction until it stops).
3. The pop-up speaker will only lower in one position. To lower, rotate the speaker until the two arrows point towards each other, then press down on the top of the speaker until it locks into position.

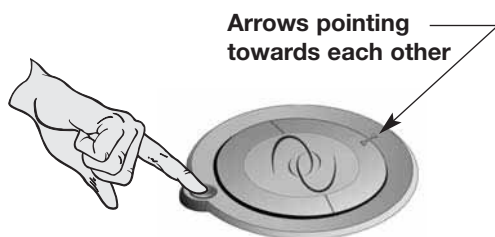

Press button to raise the speaker



**Speaker in initial raised position.
Rotate speaker to desired location.**



**Rotate speaker to return to the
initial raised position in order to
lower speaker.**

NOTE: Radio reception will vary depending on your location.

IMPORTANT: THE SPEAKER WILL ONLY LOWER IN ONE POSITION (WITH ARROWS ALIGNED), FORCING IT TO GO DOWN IN ANY OTHER POSITION WILL DAMAGE THE SPEAKER MECHANISM.

EQUIPMENT COMPARTMENT

JET PUMP SIDE

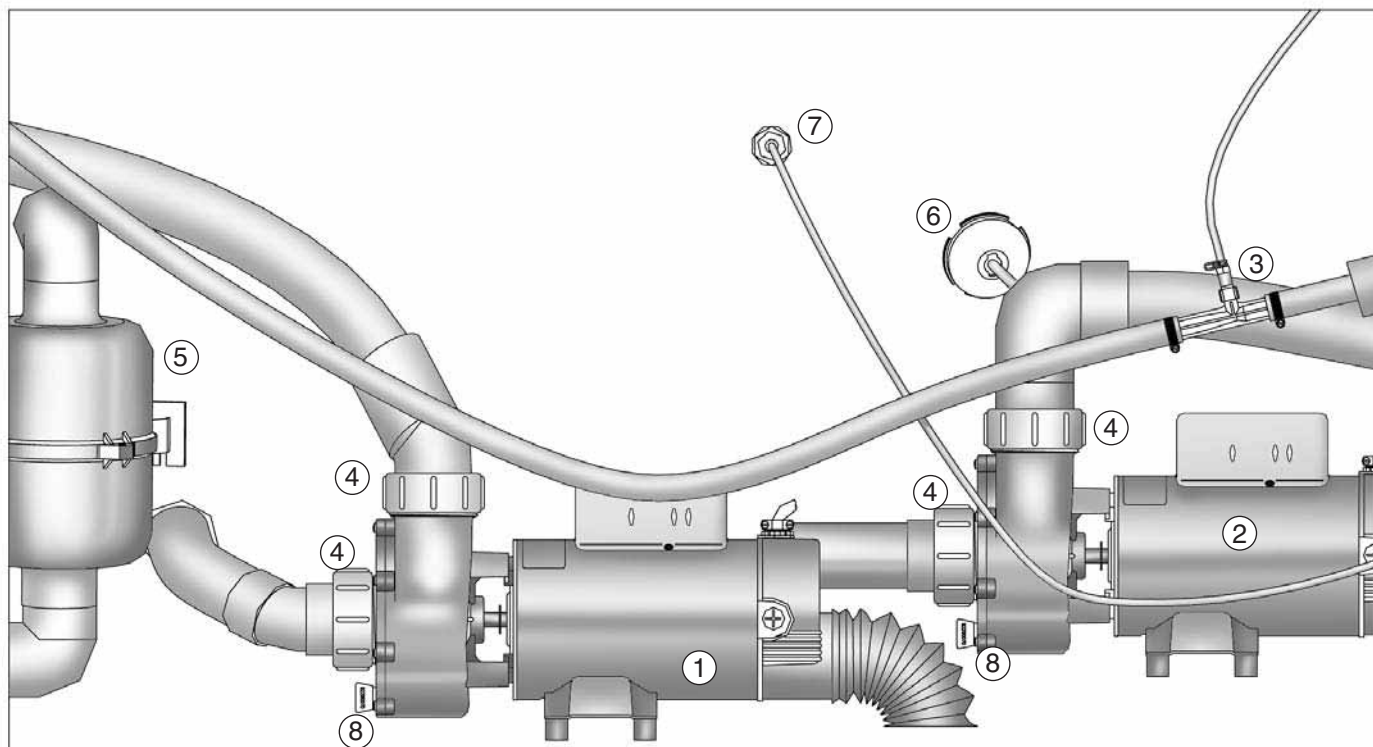

1. Jet Pump #1
2. Jet Pump #2
3. Ozone Injector
4. Unions
5. Air Blower*
6. Light
7. Temperature Sensor
8. Pump Drain Plug

* Air Blower available on Geneva™, Niagara® and Tahitian® spas only

EQUIPMENT COMPARTMENT

CONTROLS SIDE

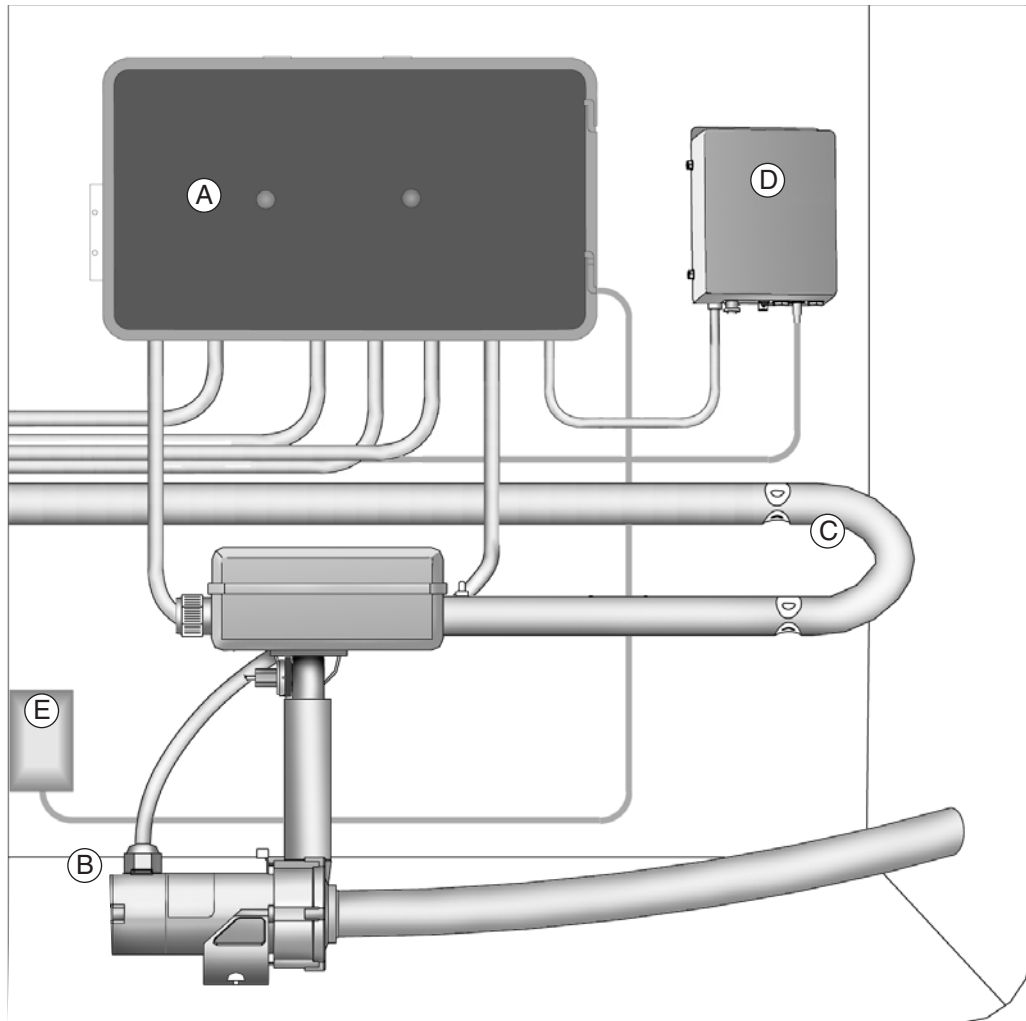

- A. Advent™ System Control Box
- B. EnergyPro® Circulating Pump
- C. EnergyPro Flow-Through Heater
- D. Monarch® CD Ozone Generator
- E. SpaGlo™ LED Light Controller

MAINTENANCE

FILTER LID REMOVAL & REPLACEMENT

Attached to the underside of the filter lid is a reservoir with a fiber optic cable and water supply tube, each of which is connected to couplings in the skimmer compartment wall. To remove the lid, pull it towards center of spa while lifting upward.

To replace filter lid, align the fiber optic cable with the small coupling and the water supply tube with the large coupling while lowering the lid into position. Verify water supply tube is securely inserted into large coupling before starting Jet Pump 2.

FILTER MAINTENANCE

At least once a week, check and clean the skimmer basket and weir to ensure proper filter flow. Remove leaves, foreign matter, and debris. It is very important to keep your spa filter cartridge clean and free of particles to ensure proper water flow. A clean filter permits the hydrotherapy system to function properly and also allows more efficient filter cycles. Depending on how frequently your spa is used, we recommend cleaning the spa filter cartridge every four weeks. If this is not done, the filter may clog and restrict water flow, which causes improper filtration, poor jet performance and possibly freeze.

IMPORTANT: The frequency and duration of use, and the number of occupants all contribute to determining the appropriate time between filter cleanings. More use means that more frequent filter cleanings will be required.

FILTER CARTRIDGE REMOVAL AND CLEANING INSTRUCTIONS

Turn the power to the spa off, then proceed as follows:

1. Push down slightly and turn filter basket counter-clockwise to unlock, then pull out the basket and weir.
2. Carefully pull up the filter cartridge and bring it out of the spa.
3. Always clean the filter using a filter degreaser to remove mineral and oil build-up. Simply soak the filter in the degreaser (according to the package directions), then place the filter on a clean surface and spray until clean using a garden hose. It may be necessary to rotate the filter while spraying to remove any debris lodged between the filter pleats. Re-insert filter cartridge.
4. To return basket and weir, insert and rotate clockwise to lock into position. Then, turn spa's power back on.

NOTE: Replacement filter cartridges are available from your Caldera® dealer. Refer to the back of this manual to determine the appropriate size for your spa.

DIVERTER VALVE MAINTENANCE

If your spa's diverter valves become difficult to turn, it is likely that sand or grit has become lodged inside the valve body. It is very important that this debris is removed as soon as possible to avoid damage to the valve. To accomplish this, follow this procedure:

1. Turn off power to the spa by tripping both GFCI breakers located in the subpanel.
2. Remove the diverter valve's handle by pulling upward while rocking it back and forth.
3. Unscrew the cap ring.
4. Remove the valve body by pulling it upward.
5. Wipe the valve body and the interior walls of the valve clean.
6. Lubricate the o-rings with a waterproof lubricant available from your Caldera dealer.
7. Reassemble the valve and turn power to the spa on.

VERSASSAGE® & ORBISSAGE™ JETS MAINTENANCE

If you notice that the VersaSsage or OrbiSsage jet spins slower than when the spa was new, or the jets are sticking, the cause is built-up of deposits inside the jet bearings. To remove the deposits, use the following instructions:

1. With the spa off, rotate the VersaSsage jet face counter-clockwise until it stops.
2. Once the face stops rotating, use a little extra force to rotate the face even more counter-clockwise past the locking position until it stops. Pull face with the body away from the spa.
3. After flushing the bearing inside the body with water, spin the rotating eye, it should spin very freely. If it does not, place the bearing end in a cup of vinegar (the vinegar will soften any deposits). Leave soaking overnight. The next day, flush with water and repeat the spin test.

NOTE: If it still doesn't spin freely, a second night of soaking is required. If the bearing still does not spin, you will need to purchase a replacement assembly from your Caldera® dealer.

4. To replace, position the cutout at the back end of the face body downward and push the face body back into the spa fitting. Slightly rotate face body in either direction until you feel the body align with the fitting, then press firmly on the face body. Once seated, rotate the face clockwise using a little extra force to overcome the locking position. If the face does not rotate, remove and rotate face body 180° and repeat this step. Turn the jet pump on, the VersaSsage jet should spin freely.

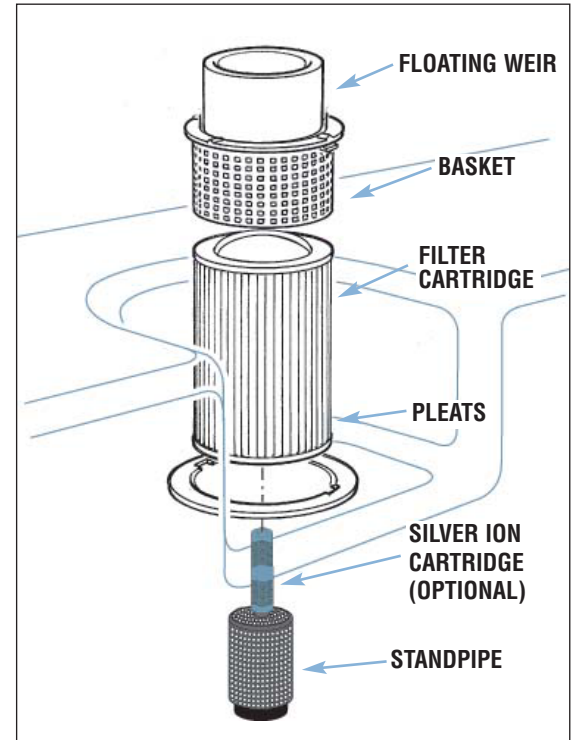

MAINTENANCE

DRAINING YOUR SPA

1. Turn off all GFCI breakers in sub-panel, or main electrical panel.
2. Locate the main drain valve for the spa. Pull on handle (Step 1) until you reach the mid position then rotate handle slightly to fully extended drain tube (drain cap and 1" of the drain tube is exposed) (Step 2) then remove the drain cap (Step 3) . **NOTE:** You will not be able to remove drain cap in mid position. Attach the garden hose to the end of the drain (to avoid flooding of the foundation surrounding the spa) making sure not to push the drain tube inwards. Route the outlet of the hose to an appropriate draining area.

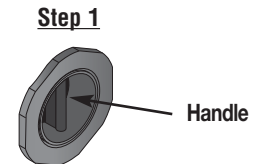
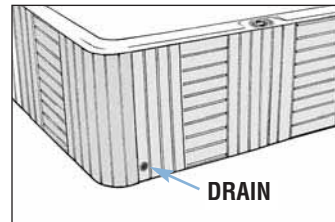

NOTE: Spa water with a high sanitizer level may harm plants and grass.

3. Push the garden hose and drain tube half-way back towards the spa (Step 4) which will start the gravitational flow. Drain tube must be in the mid position for the spa to drain.

IMPORTANT: All models will drain almost completely through the drain valve. Equipment such as the jet pump and heating system may not completely drain. Any water remaining within the plumbing or equipment after draining will only need to be removed if the spa is being winterized.

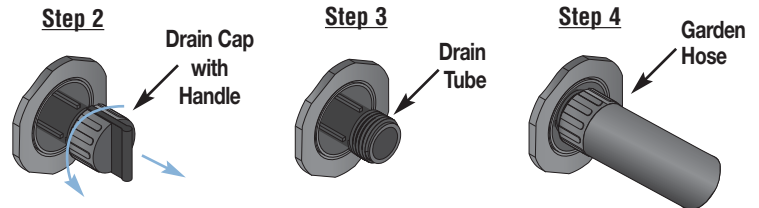

4. After your spa is empty, clean the shell and filter cartridge.
5. Pull and remove garden hose, replace drain cap and push drain tube back into spa as seen in Step 1.
6. Follow the "START-UP AND REFILL PROCEDURES" to refill your spa.

WINTERIZING YOUR SPA

For expert winterizing of your spa, contact your authorized Caldera Dealer.

If you wish to leave your spa empty and it is located where freezing temperatures occur, follow steps 1 thru 5 outlined in "Draining Your Spa", then complete the following steps:

NOTE: MAKE CERTAIN ALL POWER TO THE SPA IS OFF BEFORE YOU CONTINUE.

To help remove residual water in the air jet plumbing use one of the following steps:

1. Locate the 10 air jets (Utopia series only) and use a wet/dry vacuum to remove the water out of each air jet. (See air jet diagram in Air Jet section)
2. Or turn the 30 amp breaker on. Immediately after, turn the blower on by pushing the air button, then wait for 3 to 10 seconds, or until you notice that the air is not coming out of the air jets. Push the air button again to turn the blower off.

NOTE: Stand back to avoid any spray. Turning on the blower will help evacuate residual water in the air jet lines.

TURN THE CIRCUIT BREAKER OFF IMMEDIATELY AFTER COMPLETING STEP # 2.

NOTE: Remove the excess water with a wet/dry vacuum or a sponge.

3. It will be necessary to remove all water from the interior plumbing.
4. Remove the filter lid, floating weir, basket, filter cartridge and standpipe. Insert a shop vacuum hose into the suction line located in the bottom of the filter compartment (operate in the blow mode). If the vacuum hose does not fit tight into the opening, air will escape. It might be necessary to wrap a rag around the vacuum hose to make an air-tight seal.
5. Attach the vacuum hose to the **vacuum side** of the shop vac. Remove the water starting with the jets at the top and moving to the ones at the bottom of the spa.
NOTE: When removing the water from jet openings, you may notice suction coming from another jet. With the help of a second person, block off any suction from the other jet using a large rag or cloth. This will help pull out the water that is trapped deep inside the main line.
6. Thoroughly dry the spa shell with a clean towel.
7. Pour anti-freeze into the filter suction fittings, jet outlets, and diverters. Add enough anti-freeze until the liquid starts to come out of the bottom drain.
⚠ **CAUTION: Use only Propylene glycol as your anti-freeze. This is non-toxic. NEVER use automobile anti-freeze since it is toxic.**
8. Close the spa cover and fasten the cover tie downs. If your area receives a lot of snow or ice, it is recommended to cover the spa cover with two pieces of plywood forming a pitched roof top to prevent snow and ice build-up. Secure a plastic sheet or tarp over the spa cover and one over the plywood.
9. Replace the equipment compartment door and secure with screws.
10. Remove pump doors by first removing the drain collar then the door screws. Once door is removed unscrew the pump drain plugs located on the front of the pump housings. Allow all water to drain out. Place the drain plugs in a ziplock bag and store near the pumps. Replace the drain plugs on start-up. (Refer to the Figure on
11. Unscrew the pump unions and allow the water to drain. Leave unions loose.
12. Replace the pump doors and secure with screws.

NOTE: DO NOT LEAVE ANY WATER IN YOUR SPA.

⚠ **WARNING:** When not in use, the spa must be covered with a vinyl spa cover. Damage caused by either sun exposure or freezing is not covered under warranty.

Opening Instructions:

13. Remove plastic, plywood, and spa cover. Remove pump doors by first removing the drain collar then the door screws. Once doors are open, reinstall drain plugs and hand tighten pump union. Follow the "START-UP AND REFILL PROCEDURES" to refill your spa.

MAINTENANCE

CARE OF THE SPA PILLOWS

The spa pillows will provide years of comfort if treated with care. They have been positioned above the water level to minimize the bleaching effects of chlorinated water and other spa water chemicals. To extend their life, whenever the spa shell is being cleaned, the spa pillows should be removed and cleaned. Body oils can be removed with a mild soap and water solution. ALWAYS rinse off the spa pillows thoroughly to remove any soap residue. If the spa is not going to be used for a long period of time (that is during a vacation or if the spa is winterized), or when the spa water is being super-chlorinated, the spa pillows should be removed until the next use of the spa.

To remove and replace the spa pillows:

1. Carefully lift one end of the pillow away from the spa shell.
2. Continue lifting one end until all pillow retainers are released from the pillow.

IMPORTANT: Just pulling the pillow straight up and out of the shell recess will eventually damage the pillow. This abuse is not covered under warranty.

3. To reinstall the spa pillow, carefully bend the pillow slightly to allow one of the pillow retainers to slip into the recess in the back of the pillow.
4. Keeping the pillow slightly bent, slide the other pillow retainer into the recess in the back of the pillow.
5. After all the pillow retainers are in place, press the pillow down into the recess in the spa shell.

CARE OF THE EXTERIOR

SPA SHELL

Your Caldera® spa has a granite like or Pearlescent shell. Stains and dirt generally will not adhere to your spa's surface. A soft rag should easily remove most dirt. Most household chemicals are harmful to your spa's shell. The only products which have passed the manufacturer's tests are Soft Scrub® and Windex®. Sodium bicarbonate (baking soda) can also be used for minor surface cleaning. Always thoroughly rinse off any spa shell cleaning agent with fresh water.

SERVICE NOTES:

1. Iron and copper in the water can stain the spa shell if allowed to go unchecked. Your Caldera Dealer can recommend a stain and scale inhibitor to use if your spa water has a high concentration of dissolved minerals.
2. The use of alcohol or any household cleaners other than those listed to clean the spa shell surface is NOT recommended. DO NOT use any cleaning products containing abrasives or solvents since they may damage the shell surface. **NEVER USE HARSH CHEMICALS!** Damage to the shell by the use of harsh chemicals is not covered under the warranty.

IMPORTANT: Some surface cleaners contain eye and skin irritants. Keep all cleaners out of the reach of children and use care when applying.

SPA SKIRT

When cleaning the skirt of your spa, use only a soft cloth or sponge with a mild soap and water solution. The use of an abrasive type cleaner or applicator will be harmful to the exterior finish. Always thoroughly rinse off the spa skirt with fresh water.

CARE OF THE SPA COVER

⚠ **WARNING:** The cover is a manual safety cover that meets or exceeds all prevailing requirements of ASTM Standards for spa safety covers when installed and used correctly as of the date of manufacture. Non-secured or improperly secured covers are a hazard. Open the cover to its fully open position before use.

VINYL COVER

The vinyl spa cover is an attractive, durable foam insulation product. Monthly cleaning and conditioning are recommended to maintain its beauty.

To clean and condition the vinyl cover:

1. Remove the cover from the spa and gently lean it against a wall or fence.
2. With a garden hose, spray the cover to loosen and rinse away dirt or debris.
3. Using a large sponge and/or a soft bristle brush, and using a very mild soap solution (1 teaspoon dishwashing liquid with 2 gallons of water) or baking soda (sodium bicarbonate), scrub the vinyl top in a circular motion. Do not let the vinyl dry with a soap film on it before it can be rinsed clean.
4. Scrub the cover's perimeter and side flaps. Rinse clean with water.
5. Rinse off the underside of the cover with water only (use no soap), and wipe it clean with a dry rag.

SERVICE NOTE: To remove tree sap, use cigarette lighter fluid (not charcoal lighter fluid). Use sparingly, and rinse with a saddle soap solution immediately afterwards, then wipe dry.

Important reminders:

- **DO** remove snow buildup to avoid breakage of the foam core from the additional weight of the snow.
- **DO** lock cover lock straps to secure the cover when the spa is not in use.
- **DO NOT** drag or lift the spa cover using either the flaps or the cover lock straps.
- **DO NOT** walk, stand, or sit on the cover.
- **DO NOT** place any metal or heat transferring object on the cover or place any type of plastic tarp or drop cloth over the cover as this may result in a melted foam core, which would not be covered under the warranty.
- **DO NOT** use any lifting mechanisms, chemicals or cleaners except those recommended by Watkins® Manufacturing Corporation or its Authorized Sales and Service Dealer.

WATER QUALITY AND MAINTENANCE

It's important to have clean water. Water maintenance is one of the least understood, yet most important areas of spa ownership. Your dealer can guide you through the process of achieving and maintaining perfect water in your spa, given your local conditions. Your program will depend on your water's mineral content, how often you use your spa, and how many people use it.

GENERAL INFORMATION

THE THREE FUNDAMENTAL AREAS OF WATER MAINTENANCE:

- **Water Filtration**
- **Chemical Balance/pH Control**
- **Water Sanitation**

Water Sanitation is the responsibility of the spa owner, achieved through the regular and periodic (daily, if necessary) addition of an approved sanitizer. The sanitizer will chemically control the bacteria and viruses present in the fill water or introduced during use of the spa. Bacteria and viruses can grow quickly in undersanitized spa water.

The water's chemical balance and pH control are also the responsibility of the spa owner. You'll have to add chemicals to maintain proper levels of Total Alkalinity (TA), Calcium Hardness (CH) and pH. Proper water balance and pH control will minimize scale buildup, extend the life of the spa, and allow the sanitizer to work at an optimum level.

METHODS FOR TESTING THE SPA WATER

Accurate water testing and analysis is an important part of effectively managing your spa water. You must have the ability to test for:

- Total Alkalinity (TA)
- Calcium Hardness (CH)
- pH
- Sanitizer

Two types of testing methods are recognized and recommended by Watkins® Manufacturing Corporation:

The Reagent Test Kit is a method which provides a high level of accuracy. The reagents come in either liquid or tablet form.

Test Strips are a convenient testing method used by many spa owners. Keep in mind that test strips are susceptible to heat and moisture contamination, which will result in inaccurate readings.

IMPORTANT: Always read and carefully follow the directions included with the Test Kit or Test Strips to ensure the accuracy of the test results.

BASIC CHEMICAL SAFETY

When using chemicals, read the labels carefully and follow directions precisely. Though chemicals protect you and your spa when used correctly, they can be hazardous in concentrated form. Always observe the following guidelines:

- Allow only a responsible person to handle spa chemicals. **KEEP THEM OUT OF THE REACH OF CHILDREN.**
- Accurately measure the exact quantities specified, never more. Do not overdose your spa.
- Handle all containers with care. Store in a cool, dry, well ventilated place.
- Always keep chemical containers closed when not in use. Replace caps on their proper containers.
- Don't inhale fumes or allow chemicals to come in contact with your eyes, nose, or mouth. Wash your hands immediately after use.
- Follow the emergency advice on the product label in case of accidental contact, or if the chemical is swallowed. Call a doctor or the local Poison Control Center. If a doctor is needed, take the product container along with you so that the substance can be identified.
- Don't let chemicals get on surrounding surfaces or landscaping.
- Don't use a vacuum cleaner to clean up chemical spills.
- Never smoke around chemicals. Some fumes can be highly flammable.
- Don't store any chemicals in the spa equipment compartment.

HOW TO ADD CHEMICALS TO THE WATER

IMPORTANT: All spa water chemicals, including granulated dichlor, MPS (monopersulphate) granulated pH increaser or decreaser, granulated total alkalinity increaser, calcium hardness increaser, liquid stain and scale inhibitor, and liquid de-foamer must always be added directly into or in front of the filter compartment while the jet pump is running, and it must run for a minimum of ten minutes.

To Administer Spa Water Chemicals:

1. Fold back the cover.
2. Push the "CLEAN" button to turn on the jet pump.
3. Carefully measure the recommended amount of chemical and slowly pour it into or in front of the filter compartment. Use care not to splash chemicals on your hands, in your eyes, on the spa shell surface or on the siding.
4. After ten minutes, shut off the jet pump(s) and close and lock the cover to complete the procedure. **Risk of Drowning:** Never leave an open spa unattended!

⚠ **WARNING:** High sanitizer levels can cause discomfort to the user's eyes, lungs and skin. Always allow the sanitizer level to fall to the recommended range before using the spa.

WATER QUALITY AND MAINTENANCE

IMPORTANT “SUPER CHLORINATION/NON-CHLORINE SHOCK TREATMENT” NOTE: After administering a super chlorination treatment or non-chlorine shock to your spa, leave the cover open for a minimum of 20 minutes to allow the oxidizer gas to vent. A high concentration of trapped oxidizer gas which may exist as a result of the shock treatment (not daily sanitation) may eventually cause discoloration or vinyl degradation to the bottom of the cover. This type of damage is considered chemical abuse and is not covered under the terms of the limited warranty.

THE WATKINS® SPA WATER MAINTENANCE PROGRAM

Each step in your water maintenance program is dependent on the completion of the previous steps. Omitting a step or failing to reach the recommended range may cause an imbalance in your water's chemistry. Unbalanced water chemistry can damage the spa and its components, as well as cause discomfort for the user.

BALANCING THE TOTAL ALKALINITY (TA)

- The recommended Total Alkalinity (TA) for your spa water is 125-150 ppm.
- Total Alkalinity is a measure of the total levels of carbonates, bicarbonates, hydroxides, and other alkaline substances in the water. TA is referred to as the water's "pH buffer". In other words, it's a measure of the ability of the water to resist changes in pH level.
- If the TA is too low, the pH level will fluctuate widely from high to low. Fluctuations in pH can cause corrosion or scaling of the spa components. **Low TA can be corrected by adding sodium hydrogen carbonate (pH/Alkalinity Up).**
- If the Total Alkalinity is too high, the pH level will tend to be high and may be difficult to bring down. **It can be lowered by using sodium bisulfate (pH/Alkalinity Down).**
- Once the TA is balanced, it normally remains stable, although the addition of more water with a high or low alkalinity will raise or lower the TA reading of the water.
- When the Total Alkalinity is within the recommended range, proceed to the next step.

BALANCING THE CALCIUM HARDNESS (CH)

- The recommended Calcium Hardness (CH) level for your spa is 150-200 ppm.
- Calcium Hardness is a measure of the total amount of dissolved calcium in the water. Calcium helps control the corrosive nature of the spa's water. That's why calcium-low water (commonly known as "soft" water) is not recommended. It is very corrosive to the equipment, and can cause staining of the spa shell.
- If the CH is too high (commonly known as "hard water"), formation of scale on the spa's shell surface and equipment can result. **CH can be decreased by dilution—a mixture of 75% hard and 25% soft water will usually yield a reading within the correct range.** If soft water is not available or practical for you, a stain and scale inhibitor should be added to the spa water, according to label instructions.
- If the CH is too low add CH Increaser.
- Once the CH is balanced, it normally remains stable, although the addition of more water with a high or low calcium content will raise or lower the CH reading of the water.
- When the Calcium Hardness is within the recommended range, proceed to the next step.

BALANCING THE pH

- The recommended pH level for your spa water is 7.4-7.6.
- The pH level is the measure of acidity and alkalinity. Values above 7 are alkaline; those below 7 are acidic. Maintaining the proper pH level is extremely important for:
 - Optimizing the effectiveness of the sanitizer.
 - Maintaining water that is comfortable for the user.
 - Preventing equipment deterioration.
- If the spa water's pH level is too low, the following may result:
 - The sanitizer will dissipate rapidly.
 - The water may become irritating to spa users.
 - The spa's equipment may corrode.

If the pH is too low, it can be increased by adding sodium hydrogen carbonate (pH/Alkalinity Up) to the spa water.

- If the pH level is too high, the following may result:
 - The sanitizer is less effective.
 - Scale will form on the spa shell surface and the equipment.
 - The water may become cloudy.
 - The filter cartridge pores may become obstructed.

If the pH is too high, it can be decreased by adding sodium bisulfate (pH/Alkalinity Down) to the spa water.

NOTE: After adding sodium hydrogen carbonate, or sodium bisulfate, **wait two hours** before testing the water for pH. Measurements taken too soon may not be accurate.

- It is important to check the pH on a regular (weekly) basis. The pH will be affected by the bather load, the addition of new water, the addition of various chemicals, and the type of sanitizer used.
- When the pH is within the recommended range, proceed to the final step.

ALKALINE SPA WATER (SCALING ZONE)	8.2	ADD pH DECREASER TO LOWER pH
	7.8	
	7.6	
COMFORT ZONE	7.4	IDEAL
ACIDIC SPA WATER (CORROSIVE ZONE)	7.2	ADD pH INCREASER TO RAISE pH
	6.8	
	pH	

WATER QUALITY AND MAINTENANCE

MAINTAINING THE SANITIZER LEVEL

- A. Sanitizer is extremely important for killing algae, bacteria and viruses, and preventing unwanted organisms from growing in the spa. At the same time, you don't want too high a sanitizer level, or it can irritate your skin, lungs, and eyes.
- B. Always maintain the sanitizer level in your spa at the recommended level for each type of sanitizer.
- C. Watkins® recommends only the following sanitizers:
- Sodium Dichloro-s-Triazinetrione (sodium dichlor or chlorine)
 - Baqua Spa™ (please consult your Baqua Spa™ manual for instructions on the use of this product).
 - Brominating Concentrate™ (one step granular bromine)
- ⚠ **WARNING:** DO NOT use tri-chlor chlorine, bromo-chloro-dimethyl-hydantoin (BCDMH), or any type of compressed bromine or chlorine, acid or any type of sanitizer which is not recommended by Watkins Manufacturing Corporation.

THE WATKINS WATER MAINTENANCE QUICK REFERENCE GUIDE				
Steps	Ideal Range (ppm)		What Chemicals to Use	
	Minimum	Maximum	To Raise	To Lower
1 Total Alkalinity	125	150	Sodium Hydrogen Carbonate, or Sodium Bicarbonate	Sodium Bisulfate
2 Calcium Hardness	150	200	Calcium Hardness Increaser	Use a mixture of 75% hard water and 25% soft water or use a Stain and Scale Inhibitor
3 pH	7.4	7.6	Sodium Hydrogen Carbonate	Sodium Bisulfate
4 Sanitizer	See section on Maintaining the Sanitizer Level			

MONARCH® SILVER CARTRIDGE SYSTEM

The silver cartridge system is comprised of the following products:

- **Sodium Dichlor (chlorine)** is the only recommended sanitizer that will work in conjunction with all of the other products in this system.
- **Monopersulfate (MPS)** is an oxidizing chemical used to prevent the buildup of contaminants, maximize sanitizer efficiency, minimize combined chlorine, and improve water clarity.
- **Monarch silver cartridge** introduces silver ions into the spa water, inhibiting bacteria growth. When combined with MPS or chlorine, oxidizes particulates in the spa water.

It is important to follow the recommended application and maintenance programs outlined for each product's use.

If the spa is being used over an extended period or time, such as a whole afternoon or evening, additional sanitizer will be needed.

A weekly "shock treatment" is required.

The shock treatment quickly destroys any remaining contaminants while revitalizing the silver cartridge, allowing the silver ions to continue to be released into the water. Without this weekly shock treatment, the silver cartridge may stop releasing silver ions into the water.

To weekly "shock treat" your spa you may use either MPS or sodium dichlor. It will require much less sodium dichlor to administer the shock treatment than MPS (1 teaspoon of sodium dichlor has oxidizing capabilities comparable to 2 tablespoons of MPS). Sodium dichlor may be a more appropriate weekly shock for those users that experience heavy bather load conditions.

IMPORTANT NOTE: MPS is an oxidizer, not a sanitizer.

MONARCH SILVER CARTRIDGE REPLACEMENT INSTRUCTIONS

When replacing the silver cartridge (every four months), it is highly recommended that the spa be drained and refilled at the same time. After refilling the spa with water, balance the Total Alkalinity (TA), Calcium Hardness (CH) and pH to the recommended levels. Shock the spa by adding sodium dichlor.

1. Release the cover locks and fold back the cover.
2. Remove the filter compartment cover (see Filter Lid Removal instructions).
3. Make sure the filter compartment is clear of any floating objects.
4. Drain the spa using the recommended procedures found in the Owner's Manual.

WATER QUALITY AND MAINTENANCE

PLEASE NOTE: The Monarch[®] silver cartridge **CANNOT** be used with bromine, sodium bromide or biguanides. If you have previously used any of these products in the spa, it is recommended that the shell and filter compartment be cleaned. It is also recommended that the filters be cleaned with a filter cleaner before the Monarch cartridge is installed. (Review the shell and filter cleaning procedures.)

5. Push down slightly and turn filter basket counter-clockwise to unlock, then pull out the basket and weir.
6. Grab handle and lift filter straight up and out.

IMPORTANT NOTICE: If you have used the spa prior to this installation, clean the filter to ensure the Monarch silver cartridge performs optimally. It is recommended to clean the filter each time you replace the Monarch cartridge.

7. Position the stem of cartridge into the top of the filter standpipe.
8. Carefully replace the filter, the filter basket and weir.
9. Fill the spa as recommended (see Start-Up and Refill Procedures).
10. Replace the filter lid.
11. Fold the cover back into place.

⚠ **WARNING:** Never use the spa with the filter cartridge, basket, or weir removed.

SILVER ION QUESTIONS AND ANSWERS

Questions: How are the silver ions added to the water?

Answers: The silver cartridge contains ceramic beads that are infused with silver. By placing the cartridge in the filter standpipe, it is subject to the flow of water created by the operation of the 24 hour circulation pump. The flowing water, through a chemical erosion process, carries with it the silver ions necessary to add a sanitizing residual to the spa water.

Questions: What happens if I do not add the weekly shock treatment?

Answers: The contaminants in the water may coat the silver cartridge's ceramic beads, blocking the silver ions' release into the water. When this occurs, there will be no residual of silver ions present in the water, eliminating them from the sanitizing process.

Questions: How often should the Monarch Silver cartridge be replaced?

Answers: The cartridge must be replaced every four months. Please refer to the instructions provided with each Monarch silver cartridge.

Questions: Why can't I use bromine or biguanides instead of MPS or chlorine?

Answers: Bromine or biguanides will chemically react with the sanitizing action of the silver ions. This will eliminate their beneficial sanitizing effect.

DOS AND DON'TS

- **DO check your MPS or dichlor chemical level prior to each use.**
- **DO change the Monarch silver cartridge every 4 months.**
- **DO test Total Alkalinity and pH weekly.**
- **DO check your sanitizer prior to each use.**
- **DO use Monopersulfate (MPS) chlorine-free oxidizer for spas only.**
- **DO store all chemicals in a tightly sealed container in a cool, dry place.**
- **DON'T use bromine, sodium bromide or biguanides. These are an active sanitizer and will combine with the silver ions to inactivate them.**
- **DON'T use a water clarifier; Clarifiers will cause the spa water to become cloudy.**

CHLORINE (SODIUM DICHLOR)

- A. Sanitizing chemicals, such as chlorine, are oxidants that kill bacteria and viruses in the water. The Free Available Chlorine (FAC) is a measure of the amount of unused chlorine available to sanitize the spa. The recommended FAC for your spa water is 3.0-5.0 ppm.
- B. Watkins[®] Manufacturing Corporation recommends the use of sodium dichlor type granulated chlorine for sanitizing the water. Sodium dichlor is preferred because it is totally soluble, dissolves quickly and is nearly pH neutral.
- C. Maintaining the proper level of chlorine during use is extremely important.
- D. If the FAC is too low, bacteria and viruses can grow rapidly in the warm water. **Increase the FAC by adding granulated sodium dichlor.**
- E. If the FAC is too high, the water can cause discomfort to the user's eyes, lungs and skin. **Simply allow some time to pass. The FAC level will drop naturally over time.**
- F. When the Free Available Chlorine is within the recommended range, the spa is ready to be enjoyed.

⚠ **WARNING:** There are several forms of stabilized chlorine available for use in spas and swimming pools and each form has specific chemical characteristics. It is extremely important that the one you choose is specifically designed for use in spas. Use of an incorrect product such as tri-chlor, which has a very low pH (2.6), dissolves too quickly in hot water resulting in extremely high levels of chlorine, and is designed for concrete or plaster swimming pools, **WILL** cause damage to your spa. Use of a liquid, or any type of compressed bromine or chlorine, acid or any type or sanitizer which is not recommended

CHLORINE DPD TEST KIT OR TEST STRIP READING	DO NOT USE THE SPA UNTIL THE TEST KIT READING IS BELOW THIS LEVEL
5.0	RECOMMENDED LEVEL SAFE
4.0	
3.0	
2.0	ADD CHLORINE
1.0	DO NOT USE SPA ; ADD CHLORINE TO REACH RECOMMENDED SAFE LEVEL
0	

WATER QUALITY AND MAINTENANCE

by Watkins® Manufacturing Corporation **WILL** damage your spa and is specifically not covered under the terms of the limited warranty.

IMPORTANT: Granulated chlorine (sodium dichlor) will degrade if stored improperly. We recommend purchasing chlorine in one, two, or five pound containers and storing it in a cool, dry place to maintain its potency.

SUPER CHLORINATION

Super Chlorination is designed to “burn-off” the build-up of chloramines (used chlorine), to eliminate the chlorine smell and to allow the proper level of free chlorine to be maintained.

When giving your water a super chlorination treatment, open the cover at least half way for twenty minutes to allow the chlorine gas to vent off. The high concentration of chlorine gas which may exist as a result of super chlorination (not daily sanitation) may eventually cause discoloration or degradation to the bottom of the cover, which would not be covered under the terms of your warranty.

IMPORTANT: Always allow the Free Available Chlorine to fall below 5 ppm before using the spa.

WARNING: Never leave an open spa unattended, especially if there are children present!

BUILDING A SANITIZER ROUTINE

During the first month of ownership, measure the sanitizer residual daily in order to establish standards for User Load and Usage Time versus Sanitizer Needed.

- The User Load of the spa is the number of times anyone enters the spa.
- The Usage Time is simply the amount of time a user spends in the spa.
- Sanitizer Needed is the amount of Free Available Chlorine (FAC) needed to accommodate the number of users and their combined usage time.

For example, two spa users who regularly use the spa once an evening for twenty minutes create a specific and somewhat consistent demand on the sanitizer. During the first month of ownership, these two users can determine exactly how much sanitizer to use in order to maintain the proper residual. If, at any time, the user load and/or usage pattern changes dramatically (invited guests), the amount and frequency of sanitizer required increases dramatically. The greater the usage time, or the bather load, the faster the residual value is diminished.

SUPPLEMENTAL WATER MAINTENANCE

Proper water sanitation and mineral balance (pH control) are absolutely essential for a complete spa water maintenance program. Here are three other popular water additives that are optional:

WATKINS® WATER TREATMENT GUIDE	
<i>At spa startup or refill</i>	Follow spa Start-Up and Refill Procedures.
<i>Prior to each use</i> (Test before adding any chemicals; do not add any chemicals if proper or higher levels are found.)	Add one-half (1/2) teaspoon of sodium dichlor per 250 gallons, OR Add one (1) tablespoon monopersulfate (MPS)* per 250 gallons
<i>Once a week</i>	Add one and one half (1-1/2) teaspoons of sodium dichlor per 250 gallons, OR Add three (3) tablespoon monopersulfate (MPS)* per 250 gallons
<i>Every four months</i>	Drain and refill your spa. Follow spa Start-Up and Refill Procedures.
<i>As needed</i> (If water is hazy, cloudy or has an odor)	Add one and one half (1-1/2) teaspoons of sodium dichlor per 250 gallons.

* MPS is an oxidizer, not a sanitizer

Mineral Deposit Inhibitors

As water evaporates from your spa and new water is added, the amount of dissolved minerals will increase. (Minimize evaporation by keeping the cover on the spa whenever possible.) The spa water may eventually become “hard” (Calcium Hardness too high) enough to damage the heater by calcifying its surface. Proper pH control can minimize this.

Normal soap build-up will require water replacement regularly enough that mineral deposits normally are not a problem.

Occasionally, high iron or copper content in the water may produce green or brown stains on the spa. A stain and scale inhibitor may help to reduce these metals.

NOTE: Well water may contain high concentrations of minerals. The use of a low water volume, extra-fine pore water filter will help to remove many of the larger particles during the filling of the spa.

Foam Inhibitors

Spa water requires changing due to the buildup of soap in the water. Typically, soap will cause the spa water to foam when the jets are used. Soap is introduced into the spa water from two sources: users’ bodies, which retain a soap residue after showering, and swimming apparel, which retains soap after washing.

WATER QUALITY AND MAINTENANCE

Foam inhibitors can suppress foam, but cannot remove soap from the water. Soap is very difficult to remove from the water because soap is not oxidized by any chemical added to the spa. Only ozone can oxidize soap.

Eventually the soap build-up in the water will be concentrated, resulting in an unclean feeling on the bather's skin, which is impossible to remedy. When this occurs, it's time to drain and refill the spa. Depending on the soap input, the water should last about 4 months before needing to be drained.

MONARCH® OZONE SYSTEM

The Monarch high output ozone system is the only ozone purification system approved for installation in your Caldera® Spa. The Monarch ozone system utilizes Corona Discharge (CD) technology to produce a higher concentration of ozone than is produced by competing ultraviolet light (UV) ozone systems.



The Monarch high output ozone system unit offers less-visible installation and is less susceptible to the effects of freezing temperatures because it is mounted under the skirt. To access it for inspection, remove the equipment compartment door to check the unit operation (this is usually done prior to disconnecting the power to the spa before draining). Simply listen for the buzz of the transformer to verify operation of the Monarch high output ozone system.

The Monarch high output ozone system greatly enhances the quality of the spa water when used to supplement the spa owner's regular water maintenance program. Contrary to some information circulated throughout the pool and spa industry regarding ozone systems, ozone **CAN'T** be used as a single-source sanitizer, water clarifier, anti-foamer, and mineral chelating agent. Watkins® Manufacturing Corporation recommends that a chemical maintenance program based on recognized and documented industry standards still be followed when using an ozone purification system to assure water sanitation and the highest quality purified water.

Cleaning the Ozone Injector

On occasion, a mineral build up may clog the ozone injector, causing a lack of flow or low flow, of ozone bubbles. To prevent this, refer to the following instructions to clean the injector:

1. Disconnect power to the spa.
2. Access the equipment compartment.
3. Locate the ozonator in the equipment compartment and unplug the ozonator from the control box.
4. Place 16 ounces of white vinegar into a container such as a cup or bucket. Place the container on the equipment compartment floor. NOTE: White vinegar will not damage any of the spa components.
5. Carefully loosen the long tubing to the bottom of the ozonator. **A liquid substance may be found inside the tubing. If a liquid substance is present, BE CERTAIN NOT TO COME INTO CONTACT WITH THE LIQUID (SEE WARNING BELOW).**

 <p>WARNING</p>	<p><i>Nitric acid accumulates in the air lines of the ozonator and injector. Nitric acid will cause severe chemical burns if direct skin contact is made, so always wear protective gloves, glasses and clothing when working on the ozonator or injector lines. To prevent inhalation or ingestion of the nitric acid, DO NOT blow or inhale with your mouth to any of the adapters, fittings or tubing of the ozonator or injector air lines.</i></p>	 <p>WARNING</p>
---	---	---

6. Place the end of the tubing into the vinegar, making certain that the end of the tubing sits at the bottom of the container.
7. Reconnect power to the spa.
8. Run the spa until all 16 ounces of the vinegar are gone. This should allow an ample flow of vinegar to be run through the injector and clear the blockage.
9. Disconnect power to the spa.
10. Remove the empty cup or bucket.
11. Reinstall the tubing to the bottom of the ozonator.
12. Plug the ozonator into the control box.
13. Close the equipment compartment door.
14. Reconnect power to the spa.

The Monarch ozone system is practically maintenance-free because it is located within the spa's equipment compartment. If bubbles are appearing at the spa's heater return, but the water is not as clear as usual, then the operation of the ozone generator should be checked. Carefully open the equipment compartment door (remember to use care, as power is still connected to the spa) and verify that the CD tube and its transformer are energized (a slight buzz will be emitted from the ozone generator housing). If a slight buzz or hum is not audible, verify that the generator is completely plugged into the spa's control box.

If the unit is plugged in and power is connected to the spa, then the fuse (for the ozone generator) should be checked.

WARNING: Contact your Caldera® Spa Dealer if your spa requires troubleshooting beyond the scope of this manual. Monarch ozone systems should only be serviced by a qualified technician.

WARRANTY NOTE: Cleaning of the ozone injector is not covered under the warranty. Refer to the Ozone section of this manual for ozone injector cleaning instructions..

DOS AND DON'TS

- DON'T use swimming pool (muriatic) acid to lower pH.
- DON'T splash pH increaser additives on the siding.

WATER QUALITY AND MAINTENANCE

- DON'T misuse Compressed Sanitizers.

The use of bromine sticks or tablets in floaters, which may become entrapped in a lounge or cooling seat (or sink to the spa floor), have been shown to cause discoloration of or surface distress to a spa's shell.

- DON'T use a floater type sanitization system as a low or no maintenance solution to your spa maintenance program.

The spa shell can easily withstand the effects of a properly administered sanitizer. Floating dispensers can become trapped in one area and cause an over-sanitization (or chemical burn) of that particular area.

If the dispenser setting is too high, the high concentration can discolor the spa shell and damage the underside of the cover.

Automatic floating dispensers have a tendency to either over-brominate or under-brominate as the rate of erosion varies greatly. Damage to the spa and cover can occur very quickly.

IMPORTANT: Watkins® Manufacturing Corporation does not recommend the use of any floating chemical dispenser. Damage to the spa shell or components caused by a floating chemical dispenser is specifically not covered under the terms of the limited warranty.

- DON'T use a sanitizer which is not designed for spas.
- DON'T use household bleach (liquid sodium hypochlorite).
- DON'T broadcast or sprinkle the chemicals onto the water surface. This method may cause chemically-induced spa surface blistering (chemical abuse).
- DO add all chemicals slowly into or in front of the filter compartment with the jet pump operating for ten minutes.
- DO use special care if using baking soda to clean either the interior or exterior plastic surfaces.
- DO use only a granular form of sanitizer (chlorine).

COMMON WATER CHEMISTRY QUESTIONS

Question: Why is the use a floater not recommended to sanitize my spa water?

Answer: Watkins Manufacturing Corporation does not recommend the use of a floater for three reasons:

1. The floater is unable to control the rate at which the sanitizer is dissolved into the water. When a floater is first placed in a spa, the sanitizer level can be extremely high. High sanitizer levels can chemically burn or discolor the spa's shell or the underside of the cover. Then, after a period of time, the sanitizer level dispensed by the floater will fall to near zero. A low sanitizer level will allow viruses, bacteria or algae to grow.
2. Floaters tend to stay in one area of the spa most of the time, causing this area to be exposed to extreme sanitizer levels.
3. The floater may allow pieces of the highly concentrated sanitizer to fall out and settle on the floor or seat of the spa shell. These pieces of sanitizer will chemically burn (blister) the spa shell. Although your spa shell is specifically designed to resist the effects of spa chemicals, no spa surface can withstand this type of highly concentrated chemical. Remember, chemical abuse is specifically not covered under the terms of the warranty.

Question: When I open my spa, I smell chlorine. How do I get rid of this smell?

Answer: There are two types of chlorine in your spa. The first is the Free Available Chlorine, which is the chlorine available to sanitize your spa. This free Available Chlorine does not have an odor. The second is Chloramine, which is residue from chlorine already expended. Chloramines have a strong chlorine odor. The smell from Chloramines can be eliminated by "shocking" the water. If you smell chlorine in the water, your spa is reminding you to add a shock treatment.

Question: Why can't I fill my spa with soft water?

Answer: Soft water is essentially the same as regular water except that most or all of the calcium has been replaced by sodium. Soft water may be corrosive to the heater and other components. Replacement of spa components damaged by soft water is extremely expensive.

Question: I am trying to reduce the number of chemicals to which my family is exposed. Do I really need to use so many chemicals and in such large amounts?

Answer: While over-exposure to any chemical can be unhealthful, many low levels of chemicals are effective and beneficial. In the case of spa water, the chemicals recommended in the Caldera® Spa Water Maintenance program are needed to protect the user from water-borne pathogens (disease-causing microbes) and to prevent corrosion of spa components.

Question: Why isn't water chemistry damage covered by the warranty?

Answer: The chemical levels and water quality of the water in the spa are under your direct control. With proper basic care, the spa will provide many years of hot water relaxation. If you are unsure about any chemical or its usage in the spa, contact your Authorized Caldera Dealer or Watkins Manufacturing Corporation.

WATER TERMINOLOGY

The following chemical terms are used in this Water Quality and Maintenance section. Understanding their meaning will help you to better understand the water maintenance process.

Bromamines: Compounds formed when bromine combines with nitrogen from body oils, urine, perspiration, etc. Unlike chloramines, bromamines have no pungent odor and are effective sanitizers.

Bromine: A halogen sanitizer (in the same chemical family as chlorine). Bromine is commonly used in stick, tablet, or granular form. See the DO's and DON'Ts of Spa Water Maintenance for additional information.

Calcium Hardness: The amount of dissolved calcium in the spa water. This should be approximately 150-200 ppm. High levels of calcium can cause cloudy water and scaling. Low levels can cause harm to the spa equipment.

Chloramines: Compounds formed when chlorine combines with nitrogen from body oils, urine, perspiration, etc. Chloramines can cause eye irritation as well as having a strong odor. Unlike bromamines, chloramines are weaker, slower sanitizers.

Chlorine: An efficient sanitizing chemical for spas. Watkins® Manufacturing Corporation recommends the use of sodium dichlor-type granulated chlorine. This type is

WATER QUALITY AND MAINTENANCE

preferred because it is totally soluble and nearly pH neutral.

Chlorine (or Bromine) Residual: The amount of chlorine or bromine remaining after chlorine or bromine demand has been satisfied. The residual is, therefore, the amount of sanitizer which is chemically available to kill bacteria, viruses and algae.

Corrosion: The gradual wearing away of metal spa parts, usually caused by chemical action. Generally, corrosion is caused by low pH or by water with levels of TA, CH, pH or sanitizer which are outside the recommended ranges.

DPD: The preferred reagent used in test kits to measure the Free Available Chlorine.

Halogen: Any one of these five elements: fluorine, chlorine, bromine, iodine, and astatine.

MPS: Monopersulfate is a non-chlorine oxidizer.

Oxidizer: The use of an oxidizing chemical is to prevent the buildup of contaminants, maximize sanitizer efficiency, minimize combined chlorine and improve water clarity.

Ozone: Ozone is a powerful oxidizing agent which is produced in nature and artificially by man. Ozone forms no byproducts of chloramines (ozone actually oxidizes chloramines) and will not alter the water's pH.

Pathogen: A microorganism such as bacterium that cause disease.

pH: The measure of the spa water's acidity and alkalinity. The recommended pH for the spa water is 7.4 to 7.6. Below 7.0 (considered neutral), the spa water is too acidic and can damage the heating system. Above 7.8, the water is too alkaline and can result in cloudy water, and scale formation on the shell and heater.

ppm: The abbreviation of "parts per million", the standard measurement of chemical concentration in water. Identical to mg/l (milligrams per liter).

Reagent: A chemical material in liquid, powder, or tablet form for use in chemical testing.

Sanitizer: Sanitizers are added and maintained at recommended residuals to protect bathers against pathogenic organisms which can cause disease and infection in spa water.

Scale: Rough calcium-bearing deposits that can coat spa surfaces, heaters, plumbing lines and clog filters. Generally, scaling is caused by mineral content combined with high pH. Additionally, scale forms more readily at higher water temperatures.

Shock Treatment: Also known as "super-chlorination" when chlorine is used. Shock treatment is a process of adding significant doses of a quick dissolving sanitizer (sodium dichlor is recommended) to oxidize non-filterable organic waste and to remove chloramines and bromamines.

Total Alkalinity: The amount of bicarbonates, carbonates, and hydroxides present in spa water. Proper total alkalinity is important for pH control. If the TA is too high, the pH is difficult to adjust. If the TA is too low, the pH will be difficult to hold at the proper level. The desired range of TA in spa water is 125 to 150 ppm.

SPA WATER MAINTENANCE TROUBLESHOOTING GUIDE		
Problem	Probable causes	Solutions
Cloudy Water	<ul style="list-style-type: none"> • Dirty filter • Excessive oils / organic matter • Improper sanitization • Suspended particles / organic matter • Overused or old water 	<ul style="list-style-type: none"> • Clean filter • Shock spa with sanitizer • Add sanitizer • Adjust pH and/or alkalinity to recommended range • Run jet pump(s) and clean filter • Drain and refill the spa
Water Odor	<ul style="list-style-type: none"> • Excessive organics in water • Improper sanitization • Low pH 	<ul style="list-style-type: none"> • Shock spa with sanitizer • Add sanitizer • Adjust pH to recommended range
Chlorine Odor	<ul style="list-style-type: none"> • Chloramine level too high • Low pH 	<ul style="list-style-type: none"> • Shock spa with sanitizer • Adjust pH to recommended range
Musty Odor	<ul style="list-style-type: none"> • Bacteria or algae growth 	<ul style="list-style-type: none"> • Shock spa with sanitizer – if problem is visible or persistent, drain, clean and refill the spa
Organic buildup / scum ring around spa	<ul style="list-style-type: none"> • Buildup of oils and dirt 	<ul style="list-style-type: none"> • Wipe off scum with clean rag – if severe, drain the spa, use a spa surface and tile cleaner to remove the scum and refill the spa
Algae Growth	<ul style="list-style-type: none"> • High pH • Low sanitizer level 	<ul style="list-style-type: none"> • Shock spa with sanitizer and adjust pH • Shock spa with sanitizer and maintain sanitizer level
Eye Irritation	<ul style="list-style-type: none"> • Low pH • Low sanitizer level 	<ul style="list-style-type: none"> • Adjust pH • Shock spa with sanitizer and maintain sanitizer level
Skin Irritation / Rash	<ul style="list-style-type: none"> • Unsanitary water • Free chlorine level above 5 ppm 	<ul style="list-style-type: none"> • Shock spa with sanitizer and maintain sanitizer level • Allow free chlorine level to drop below 5 ppm before spa use
Stains	<ul style="list-style-type: none"> • Total alkalinity and/or pH too low • High iron or copper in source water 	<ul style="list-style-type: none"> • Adjust total alkalinity and/or pH • Use a stain and scale inhibitor
Scale	<ul style="list-style-type: none"> • High calcium content in water – total alkalinity and pH too high 	<ul style="list-style-type: none"> • Adjust total alkalinity and pH – if scale requires removal, drain the spa, scrub off the scale, refill the spa and balance the water

SERVICE

MISCELLANEOUS SERVICE INFORMATION

The control and high limit thermostats are equipped with electronic sensors that are connected to the spa's plumbing. Never cut, or kink the wires that connect the sensors to the thermostats within the control box.

The jet pump is equipped with a thermal overload cutoff switch that is designed to protect the pump from overheating. If the pump shuts itself off in an older spa, it could indicate failure of the pump motor bearings. If the pump shuts itself off in a new spa, it is usually the result of one or a combination of the following factors:

- **Thermal Overload:** Although mass-produced, not all thermal overload cutoffs are exactly the same. Some are more sensitive than others and will shut the pump off at lower temperatures.
- **High Temperature:** All Caldera® spa models are equipped with a jet pump shroud that vents the heat generated by the pump motor to the outside of the equipment compartment. If the vent is blocked by masonry, grass, or debris, overheating of the jet pump may occur. Once the pump motor has cooled sufficiently and any blockage has been removed from the vent opening, the jet pump can be restarted.
- **Friction:** Sometimes the moving parts of a new pump are tight enough to cause heat buildup due to friction. After a normal break-in period, the pump will run cooler.
- **Improper Wiring:** If the spa is connected with an extension cord, and/or the house wiring is undersized, the pump may starve for voltage and therefore may draw more amperage and generate excessive heat.
- If the pump is shutting down due to excessive heat, make sure the equipment compartment has adequate ventilation. The air gap at the bottom must not be blocked. Should your jet pump continue to shut off after short periods of use, contact a qualified service technician.

ACTS INVALIDATING WARRANTY

The limited warranty is void if the Caldera spa has been improperly installed, subjected to alteration, misuse, or abuse, or if any repairs on the spa are attempted by anyone other than an authorized representative of Watkins® Manufacturing Corporation. Alteration shall include any component or plumbing change, electrical conversion, or the addition of any non-approved sanitation or water purification device or heating system which contributes to component or unit failure or unsafe operating system. Misuse and abuse shall include any operation of the spa other than in accordance with Watkins Manufacturing Corporation printed instructions, or use of the spa in an application for which it is not designed; specifically: use of the spa in a non-residential application; damage caused by operation* of the spa at water temperatures outside the range of 35°F and 120 °F; damage caused by a dirty, clogged or calcified filter cartridge; damage to the spa surface caused by the use of tri-chloro chlorine, BCDMH, misuse of chemical tablets in a floater, acid, or any other spa chemicals or spa surface cleaners which are not recommended by Watkins Manufacturing Corporation; damage caused by allowing undissolved spa sanitizing chemicals to lie on the spa surface (no spa surface material can withstand this kind of abuse); damage to components or spa surface caused by improper water chemistry maintenance; and damage to the spa surface caused by leaving the spa uncovered while empty of water and in direct exposure to sunlight (this may cause solar heating distress in warm weather regions). These are considered abuses and may invalidate this warranty.

*Operation of the spa does not mean "use" of the spa! Watkins Manufacturing Corporation does not recommend using the spa if the water temperature is above or below the spa's control panel temperature range.

DISCLAIMERS

Watkins Manufacturing Corporation shall not be liable for loss of use of the Caldera spa, or other incidental, consequential, special, indirect, or punitive costs, expenses or damages, which may include but are not limited to the removal of a permanent deck or other custom fixture, or the necessity for crane removal. Any implied warranty shall have a duration equal to the duration of the applicable limited warranty stated above. Some states do not allow limitations on how long an implied warranty lasts. Under no circumstances shall Watkins Manufacturing Corporation or any of its representatives be held liable for injury to any person or damage to any property, however arising.

Some states do not allow the exclusion or limitation of incidental or consequential damages, so the above limitations may not apply to you.

WATKINS CUSTOMER SERVICE

If you have any questions about any aspect of your Caldera spa set-up, operation, or maintenance that have not been answered by this manual, consult your Caldera dealer.

Watkins Manufacturing Corporation can be reached at: 800-669-1881 (Extension 432), Monday through Friday, 8 am to 5 pm Pacific Standard Time (PST), or e-mail custsvc@watkinsmfg.com

SPA TROUBLESHOOTING

If your spa doesn't seem to be working the way you believe it should, please review the "start-up" and "operation" instructions in this manual. If this doesn't help you correct the problem, follow the appropriate instructions below. If the problem still is not resolved, call your Caldera® dealer.

GENERAL OPERATION TROUBLESHOOTING GUIDE

Problem	Probable causes	Solutions
Entire spa is inoperative	<ul style="list-style-type: none"> Power failure GFCI tripped Heater high limited thermostat tripped Spa Lock activated 	<ul style="list-style-type: none"> Check power source Reset GFCI; call for service if it will not reset. Disconnect power for at least thirty seconds to reset heater high limit. If it will not reset, check for clogged filters. If tripping continues, call for service. Deactivate spa lock
Jets weak or surging	<ul style="list-style-type: none"> Spa water level too low Filter clogged Air valves are closed 	<ul style="list-style-type: none"> Add water Clean filter Open air valves
All lights inoperative	<ul style="list-style-type: none"> Spa lock activated Light wiring to control box faulty or interface is faulty 	<ul style="list-style-type: none"> Deactivate spa lock Call for service
Single light inoperative	<ul style="list-style-type: none"> Light wiring faulty Main light assembly is faulty Light wiring not attached to fiber optic harness 	<ul style="list-style-type: none"> Call for service Remove panel, reattach the LED light to the fiber optic harness
Flashing "TEMP" on main control panel	<ul style="list-style-type: none"> Dirty Filter Low water level Pressure switch problem Temperature sensor problem 	<ul style="list-style-type: none"> Clean filter See Start Up Section In Owner's Manual Disconnect power for at least thirty seconds. If flashing continues after power up, call for service
Four flashing lines on the main control panel	<ul style="list-style-type: none"> Heater high limit thermostat tripped 	<ul style="list-style-type: none"> Disconnect power for at least thirty seconds to reset heater high limit. If it will not reset, check for clogged filter. If tripping continues, call for service
Spa not heating properly	<ul style="list-style-type: none"> Temperature set too low Spa cover improperly positioned Dirty Filter Summer Timer On 	<ul style="list-style-type: none"> Set control panel to a higher temperature. Align spa cover Clean filter Turn summer timer mode to off position
Pump motor will not function	<ul style="list-style-type: none"> Motor overload condition Control switch failure if jet symbol does not come on. 	<ul style="list-style-type: none"> Let cool for one hour. Motor overload will reset automatically. If Problem persists, contact your Caldera dealer Disconnect spa and contact your Caldera dealer
Noisy pump or motor	<ul style="list-style-type: none"> Low water level 	<ul style="list-style-type: none"> Add water to normal level (1 inch above highest jet)
Pump motor runs, but low or no water/jet pressure	<ul style="list-style-type: none"> Air control valve closed or blocked Low water level Dirty filter cartridge Jet blocked Clogged suction or skimmer basket 	<ul style="list-style-type: none"> Open or clean air valve Add water to normal level (1 inch above highest jet) Clean filter cartridge Remove jet face eyeball and clean orifice Clean suction cover or skimmer basket
Diverter valves are difficult to turn	<ul style="list-style-type: none"> Sand or grit inside valves 	<ul style="list-style-type: none"> Clean and lubricate valve per diverter valve maintenance instructions

Priming the pumps: Upon filling or refilling the spa, if a pump is operating and water is not flowing from any of its jets, the pump may not be properly primed. To correct, perform the following procedures:

- Turn off power to the spa at the breaker and remove the equipment compartment doors.
- Loosen the union on the top of the pump to allow the air to escape. When water is present, hand-tighten the union.
- Turn power back on, activate the pump and check to make sure union is tight enough to keep it from leaking.

NOTES

UTOPIA & AQUATIC MELODIES® SERIES SPECIFICATIONS

	Footprint dimensions	Height	Effective filter area	Heater (Watts)	Water capacity	Dry weight	Filled weight*	Dead weight*	Electrical Requirements
Utopia Geneva™	7'5" x 7'5"	38"	100 Square feet (15")	4,300	475 Gallons	920 Lbs.	5,915 Lbs.	115 Lbs. per square foot	230 volt, 30 or 50 amp Single phase GFCI protected circuit
Utopia Niagara®	7'5" x 7'5"	38"	100 Square feet (15")	4,300	500 Gallons	920 Lbs.	6,300 Lbs.	115 Lbs. per square foot	230 volt, 30 or 50 amp Single phase GFCI protected circuit
Utopia Tahitian®	7'0" x 7'0"	36"	100 Square feet (15")	4,300	360 Gallons	790 Lbs.	4,825 Lbs.	105 Lbs. per square foot	230 volt, 30 or 50 amp Single phase GFCI protected circuit
Aquatic Melodies® Elation®	7'7" x 7'7"	38"	100 Square feet (15")	4,300	500 Gallons	930 Lbs.	6,135 Lbs.	115 Lbs. per square foot	230 volt, 30 or 50 amp Single phase GFCI protected circuit
Aquatic Melodies Aspire™	7'0" x 7'0"	36"	100 Square feet (15")	4,300	380 Gallons	800 Lbs.	5,180 Lbs.	110 Lbs. per square foot	230 volt, 30 or 50 amp Single phase GFCI protected circuit

CAUTION: Watkins® Manufacturing Corporation suggests a structural engineer or contractor be consulted before the spa is placed on an elevated deck.

* NOTE: The "Filled weight" and "Dead weight" of the spa includes the weight of the occupants (assuming an average occupant weight of 175 lbs).

This manual contains installation, operating, maintenance, and service information for the following Caldera® spa models:

MODELS	EFFECTIVE DATE
GENEVA	12/04
NIAGARA	12/04
TAHITIAN	12/04
ELATION	12/04
ASPIRE	12/04



©2005 Watkins Manufacturing Corporation. Caldera Spas, Monarch, Advent, EnergyPro, SpaGlo, Pure Comfort, Geneva, Niagara, Tahitian, Elation, Aspire, Acquarella, EcoTech, Ecsta Seat, Euro-Pulse, VersaSsage, OrbiSsage, LumbarSsage, Sole Soothers, Euphoria, Atlas, Aquatic Melodies and The Home Relaxation Specialists are trademarks of Watkins Manufacturing Corporation. Baqua Spa is a trademark of AVECIA, Inc. Magna and MagnaSsage are trademarks of Hydro Air-ITT Industries. Windex® is a trademark of S.C. Johnson & Son, Inc. Soft Scrub® is a trademark of The Clorox Company.



Watkins Manufacturing Corporation
Vista, California
USA