

**LED Series Hot Tub Owner's Manual  
J-315, J-325, J-335, J-345 Models**

6530-377, Rev. A

**230 VAC, 3-Wire Connection**

USE COPPER CONDUCTORS ONLY. WIRE SIZE MUST BE APPROPRIATE PER NEC AND/OR LOCAL CODES.

# Attention New Spa Owner!

Congratulations on the purchase of your new Jacuzzi® spa! The following is a list of automated functions performed by your spa. These functions are listed below in an attempt to suppress any operational concerns you may have during the first 24-hours of ownership! Also listed below are important maintenance recommendations you should observe on a regular basis to protect your new investment.

## Automated Operations

Approximately two minutes after power is applied to the spa, the first skimming/heating cycle turns on pump 1. In J-335 and J-345 models, an automatic five minute “blow-out” function also activates pump 2 for a period of five minutes to flush all lines. Then, after five minutes, pump 2 turns off and pump 1 continues to operate for the duration of the cycle. *Note: this function only occurs during the first filtration/heating cycle each day.*

## Maintain Healthy Spa Water

Always maintain your spa’s water chemistry within the following parameters as defined by the Association of Pool And Spa Professionals/USA:

pH	7.2 - 7.4
Free Chlorine	3-5 ppm
Free Bromine	4-6 ppm
Total Alkalinity	100-120 ppm
Calcium Hardness	150-250 ppm

Always maintain your spas filter as outlined below to ensure healthy spa water. Refer to page 33 “Water Quality Maintenance” for additional information.

## Required Filter Maintenance

Your new spa is equipped with an advanced water filtration system that provides unsurpassed water quality! To ensure maximum water quality at all times, you should clean the filter cartridge every three months, or earlier as necessary. See page 27-29 for detailed filter cartridge cleaning/replacement instructions.

## Required Water Replacement

You should replace the spa’s water every 3 months. The frequency depends on a number of variables including frequency of use, number of users, and attention paid to water quality maintenance. You will know it is time for a change when you cannot control sudsing and/or you can no longer get the normal feel or sparkle to the water, even though the key water balance measurements are all within the proper parameters. See page 33 for additional information.

# Table of Contents

<b>1.0</b>	<b>Important Spa Owner Information</b> .....	<b>1</b>
<b>2.0</b>	<b>Important Safety Instructions</b> .....	<b>2</b>
<b>3.0</b>	<b>Choosing A Location</b> .....	<b>7</b>
3.1	Outdoor Location .....	7
3.2	Indoor Location .....	8
<b>4.0</b>	<b>General Electrical Safety Instructions</b> .....	<b>8</b>
<b>5.0</b>	<b>Power Requirements</b> .....	<b>9</b>
<b>6.0</b>	<b>Electrical Wiring Instructions</b> .....	<b>11</b>
<b>7.0</b>	<b>Spa Fill Up Procedure</b> .....	<b>13</b>
<b>8.0</b>	<b>Control Functions</b> .....	<b>18</b>
8.1	Control Panel .....	18
8.2	Spa Features And Controls.....	19
8.3	Jet/Air Controls Diagram (J-315 & J-325).....	20
8.4	Jet/Air Controls Diagram (J-335 & J-345).....	21
<b>9.0</b>	<b>Operating Instructions</b> .....	<b>22</b>
9.1	Setting Water Temperature .....	22
9.2	Activate Pumps .....	22
9.3	Light Button.....	22
9.4	Selecting Desired Massage Action .....	23
9.5	Adjusting Individual Jet Flow .....	23
9.6	Adjusting PowerPro Jets.....	23
9.7	Waterfall Feature .....	24
9.8	Air Controls .....	24
9.9	Optional Jacuzzi Audio System .....	24
<b>10.0</b>	<b>Automatic Filtration Cycles</b> .....	<b>25</b>
10.1	Standard Skimming/Heating Modes .....	25
10.2	Economy Skimming/Heating Modes .....	25
10.3	Lock Modes.....	25
10.4	Selecting The Skimmer/Heating Mode .....	26
<b>11.0</b>	<b>Spa Maintenance</b> .....	<b>27</b>
11.1	Cleaning The Filters.....	27
11.2	Draining And Refilling .....	29
11.3	Cleaning The Spa Interior.....	30
11.4	Pillow Care.....	31
11.5	Maintaining The Cover.....	31
11.6	Maintaining The Synthetic Cabinet.....	31

11.7	Winterizing .....	32
11.8	Restarting Your Spa in Cold Weather.....	33
<b>12.0</b>	<b>Water Quality Maintenance .....</b>	<b>33</b>
12.1	pH Control.....	33
12.2	Sanitizing .....	34
12.3	Optional CD Ozone Water Maintenance System .....	34
<b>13.0</b>	<b>Error Conditions/Error Messages .....</b>	<b>34</b>
13.1	Summer Logic.....	34
13.2	Overheat Condition.....	35
13.3	Panel Displays (SN1).....	35
13.4	Panel Displays (SN2).....	35
13.5	Panel Displays (FL1 or FL2).....	35
13.6	Panel Displays (COL) .....	36
13.7	Panel Displays (ICE).....	36
13.8	Panel Displays (- - -).....	36
<b>14.0</b>	<b>Troubleshooting Procedures .....</b>	<b>36</b>
14.1	None Of The Components Operate.....	37
14.2	Pump Does Not Operate but Light Does.....	37
14.3	Poor Jet Action.....	37
14.4	Water Is Too Hot .....	38
14.5	No Heat.....	38
<b>15.0</b>	<b>J-315 Convertible Circuit Diagram (60Hz) .....</b>	<b>39</b>
<b>16.0</b>	<b>J-325/J-335/J-345 Circuit Diagram (60Hz).....</b>	<b>40</b>
<b>17.0</b>	<b>J-315 Export Circuit Diagram (50Hz) .....</b>	<b>41</b>
<b>18.0</b>	<b>J-325/J-335/J-345 Export Circuit Diagram (50Hz) .....</b>	<b>42</b>
<b>19.0</b>	<b>Optional Stereo Receiver Functions.....</b>	<b>43</b>



## 1.0 Important Spa Owner Information

Your Jacuzzi® spa is constructed to the highest standards and is capable of providing many years of trouble-free use. However, because heat retentive materials are utilized to insulate the spa for efficient operation, an uncovered spa surface directly exposed to sunlight and high temperatures for an extended period is subject to permanent damage. Damage caused by exposing the spa to this abuse is not covered by warranty. We recommend that you always keep the spa full of water when it is exposed to direct sunlight and that you keep the Jacuzzi insulating cover in place at all times when the spa is not in use. Read and carefully follow the requirements for your spa's support base found in the section 3.0 titled, "Choosing A Location" (page 7) or as prescribed by your authorized Jacuzzi dealer.

**Jacuzzi spas constantly strives to offer the finest spas available, therefore, modifications and enhancements may be made which affect the specifications, illustrations and/or instructions contained herein.**

### FCC Notice

This equipment has been tested and found to comply with the limits for a Class B Digital Device, pursuant to Part 15 of the FCC Rules. These limits are designed to provide reasonable protection against harmful interference in a residential installation. This equipment generates, uses and can radiate radio frequency energy and, if not installed and used in accordance with the instructions, may cause harmful interference to radio communications. However, there is no guarantee that interference will not occur in a particular installation. If this equipment does cause harmful interference to radio or television reception, which can be determined by turning the equipment off and on, the user is encouraged to try to correct the interference by one or more of the following measures:

1. Rearrange or relocate the receiving antenna;
2. Increase the separation between the equipment and receiver;
3. Connect the equipment into an outlet on a circuit different from the circuit connected;
4. Consult the dealer or an experienced radio/TV technician for help. (Changes or modifications not expressly approved by the party responsible for FCC compliance could void the user's authority to operate this equipment.)



## 2.0 IMPORTANT SAFETY INSTRUCTIONS

### READ AND FOLLOW ALL INSTRUCTIONS CAREFULLY

When installing and using this electrical equipment, basic safety precautions should always be followed, including:

1. **WARNING:** To reduce the risk of injury, do not permit children to use this product unless they are closely supervised at all times.
2. **WARNING:** A grounding wire connector is provided on this unit to connect a minimum No. 8 AWG (8.4mm<sup>2</sup>) solid copper conductor between this unit and any metal equipment, metal enclosures of electrical equipment, metal water pipe, or conduit within 5 feet (1.5m) of the unit.
3. **DANGER:** Risk of Accidental Drowning. Extreme caution must be exercised to prevent unauthorized access by children. To avoid accidents, ensure that children cannot use this spa unless they are supervised at all times.
4. **DANGER:** Risk of Injury. The suction fittings in this spa are sized to match the specific water flow created by the pump. Should the need arise to replace the suction fittings or the pump, be sure that the flow rates are compatible. Never operate the spa if the suction fittings are broken or missing. Never replace a suction fitting with one rated less than the flow rate marked on the original suction fitting.
5. **DANGER:** Risk of Electric Shock. Install at least 5 feet (1.5m), from all metal surfaces. As an alternative, a spa may be installed within 5 feet of metal surfaces if each metal surface is permanently connected (bonded) by a minimum No. 8 AWG (8.4 mm<sup>2</sup>) solid copper conductor attached to the wire connector on the grounding lug, inside the equipment compartment on the equipment box.
6. **DANGER:** Risk of Electric Shock. Do not permit any electrical appliance, such as a light, telephone, radio, television, etc. within 5 feet (1.5m) of a spa unless such appliances are built-in by the manufacturer.
7. **ELECTRICAL SUPPLY:** The electrical supply for this product must include a suitably rated switch or circuit breaker to open all ungrounded supply conductors to comply with section 422-20 of the



National Electrical Code/USA, ANSI/NFPA 70. The disconnect must be readily accessible and visible to the spa occupant but installed at least 5 feet (1.5m), from the spa water.

**8. WARNING: To Reduce the Risk of Injury:**

9. The water in the spa should never exceed 104°F (40°C). Water temperatures between 100°F (38°C) and 104°F (40°C) are considered safe for a healthy adult. Lower water temperatures are recommended for young children and when spa use may exceed 10 minutes.
10. Since excessive water temperatures have a high potential for causing fetal damage during the early months of pregnancy, pregnant or possibly pregnant women should limit spa water temperatures to 100°F (38°C). If pregnant, please consult your physician before using a spa.
11. Before entering the spa, the user should measure the water temperature with an accurate thermometer since the tolerance of water temperature-regulating devices may vary as much as +/- 5°F (2°C).
12. The use of alcohol, drugs, or medication before or during spa use may lead to unconsciousness with the possibility of drowning.
13. Persons suffering from obesity or a medical history of heart disease, low or high blood pressure, circulatory system problems, diabetes, infectious diseases or immune deficiency syndromes should consult a physician before using a spa. If you experience breathing difficulties in association with using or operating your spa, discontinue use and consult your physician.
14. Persons using medication should consult a physician before using a spa since some medication may induce drowsiness, while other medication may affect heart rate, blood pressure, and circulation.
15. Always shower before and after using your spa. To reduce the possibility of contracting a waterborne illness, always maintain water chemistry within the parameters listed on the inside cover of this manual. If you or other bathers experience such a condition, discontinue use and seek medical attention.

**IMPORTANT CSA SAFETY INSTRUCTIONS (CANADA ONLY)**

When using this electrical equipment, basic safety precautions should always be followed, including the following:

1. READ AND FOLLOW ALL INSTRUCTIONS.
2. A green colored terminal or a terminal marked G, Gr, Ground, Grounding or the ⊕ symbol\* is located inside the supply terminal box or compartment. To reduce the risk of electric shock, this terminal must be connected to the grounding means provided in the electric supply service panel with a continuous copper wire equivalent in size to the circuit conductors that supply this equipment.

\*IEC Publication 417, Symbol 5019.

3. At least two lugs marked “Bonding Lugs” are provided on the external surface or on the inside of the supply terminal box/compartment. To reduce the risk of electric shock, connect the local common bonding grid in the area of the spa to these terminals with an insulated or bare copper conductor not smaller than No. 6 AWG.
4. All field installed metal components such as rails, ladders, drains or other similar hardware within 10 feet (3m) of the spa shall be bonded to the equipment grounding buss with copper conductors not smaller than No. 6 AWG.

**5. SAVE THESE INSTRUCTIONS.**

**WARNING:** Children should not use spas without adult supervision.

**WARNING:** Do not use spas unless all suction guards are installed to prevent body and hair entrapment.

**WARNING:** People with infectious diseases should not use a spa.

**WARNING:** To avoid injury, exercise care when entering or exiting the spa.

**WARNING:** Do not use drugs or alcohol before or during the use of a spa to avoid unconsciousness and possible drowning.

**WARNING:** Pregnant or possibly pregnant women should consult a physician before using a spa.





**WARNING:** Water temperature in excess of 40°C (104°F) may be injurious to your health.

**WARNING:** Before entering the spa, measure the water temperature with an accurate thermometer.

**WARNING:** Do not use a spa immediately following strenuous exercise.

**WARNING:** Prolonged immersion in a spa may be injurious to your health.

**WARNING:** Do not permit electric appliances (such as lights, telephone, radio, television, etc.) within 5 feet (1.5m) of this spa unless such appliances are built-in by the manufacturer.

**CAUTION:** Maintain water chemistry in accordance with manufacturer's instructions.

**WARNING:** The use of alcohol or drugs can greatly increase the risk of fatal hyperthermia in spas.

## **SAVE THESE INSTRUCTIONS**

### **HYPERTHERMIA**

Prolonged immersion in hot water may induce hyperthermia. A description of the causes, symptoms, and effects of hyperthermia are as follows:

Hyperthermia occurs when the internal temperature of the body reaches a level several degrees above the normal body temperature of 98.6°F (37°C). The symptoms of hyperthermia include drowsiness, lethargy, and an increase in the internal temperature of the body. The effects of hyperthermia include:

1. Unawareness of impending hazard;
2. Failure to perceive heat;
3. Failure to recognize the need to exit spa;
4. Physical inability to exit spa;
5. Fetal damage in pregnant women; and
6. Unconsciousness and danger of drowning.



**A warning sign is provided in your warranty packet. Please install it at a location near your spa, where it is visible to the user of the spa. For additional or replacement signs please contact your local Jacuzzi dealer and reference item number #6530-082.**

## **CAUTIONS**

1. Persons suffering from heart disease, diabetes, high or low blood pressure, and any condition requiring medical treatment, pregnant women, the elderly, or infants should consult with a physician before using a spa.
2. The Consumer Products Safety Commission/USA has stated that the water temperature in a spa should not exceed 104°F (40°C). Immersion in water in excess of 104°F (40°C) can be hazardous to your health.
3. Observe a reasonable time limit when using the spa. Long exposures at higher temperatures can cause high body temperature. Symptoms may include dizziness, nausea, fainting, drowsiness, and reduced awareness. These effects could possibly result in drowning.
4. Do not use the spa under the influence of alcohol, narcotics, or other drugs. Use of the spa under these conditions may lead to serious consequences.
5. Always test the spa water temperature before entering the spa. Enter and exit the spa slowly. Wet surfaces can be very slippery.
6. Never bring any electrical appliances into or near the spa. Never operate any electrical appliances from inside the spa or when you are wet unless such appliances are built-in by the manufacturer.
7. Proper chemical maintenance of spa water is necessary to maintain safe water and prevent possible damage to spa components.
8. Use the straps and clip tie downs to secure the cover when not in use. This will help to discourage unsupervised children from entering the spa and keep the spa cover secure in high-wind conditions. There is no representation that the cover, clip tie-downs, or actual locks will prevent access to the spa.



### 3.0 Choosing A Location

**IMPORTANT:** Because of the combined weight of the spa, water and users, it is extremely important that the base upon which the spa rests be smooth, flat, level and capable of uniformly supporting this weight, without shifting or settling, for the entire time the spa is in place. If the spa is placed on a surface which does not meet these requirements, damage to the skirt and/or the spa shell may result. Damage caused by improper support is not covered under the manufacturers warranty. It is the responsibility of the spa owner to assure the integrity of the support over time.

We recommend a poured, reinforced concrete slab with a minimum thickness of 4 inches (10cm). Wood decking is also acceptable provided it is constructed so that it meets the requirements outlined above. The spa must be installed in such a manner as to provide drainage away from the spa. Placing the spa in a depression without provisions for proper drainage could allow rain, overflow and other casual water to flood the equipment and create a wet condition in which it would sit.

For spas which will be recessed into a floor or deck, install so as to permit access to the equipment, either from above or below, for servicing. Make certain that there are no obstructions which would prevent removal of the cabinet side panels and access to the jets components, especially on the side with the equipment bay doors.

#### 3.1 Outdoor Location

In selecting the ideal outdoor location for your spa, we suggest that you take into consideration:

1. The proximity to changing area and shelter (especially in colder weather).
2. The pathway to and from your spa (this should be free of debris so that dirt and leaves are not easily tracked into the spa).
3. The closeness to trees and shrubbery (remember that leaves and birds could create extra work in keeping the spa clean).
4. A sheltered environment (less wind and weather exposure can result in lowered operation and maintenance costs).
5. The overall enhancement of your environment. It is preferable not to place the spa under an unguttered roof overhang since run-off water will shorten the life expectancy of the spa cover.



### 3.2 Indoor Location

For indoor installations, be certain to make provisions for proper ventilation. When the spa is in use, considerable amounts of moisture will escape. This can damage certain surfaces over time. If you have any questions regarding the placement or installation of your spa, consult your authorized Jacuzzi dealer.



**WARNING: In addition to maintenance of filters and water chemistry, proper ventilation is recommended to reduce the risk of exposure to viruses and bacteria that could be present in the air or water. Consult a licensed architect or building contractor to determine your specific needs if installing your spa indoors.**

### 4.0 General Electrical Safety Instructions

Your new Jacuzzi® spa is equipped with a “state-of-the-art” equipment system. It contains the most advanced safety and self-protective equipment in the industry. Nonetheless, this spa must be installed properly to insure dependable usage. Please contact your dealer or local building department should you have any questions regarding your installation.

Proper grounding is extremely important. Jacuzzi spas are equipped with a current collector system. A pressure wire connector is provided on the surface of the control box, located outside the equipment door (Figure-B, page 12) to permit connection of a bonding wire between this point and any ground metal equipment, metal water pipe or conduit within 5 feet (1.5m) of the spa, or copper clad grounding rod buried within 5 feet (1.5m) of the spa. Bonding wire must be at least No. 8 AWG (8.4mm<sup>2</sup>) solid copper wire. This is a most important safety assurance feature. Before installing this spa, check with the local building department to insure installation conforms to local building codes.

#### 120/240 Volt J-315 Convertible Models

A spa connected to a 120 VAC electrical service must be located close enough to a grounded, grounding-type electrical outlet so that the included power cord can be plugged directly into it. **DO NOT USE AN EXTENSION CORD** as this could cause damage to the spa's equipment due to insufficient voltage. The power supplied to this spa must be a dedicated circuit with no other appliances or lights sharing the power provided by the circuit.



### 5.0 Power Requirements

Jacuzzi® spas are designed to provide optimum performance and flexibility of use when connected to the maximum electrical service listed in the tables below. If you prefer, your dealer can perform a minor circuit board modification to allow your spa to accept an electrical service other than the factory setting. The operational considerations of these modifications are listed in the footnotes below.

#### US / Canada J-315 1-Pump Convertible Models (60Hz)

	<u>120V/15A*</u>	<u>240V/30A*</u>	<u>240V/40A**</u>
Voltage:	120 VAC	240 VAC	240 VAC
# of Wires:	3 (15A GFCI Cord, US Only)	4	4
Frequency:	60Hz	60Hz	60Hz
Current Draw:	12A	21A	30A
Circuit Breaker:	15A, 1-Pole	30A, 2-Pole	40A, 2-Pole

**For 240 VAC Heater Operation:** Move the red wire on the main terminal strip (TB1) from position #1 to position #3. Make certain wires are connected exactly as shown in Figure-D (page 13) before applying power. Failure to do so will result in damage to the circuit board and/or related components and void the manufacturer’s warranty.

\* In the 15A and 30A configuration, the heater **will not operate** at the same time as the high-speed jets pump. **The factory setting is 120V/15A.** **Note: All Canadian spas must be hard wired (120 VAC or 240 VAC) per CSA Canadian standards see page 4 for details.**

\*\* If the spa is to be operated on 40A service, remove the jumper JP1 #1-2 on the circuit board to allow the heater to operate at the same time as the high-speed jets pump (Page 39).

#### US / Canada J-325 1-Pump Models (60Hz)

	<u>240V/50A*</u>	<u>240V/40A**</u>
Voltage:	240 VAC	240 VAC
# of Wires:	3	3
Frequency:	60Hz	60Hz
Current Draw:	36A	26A
Circuit Breaker:	50A, 2-Pole	40A, 2-Pole

\* In the 50A configuration, the heater **will operate** at the same time as the high-speed jets pump. **This is the factory setting.**

\*\* In the 40A configuration, the heater **will not operate** at the same time as the high-speed jets pump.



## US / Canada J-335 / J-345 2-Pump Models (60Hz)

	<u>240V/50A*</u>	<u>240V/40A**</u>	<u>240V/60A***</u>
Voltage:	240 VAC	240 VAC	240 VAC
# of Wires:	3	3	3
Frequency:	60Hz	60Hz	60Hz
Current Draw:	36A	26A	45A
Circuit Breaker:	50A, 2-Pole	40A, 2-Pole	60A, 2-Pole

- \* In 50A configuration, the heater **will not operate** while both jets pumps are running in high speed. *Note: pump 2 runs only in high speed. **This is the factory setting.***
- \*\* In 40A configuration, the heater **will not operate** while either jets pump is running in high speed. *Note: pump 2 runs only in high speed.*
- \*\*\* In 60A configuration, the heater **will operate** while both jets pumps are running in high speed. *Note: pump 2 runs only in high speed.*

## Export J-315 / J-325 1-Pump Models (50Hz)

	<u>230V/20A*</u>	<u>230V/30A**</u>
Voltage:	230 VAC	230 VAC
# of Wires:	3	3
Frequency:	50Hz	50Hz
Current Draw:	15A	23A
Circuit Breaker:	20A	30A

- \* In 20A configuration, the heater **will not operate** at the same time as the main jets pump. ***This is the factory setting.***
- \*\* In 30A configuration, the heater **will not operate** at the same time as the main jets pump.

## Export J-335 / J-345 2-Pump Models (50Hz)

	<u>230V/20A*</u>	<u>230V/30A**</u>	<u>230V/40A***</u>
Voltage:	230 VAC	230 VAC	230 VAC
# of Wires:	3	3	3
Frequency:	50Hz	50Hz	50Hz
Current Draw:	15A	23A	29A
Circuit Breaker:	20A	30A	40A

- \* In 20A configuration, the heater **will not operate** while either jets pump is running in high speed. ***This is the factory setting.***  
*Note: jets pump 2 runs only in high speed.*
- \*\* In 30A configuration, the heater **will not operate** while both jets pumps are running in high speed. *Note: pump 2 runs only in high speed.*
- \*\*\* In 40A configuration, the heater **will operate** while either jets pump is running in high speed. *Note: Jets pump 2 runs only in high speed.*



## 6.0 Electrical Wiring Instructions



**IMPORTANT NOTICE:** The electrical wiring of this spa must meet the requirements of the National Electrical Code/USA (NEC) and any applicable state or local codes. The electrical circuit must be installed by a qualified electrician and approved by a local building/electrical inspection authority.

1. **Convertible J-315 120/240V 60Hz Power Models**
- A. **120V “Plug-in” Operation:** This spa must operate on the supplied 120V GFCI cord at its original length or must be hard-wired for longer runs. **Never use an extension cord for any reason!**
- B. **Convertible 120/240V Operation:** The included 120V GFCI cord must be discarded for 240V operation. This spa must be hard-wired. Supplying power to either configuration above which is not in accordance with these instructions will void both the independent testing agency listing and the manufacturer’s warranty.
2. **Dedicated 230-240V Power Models:** This spa must be permanently connected (hard-wired) to the power supply. **No plug-in connections or extension cords are to be used in conjunction with the operation of this spa.** Supplying power to the spa which is not in accordance with these instructions will void both the independent testing agency listing and the manufacturer’s warranty.
3. The power supplied to this spa *must* be a *dedicated* circuit with no other appliances or lights sharing the power provided by the circuit.
4. To determine the current, voltage and wire size required, refer to section 5.0 “Power Requirements” (page 9-10).
  - Wire size must be appropriate per NEC/USA and/or local codes.
  - We recommend type THHN wire.
  - All wiring must be copper to ensure proper connections. **Do not use aluminum wire.**
  - When using wire larger than #6 (10mm<sup>2</sup>), add a junction box near the spa and reduce to short lengths of #6 (10mm<sup>2</sup>) wire to connect to the spa.
5. The electrical supply for this product must include a suitably rated switch or circuit breaker to open all ungrounded supply conductors to comply with Section 422-20 of the National Electrical Code/USA, ANSI/NFPA 70. The disconnecting means must be readily accessible to the spa’s occupant but installed at least 5 feet (1.5m) from spa water.
6. The electrical circuit supplied for the spa must include a suitable ground fault circuit interrupter (GFCI) as required by NEC/USA Article 680-42.



7. To gain access to the spa's power terminal block, remove the screws securing the cabinet panel on the side of the spa under the controls. Then remove the four control box door screws and door (Figure-B).
8. Select the power supply inlet you want to use (Figure-A). Feed power cable to control box, then install it through the large opening provided in the bottom side of the box.
9. Connect wires, color to color, on terminal blocks TB1 and TB3 (Figure C-F, page 13). TIGHTEN SECURELY! All wires must be hooked up securely or damage could result.
10. Install control box door and screws and reinstall the cabinet side panels.

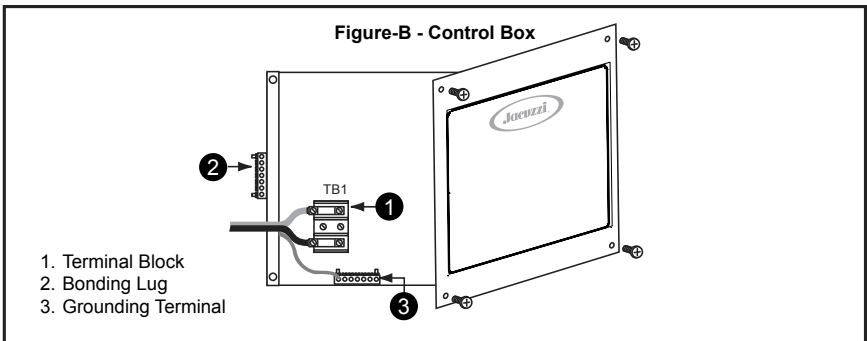
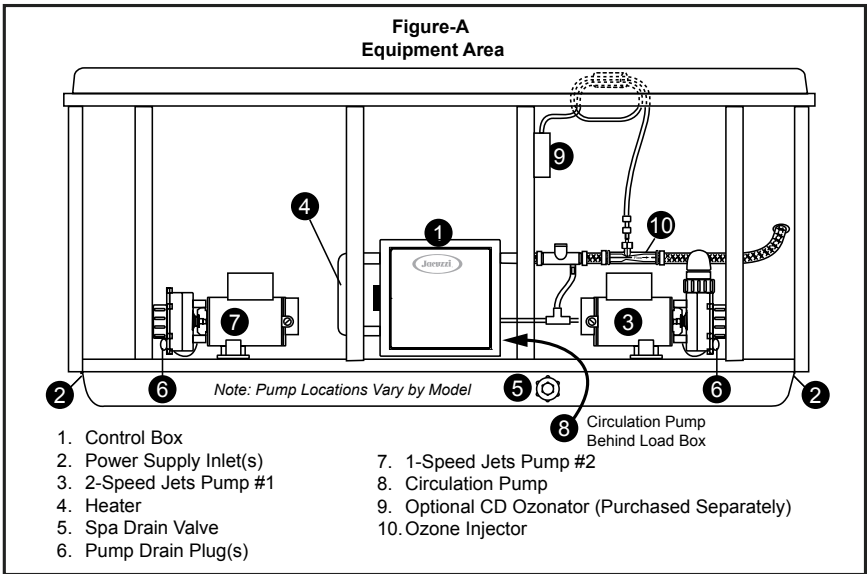



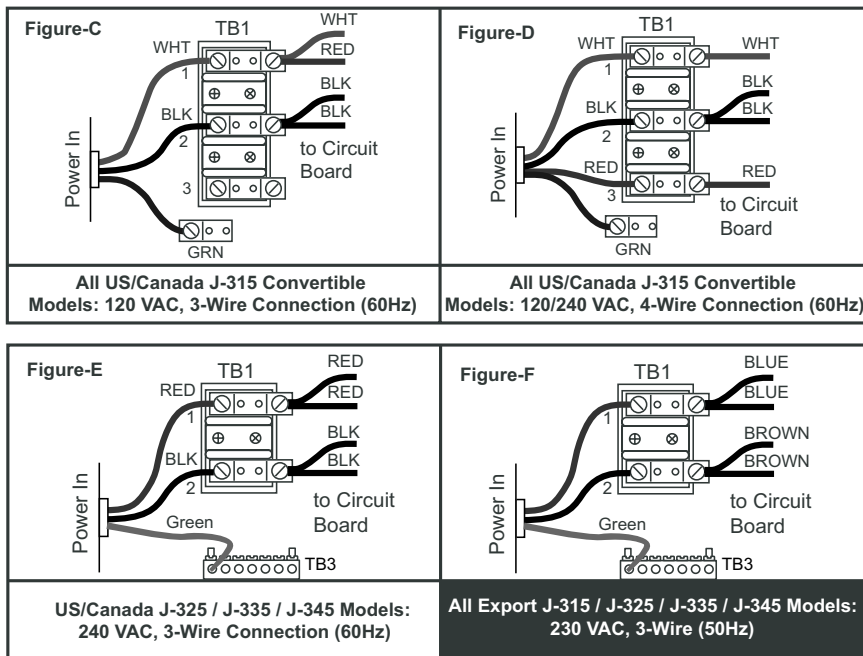

## 7.0 Spa Fill Up Procedure

FOR BEST RESULTS, read each step in its entirety before proceeding with that step:

### 1. Prepare The Spa For Filling

- Clear all debris from the spa. (Although the spa shell has been polished at the factory, you may want to treat it with a specially formulated spa cleaner. Consult your authorized Jacuzzi dealer for additional information prior to filling spa.
- Remove filter lid then remove filter cartridges from filter bucket.

### 2. Fill Spa

- Place the end of your garden hose into the empty filter bucket.



**CAUTION:** Never fill with water from a water softener. If your water is extremely “hard”, it is preferable to fill half-way with hard water and the rest of the way with softened water. Or, you may fill entirely with hard water if you use a special water additive available from your authorized Jacuzzi dealer.



- Fill spa until water covers all jets but does not touch the bottom of the lowest headrest. DO NOT OVERFILL.

**IMPORTANT:** Always fill your spa through the filter bucket after draining. Failure to do so may cause air to be trapped in either pump, preventing the pump from circulating water. Remove the hose and replace both filter cartridges.

### 3. Turn On Power

Turn on power to spa at the home's circuit breaker. The heater and filter/circulation pump will automatically activate. If the control panel LCD flashes water temperature and "COL" or "ICE", refer to page 36 for additional information.

### 4. Activate Jets Pump 1

Depress the JETS 1 button on the control panel once to activate jets pump #1.



### 5. Add Start-Up Chemicals

Add the spa water chemicals as recommended by your authorized Jacuzzi dealer. See section 12.0 "Water Quality Maintenance" (page 33) for general guidance.

### 6. Establish A Stable Sanitizer Reading

Establish a stable sanitizer reading between 3 ppm and 5 ppm. To ensure healthy water conditions, always maintain a constant sanitizer reading within the levels recommended by the Association of Pool And Spa Professionals/USA printed on the inside cover of this manual. If sanitizer levels cannot be stabilized, perform the decontamination procedure steps 9-15 on page 15-17. *Note: the "decontamination procedure" steps 9-15 should also be used after the spa has been "Winterized" (section 11.7, page 32) or has been sitting without power for an extended period.*

### 7. Set Spa To Heat

To warm spa water to a comfortable temperature, follow these steps:

- The LCD display on the control panel displays the actual temperature of the spa water. Press either the **COOLER (-)** or **WARMER (+)** button once to display the "set" temperature for 5 seconds. If you want the water to heat to a different temperature,



simply press **COOLER (-)** or **WARMER (+)** within 5 seconds. The set temperature increases or decreases by one degree each time one of these buttons is pressed.

- The heater will turn off when the temperature corresponding to the thermostat setting is achieved.

### Important Heater Details:

- The maximum temperature for which the spa can be set is 104°F (40°C) and the minimum is 80°F (27°C).
- Setting the thermostat at maximum will not accelerate the heating process. This will only result in a higher ultimate temperature.
- The heater operates until the water reaches the programmed “set temperature”, then turns off. The heater will reactivate after the water cools to approximately 1.5° below the “set temperature.”

### 8. Place Cover On Spa

- Keeping the insulating cover in place anytime the spa is not in use will reduce the time required for heating, thereby minimizing operating costs.
- The time required for initial heat-up will vary depending on the starting water temperature.



**DANGER:** Risk of injury, always check water temperature carefully before entering spa!

### Decontamination Procedure (Steps 9-15)

Steps 9-15 below are only required when sanitizer levels are unstable after performing steps 1-6 above. Disregard steps 9-15 below if sanitizer levels remain stable at 3 ppm to 5 ppm after performing steps 1-6.

9. Add 2.5 ounces of sodium dichlor for every 100 gallons of water. Refer to the table on page 16 for approximate water fill volume by model.



**CAUTION:** Never add chlorine tablets (trichlor) to your spa for any reason! This chemical may damage your spa and void the manufacturer warranty.



## Water Fill Volume by Model

Spa Model	Approximate Fill Volume
J315.....	200 US Gallons (757 Liters)
J325.....	320 US Gallons (1,211 Liters)
J335.....	358 US Gallons (1,355 Liters)
J345.....	336 US Gallons (1,272 Liters)

10. Leave spa cover open during this step to allow excessive chemical vapors to exit spa, protecting pillows and plastic knobs from chemical attack. If spa is indoors, open doors and windows for proper ventilation. Turn on all spa jets pumps for one hour, open all air controls, and place all massage selector knob(s) in their center “combo” position as shown (right). *Note: You will need to press the jets pump button(s) every 20 minutes since these functions have an automatic 20 minute time-out function that turns them off.*



**CAUTION:** never leave your spa unattended for any reason while the cover is open and accessible to small children and animals!

11. Turn off power to the spa at the circuit breaker, then drain tub as outlined in section 11.2 “Draining And Refilling” (page 29-30).
12. Fill spa until water covers all jets but does not touch the bottom of the lowest headrest. DO NOT OVERFILL.



**CAUTION:** Never fill with water from a water softener. If your water is extremely “hard”, it is preferable to fill half-way with hard water and the rest of the way with softened water. Or, you may fill entirely with hard water if you use a special water additive available from your authorized Jacuzzi dealer.

13. Consult your authorized Jacuzzi dealer for chemical recommendations, then add chemicals to spa water to achieve a constant sanitizer reading within the levels recommended by the Association of Pool And Spa Professionals/USA printed on the inside cover of this manual.
14. Turn on all jet(s) pumps when adding chemicals to ensure proper mixing and leave your spa cover open until the sanitizer level falls below 5 ppm to protect pillows and plastic knobs from chemical attack.



**CAUTION:** Never leave your spa unattended for any reason while the cover is open and accessible to small children and animals.



**CAUTION:** To prevent the unlikely possibility of contracting a waterborne illness, maintain water chemistry within step 6 parameters. If you or other bathers experience such a condition, discontinue use and seek medical attention.

15. Establish a sanitizer reading between 3 ppm and 5 ppm, then allow the spa to set undisturbed for 8 hours. Retest water after 8 hours to determine if sanitizer levels are stable. If sanitizer levels are stable, your spa is ready for use. To ensure healthy water conditions, always maintain a constant sanitizer reading within the levels recommended by the Association of Pool And Spa Professionals/USA printed on the inside cover of this manual. If sanitizer levels are not stable at this time, it will be necessary to repeat this procedure in its entirety (steps 1-15) until stable sanitizer readings are achieved.



## 8.0 Control Functions

### 8.1 Control Panel

- A. **LED Display:** Can display current water temperature (default display), water temperature set point, selected skimming/heating mode, and error messages.

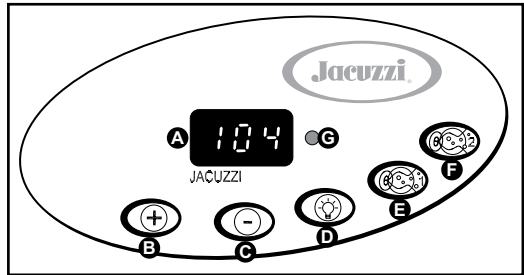

*2 Pump Control Panel Shown*

- B. **Warmer ( + ) Button:** Increases water temperature set point.
- C. **Cooler ( - ) Button:** Decreases water temperature set point.
- D. **Light Button:** Controls Spa Light See Section 9.3, page 22
- E. **Jets 1 Button:** Turns jets pump #1 on and off. Press once for low speed; press a second time for high speed; press a third time to turn pump off.
- F. **Jets 2 Button:** turns high-speed jets pump #2 on and off. Press once to turn on; press a second time to turn pump off (2-pump models only).
- G. **Heat Indicator:** Lit when heater is on.

### Operation Details

- **Temperature Adjustment:** 65 to 104°F (18 to 40°C). Factory default setting is 100°F (38°C).
- **Underwater Light Operation:** Light runs for 1 hour then shuts off.
- **Jets 1/Jets 2 Button Operation:** Jets run for 20 minutes after activated, then turn off automatically to conserve energy. Simply press either jets button to continue operation for an additional 20 minutes.



## 8.2 Spa Features And Controls

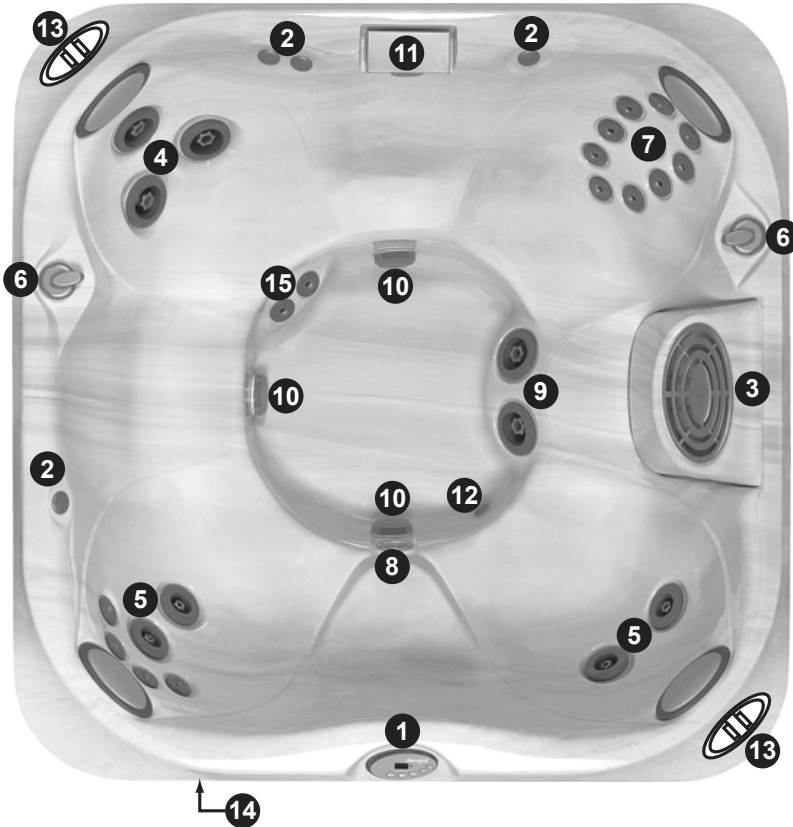

*J-345 model illustrated - Location of Features Varies by Model*

- |                                            |                                                               |
|--------------------------------------------|---------------------------------------------------------------|
| 1. Control Panel                           | 11. Waterfall Feature                                         |
| 2. Push Button Air Controls                | 12. Heater Return Fitting                                     |
| 3. Filter/Skimmer Grill                    | 13. Optional Audio System Speakers (J-335/J-345 Models Only). |
| 4. PowerPro MX Jets                        | 14. Optional Audio System Receiver (J-335/J-345 Models Only)  |
| 5. Therapy Jets                            | 15. Calf Jets                                                 |
| 6. Diverter Valve                          |                                                               |
| 7. Therapy Seat                            |                                                               |
| 8. Spa Light                               |                                                               |
| 9. Vertical Jets (Foot Jets)               |                                                               |
| 10. Footwell Suction Fittings and Filters. |                                                               |



### 8.3 Jet/Air Controls Diagram (J-315 & J-325 Models)

#### J-315

**Massage Selector Operation**  
Rotate Massage Selector 1 to Divert Water Between Jet Groups A-B.

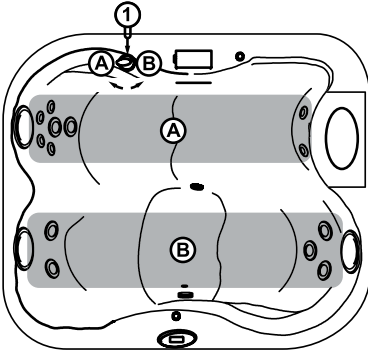

Massage Selector #1 Controls the Main Pump's Water Flow.

**Air Control Operation**  
Depress Air Controls A or B to Open or Close Air Inlet to Designated Jet Groups.

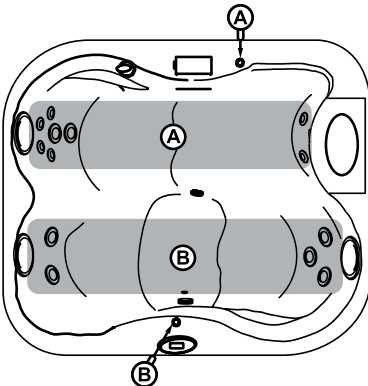

#### J-325

**Massage Selector Operation**  
Rotate Massage Selector 1 to Divert Water Between Jet Groups A or B&C.

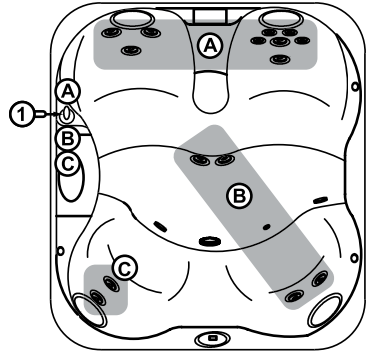

Massage Selector #1 Controls the Main Pump's Water Flow.

**Air Control Operation**  
Depress Air Controls A-C to Open or Close Air Inlet to Designated Jet Groups.

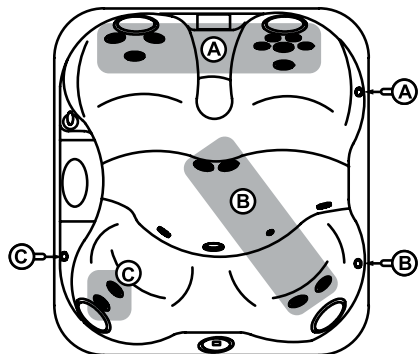



## 8.4 Jet/Air Controls Diagram (J-335 & J-345 Models)

### J-335

**Massage Selector Operation**  
Rotate Massage Selector 1 to  
Divert Water Between  
Jet Groups A&B

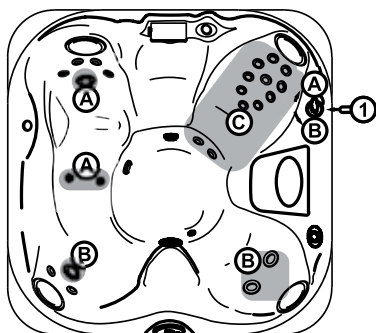

Massage Selector #1 Controls  
Pump 1. Seat C Powered by Pump 2.  
Unmarked Jets Are Always On When  
Pump 1 is Running.

### J-345

**Massage Selector Operation**  
Rotate Massage Selector 1 to  
Divert Water Between Jet  
Groups A-B.

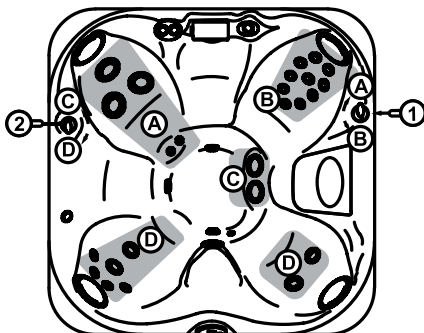

Massage Selector #1 Controls  
Pump 1. Seat Jets D And  
Footwell Jets C Are Powered  
by Pump 2.

### Air Control Operation

Depress Air Controls A-C to  
Open or Close Air Inlet to  
Designated Jet Groups.

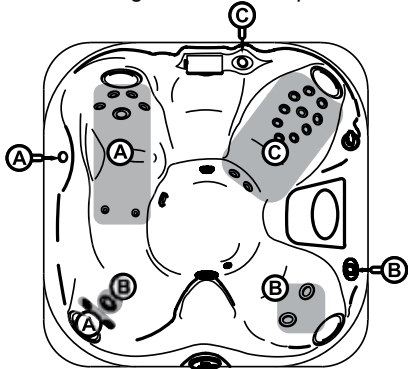

### Air Control Operation

Depress Air Controls A-D to  
Open or Close Air Inlet to  
Designated Jet Groups.

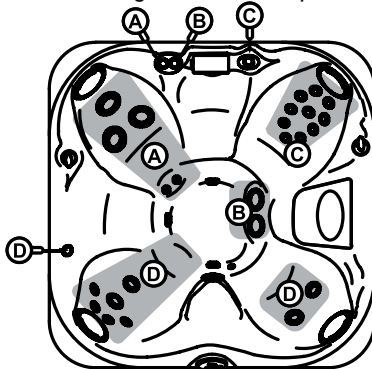



## 9.0 Operating Instructions

The spa control system has automatic functions that operate upon start-up and normal operation to protect the system. Upon power up, the readout displays the following information:



1. Control panel displays current software release (e.g. 3.56), then;
2. Control panel displays “888” and all indicator LEDs are lit, permitting visual inspection of all display segments and indicator lights for proper operation.
3. After the initial start-up sequence ends, the actual water temperature is displayed. If water temperature at this time is less than the factory default temperature setting of 100°F (38°C) and the spa is set to either standard skimming/heating mode “F0-F3”, the heater will turn on and run until the water temperature rises to the factory setting, then turn off. *Note: it is common for the heater to turn on after the spa is first filled because tap water is often very cold.*

### 9.1 Setting Water Temperature

The spa’s thermostat provides optimum control of water temperature. The temperature set point (set temperature) can be adjusted from 65°F to 104°F (18°C to 40°C). To raise the set temperature, press the **WARMER ( + )** button. To lower the set temperature, press the **COOLER ( - )** button. *Note: The first press of either **WARMER ( + )** or **COOLER ( - )** button displays the set temperature.*



### 9.2 Activate Pumps

The **JETS 1** button activates the functions of the main 2-speed jets pump. The first press activates jets pump 1 in low speed, the second press activates high speed, and the third press shuts the pump off. The **JETS 2** button controls jets pump 2 which operates only in high speed. Both jets pumps have a twenty-minute default when manually activated.



### 9.3 Light Button

The spa light offers 6 constant color variations & unique random mode for enhanced spa enjoyment. Press **LIGHT** button once to turn on spa light in “Random” mode, then repeatedly press light button to turn the light off, or to select one of 6 constant colors illustrated on the following page.



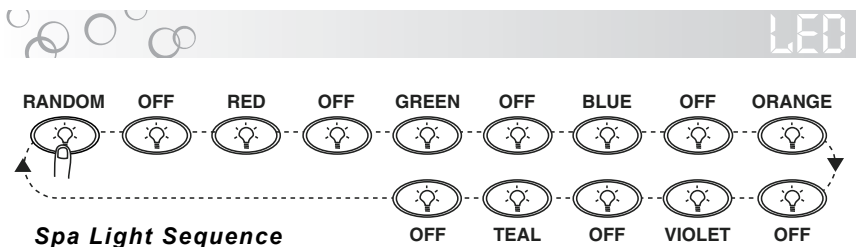

You must press the **LIGHT** button within 5 seconds between each “off” or “color” step in the light sequence to prevent it from resetting. Pressing the button after 5 seconds restarts the sequence in “Random” mode. This mode automatically changes the light color every 8 to 20 seconds. *Note: Any time the spa light is manually turned on, it will automatically turn off after approximately 1 hour. If you desire more light at this time, simply turn the light back on.*

### 9.4 Selecting Desired Massage Action

Your Jacuzzi® spa is equipped to allow you to customize the massage action you desire. Each model incorporates a massage selector that allows you to customize the massage and performance by diverting water between various jet systems. Simply turn massage selector to position A (Combo), B, or C to divert water pressure to various jet groups.

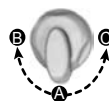

**Note:** This valve is intended to operate in positions A (Combo), B, and C for optimum performance. It is considered normal for sound levels within the valve to vary between positions due to the large amounts of water flowing through it! For optimum filtration benefits, leave the valve in position A when spa is covered. Select position B or C for maximum jet performance during spa use.

### 9.5 Adjusting Individual Jet Flow

The water flow to the individual jets in your spa can be increased or decreased by rotating the outside jet face. *Note: Always keep at least 6 adjustable jets open at all times.*



### 9.6 Adjusting PowerPro Jets

With the nozzles of the PowerPro Jets positioned straight ahead, the jet stream will be stationary. Pushing the nozzle to one side causes the jet nozzle to rotate, moving the jet stream in a circular pattern. **The jets may not spin with Jets pump 1 on low speed.**





### 9.7 Waterfall Feature

The waterfall feature allows you to independently control it for a customized soothing effect. The **JETS 1** button activates the waterfall feature. The waterfall is individually adjusted moving the control lever next to it forward or backwards. To turn on, move lever inward. To turn off, move lever outward. *Note: The operation of the waterfall light feature is covered in section 9.3, (page 22-23.)*

### 9.8 Air Controls

Certain jet systems have their own “push-button” air control. Each control introduces air into the water lines that supply that specific jet group. Simply press any air control button (once) to open; then press a second time to close. To minimize heat loss, all air controls should be closed when the spa is not in use.



### 9.9 Optional Audio System (J-335 & J-345 Models Only)

Spas equipped with the optional Jacuzzi stereo system offer enhanced spa enjoyment. These models include an integrated AM/FM/CD receiver with two high-quality marine speakers for unsurpassed sound quality and long-life. Both speakers located on spa corners (page 19), are designed for manual extension and retraction.



To expose each speaker for audio, simply press its release button to unlatch the “pop-up” mechanism. To retract each speaker before covering spa, gently press downward on each speaker enclosure until you feel a slight “click”, then release. Refer to section 19.0, (page 43) for complete stereo details.



**CAUTION:** Never step or sit on a speaker enclosure! This type of misuse will damage the speaker enclosure latching and track mechanism. Always retract speakers prior to covering spa. Misuse of the spa is not covered under the limited warranty.



## 10.0 Automatic Filtration Cycles

Your new spa includes a 24-hour circulation pump which filters the water continuously. The circulation pump draws water through the skimmer bag and one of two filter cartridges to effectively remove small debris in your spa. *Note: the 24-hour circulation pump system also supplies heated water to the spa when the heater turns on. This feature cannot be altered or disabled.*

The control system activates a programmable “standard” or “economy” skimming/heating cycle to remove larger debris missed by the 24-hour circulation pump filtration system. These cycles utilize pump #1 and the filter cartridge to quickly clear “skim” the water of large debris and minimize their “bath-tub ring” effect. Apart from their skimming benefit, each mode also effects the operation of your spa’s heater. Refer to sections 10.1 and 10.2 below for additional information.

### 10.1 Standard Skimming/Heating Modes (F0 - F3)

Standard skimming/heating modes are typically selected by customers in cold climates where heat up times are extended due to lower ambient temperatures. In these modes, the water temperature is regulated by the set temperature, 24-hour circulation pump, and heater which turns on as needed. After the programmed set temperature is reached, the heater turns off and the circulation pump continues to operate 24-hours to filter and clean your spa.

### 10.2 Economy Skimming/Heating Modes (F4 - F6)

Economy skimming/heating modes are typically selected by customers in warm climates where heat up times are minimized due to higher ambient temperatures. In these modes, the water temperature is regulated by the set temperature, 24-hour circulation pump, and heater only while a programmed filter cycle is running (unless in summer logic; see section 13.1, page 34). *Note: these modes consume less energy than standard modes F0-F3 outlined above.*

### 10.3 Lock Modes (L1 - L2)

These modes are designed for use during spa service or to prevent unauthorized use.



#### 10.4 Selecting The Skimmer/Heating Mode

Press and hold both control panel **WARMER ( + )** and **COOLER ( - )** buttons **at the same time**, then release. Then press either **WARMER ( + )** or **COOLER ( - )** button to select skimming/heater mode F0-F6 or lock modes L1-L2 below.

##### Standard Skimming/Heating Modes

- F0** 5 minutes of skimming per day (one 5 minute “Blow-Out” cycle every 24 hours to purge all plumbing lines)
- F1** 1 hour of skimming per day (one 30-minute cycle every 12 hours); this is the factory default setting.
- F2** 1.5 hours of skimming per day (one 30-minute cycle every 8 hours)
- F3** 2 hours of skimming per day (one 30-minute cycle every 6 hours)



##### Economy Skimming/Heating Modes

- F4** 1 hour of skimming/heating per day (one 30-minute cycle every twelve hours)
- F5** 1.5 hours of skimming/heating per day (one 30-minute cycle every eight hours)
- F6** 2 hours of skimming/heating per day (one 30-minute cycle every six hours)



##### Lock Modes

- L1** Lock Out (disables all spa functions to permit filter cleaning)
- L2** Lock Mode (disables the jets and light buttons to prevent unauthorized use of spa.) Skimming/heater cycle will continue to operate as programmed in this mode. The temperature display flashes when this function is enabled.



**Example:** the “F3” skimming/heater cycle was enabled prior to choosing lock mode. The spa continues to perform the “F3” cycle until lock mode is canceled, allowing another cycle to be selected.

To set a time for the first skimmer/heating cycle, simply turn power on to the spa two minutes prior to the desired time. **EXAMPLE:** If you desire your first skimming/heater cycle to begin at 10:00 AM turn off power to the spa and turn it back on again at 9:58 AM.

*Note: start time is approximate and may vary slightly from day to day.*



## 11.0 Spa Maintenance

Proper and regular maintenance of your spa will help it retain its beauty and performance. Your authorized Jacuzzi dealer can supply you with all the information, supplies, and accessory products you will need to accomplish this.

### 11.1 Cleaning The Filters

Your Jacuzzi spa is equipped with a skimmer bag and two high performance filter cartridges located inside the filter skimmer. Fine debris are filtered by the circulation pump drawing water through the skimmer bag and circulation pump cartridge. Larger debris are filtered by the 2-speed jets pump #1 drawing water through the skimmer bag and main pump cartridge during normal operation and at each skimming/heating cycle. The skimmer bag and filter cartridges provide unsurpassed water quality by trapping surface and suspended particles.

An optional chemical feeder is available through your authorized Jacuzzi dealer that installs under the filter cap (#2472-673). Always remove the chemical feeder cap and feeder (when used) during the filter cleaning process by turning the cap handle counterclockwise. Reinstall the cap and feeder back onto the filter cartridge after the filter cleaning process is complete. To avoid touching the chemical feeder, it is recommended that latex gloves be used during this process. **Note: when used, the chemical feeder MUST remain on the circulation pump filter cartridge! This filter cartridge is the one with the grid across the wall fitting as shown (right).**

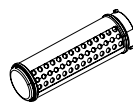

The J-335 and J-345 models include filters on their footwell suction covers that prevent debris from entering pump #2, when operating. These filters must remain in place to protect pump #2's plumbing network. They should be cleaned every 2 months, or when weak pump #2 performance is observed. To ensure optimum performance, clean and reuse both main filter cartridges once a month.

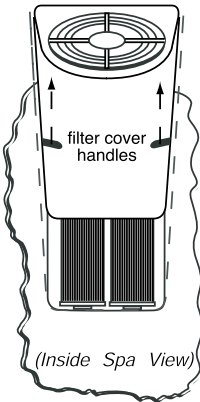

**ALWAYS TURN POWER TO SPA OFF BEFORE CLEANING THE FILTER CARTRIDGES!** Refer to the filter cleaning/replacement procedure on the following page:

**A****TURN POWER TO SPA OFF!****B**

Lift upward on filter cover handles to unsnap and remove it from mating retainer clips.

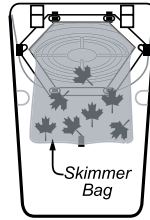
**C**

Remove skimmer bag from clips, clean out, then reinstall onto filter cover.

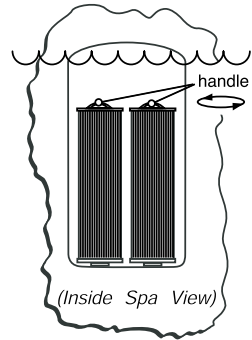
**D**

Rotate each filter cartridge handle counterclockwise to unthread from mating wall fitting.

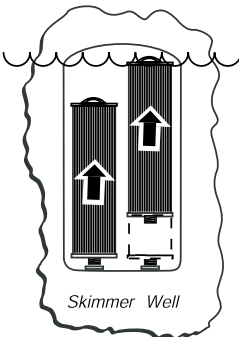
**E**

Remove both filter cartridges from skimmer well.

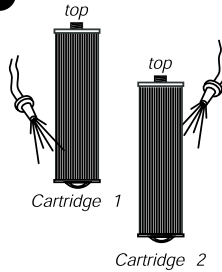
**F**

If used, remove the chemical feeder as instructed prior to rinsing the filter cartridges. Rinse debris from filter pleats on each cartridge using a garden hose and high-pressure nozzle. Start at the top and work downward to the handle. Repeat until all pleats are clean.

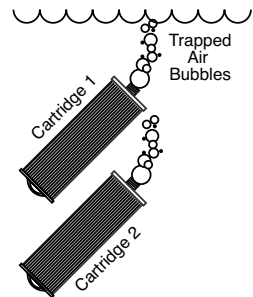
**G**

Submerge both filter cartridges in spa. Tilt threaded end upward to remove trapped air bubbles from each cartridge, then keep both cartridges submerged for step H.





**H**

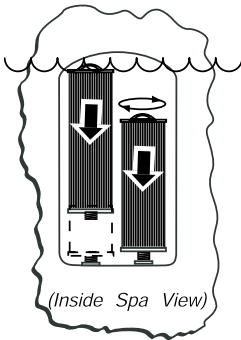

Place each cartridge back into skimmer well\*, then rotate each cartridge handle clockwise to thread back into wall fitting. **DO NOT OVERTIGHTEN!**

**I**

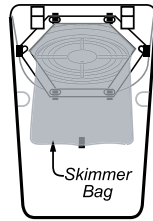

(Filter Cover Back View)

Install clean skimmer bag back onto clips as shown.

**J**

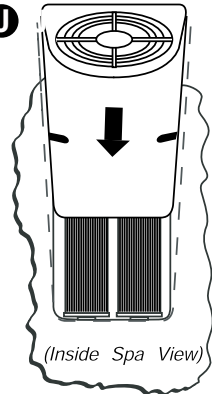

1. Install filter cover with skimmer bag by sliding it down into position over mating spa retainer clips.
2. Turn power to spa back on.

**\*Note: when replacing the filter cartridges, the chemical feeder must remain on the circulation pump inlet. The circulation pump inlet will have a grid across the wall fitting.**



Periodically, both filter cartridges will need a more thorough cleaning to remove imbedded oils and minerals. For this, we suggest cleaning as illustrated in step "F", followed by soaking the filter overnight in a plastic container filled with a solution of water and specially formulated filter cleanser available from your authorized Jacuzzi dealer. The chemical feeder should be removed during this process. The average life expectancy of each filter is approximately two years with proper care and water quality maintenance. Replacement cartridges may be purchased from your Jacuzzi dealer.

### 11.2 Draining And Refilling

About every 3 months, you will want to replace the spa's water. The frequency depends on a number of variables including the amount of use, attention paid to water quality maintenance, etc. You will know it is time for a change when you cannot control sudsing and/or you can no longer get the normal feel or sparkle to the water even though the key water balance measurements are all within the proper parameters.



**WARNING! READ THIS BEFORE DRAINING:** To prevent damage to the spa's components, **turn off power to the spa at the circuit breaker before draining it.** Do not turn the power back on until your spa has been refilled.



**CAUTION:** There are certain precautions to keep in mind when draining your spa. If it is extremely cold, and the spa is outdoors, freezing could occur in the lines or the equipment (see "WINTERIZING", page 32.) On the other hand, if it is hot outdoors, do not leave the spa's surface exposed to direct sunlight.

To drain your spa, perform the following steps:

1. Turn off power to spa at breaker.
2. Locate the drain valve on the front/lower plastic pan. Hold the larger (rear) body to prevent it from turning, then loosen and remove the front cap to expose the underlying male hose threads.
3. Attach a garden hose to the exposed threads.
4. Gently rotate the larger (rear) valve body 1/3 turn counterclockwise to unlock the drain valve.
5. Pull the larger (rear) body outward to open drain.
6. After the spa drains, perform steps 2-5 in reverse order to close the drain prior to refilling the spa.

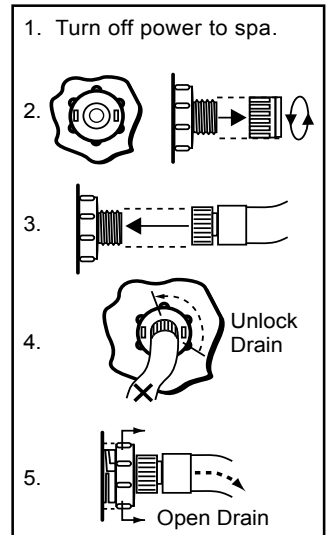

**After refilling, turn on power to the spa and follow the steps listed under "Spa Fill Up Procedure." (page 13). Always fill your spa through both filter wall fittings.**

### 11.3 Cleaning The Spa Interior

To preserve the sheen of your spa's surface, it is crucial that you avoid using abrasive cleaners or cleaners which have adverse chemical effect on the surface. If you are not certain as to the suitability of a particular cleanser, consult your authorized Jacuzzi dealer. Regardless of the cleanser used, use extreme care to assure that no soap residue is

left on the surface. This could cause severe sudsing when the spa is refilled.

#### 11.4 Pillow Care

Remove and clean the headrest pillows as needed with soapy water using a cloth or soft-bristle brush. To maintain water resistance and luster, apply a quality vinyl conditioner once a month. Always remove the pillows when adding chemical shock treatment to the spa water. When the sanitizer reading is below 5 ppm, pillows can be reinstalled.



**CAUTION:** Never attempt to remove the pillows by pulling on the complete assembly! The pillows utilize a bolt-on design that prohibits removal without tools.

To remove pillows:

1. Grasp pillow insert (A) with finger tips and gently pry outward from pillow base (C).
2. Use a standard screwdriver to loosen and remove mounting bolts (B) from pillow base.
3. Assemble in reverse order after cleaning. **DO NOT overtighten pillow mounting bolts!**

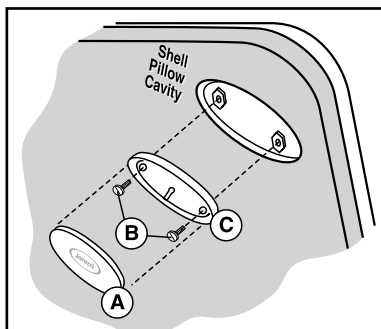

#### 11.5 Maintaining The Cover

Using the Jacuzzi insulating spa cover anytime the spa is not in use will significantly reduce your operating costs, heat-up time and maintenance requirements. To prolong the life of the cover, handle it with care and clean it regularly using mild soap and water. Periodic treatments with a special conditioner developed for Jacuzzi spa covers, will help protect against deterioration caused by UV rays from the sun. Never allow anyone to stand or sit on the cover, and avoid dragging it across rough surfaces.

#### 11.6 Maintaining The Synthetic Cabinet

Your new Jacuzzi synthetic spa cabinet requires little or no maintenance of any kind. To clean, simply wipe cabinet with a clean towel and mild soap solution.



**CAUTION:** Never spray cabinet with a garden hose for any reason since this action may induce an electrical short in the spa's electrical equipment.

### 11.7 Winterizing

Your Jacuzzi® spa is designed to automatically protect itself against freezing when operating properly. During periods of severe freezing temperatures, you should check periodically to be certain that the electrical supply to the spa has not been interrupted. In extreme, bitter cold weather less than -20°F (-29°C), choose the F3 “Standard” skimming/heating mode to prevent freezing (page 25).

If you do not intend to use your spa, or if there is a prolonged power outage during periods of severe freezing temperatures, it is important that all water be removed from the spa and equipment to protect against damage from freezing. **For expert winterization of your spa, contact your authorized Jacuzzi dealer.** In emergency situations, damage can be minimized by taking the following steps:

1. Turn off power to the spa.
2. Follow the directions on page 29-30 for draining the spa.
3. As the water level drops below the seats, use whatever means necessary to get the water out of the recessed seating areas and into the footwell.
4. When the water level ceases to drop, use whatever means available to remove any remaining water from the footwell.
5. Remove the equipment-side cabinet panel and locate the drain plugs in the front of the pump(s) (Figure-A, page 12). Remove these plugs to allow the water to drain out of the pumps and heater. *Note: Approximately one to two gallons will be released during this procedure. Use a wet/dry vacuum or other means to keep this from flooding the equipment compartment. Replace the drain plugs.*
6. Loosen the hose clamp on the circulation pump intake behind the control box (Figure-A, page 12) and pull the hose off (twist hose back and forth while pulling outward). Tip hose down and allow to drain, then reinstall hose and clamp.
7. Re-install cabinet side panel and cover spa so that no casual moisture can enter into it.

Consult your authorized Jacuzzi dealer if you have any questions regarding winter use or winterizing.



### 11.8 Restarting Your Spa in Cold Weather

If you want to start up your spa after it has sat empty for a time in freezing temperatures, be aware that the water remaining in certain sections of the piping may still be frozen. This situation will block water flow preventing the spa from operating properly and possibly damaging the equipment. We recommend you consult your authorized Jacuzzi dealer for guidance before attempting to re-start your spa under these conditions.

### 12.0 Water Quality Maintenance

Maintaining the quality of the water within specified limits will serve to enhance your enjoyment and prolong the life of the spa's equipment. It is a fairly simple task, but it requires regular attention because the water chemistry involved is a balance of several factors. There is no simple formula, and there is no avoiding it. A careless attitude in regard to water maintenance will result in poor and potentially unhealthful conditions for soaking and even damage to your spa. For specific guidance on maintaining water quality, consult your authorized Jacuzzi dealer who can recommend appropriate chemical products for sanitizing and maintaining your spa.



**CAUTION:** *Never store spa chemicals inside the spa's equipment bay.*

### 12.1 pH Control

pH is a measure of relative acidity or alkalinity of water and is measured on a scale of 0 to 14. The midpoint of 7 is said to be neutral, above which is alkaline and below which is acidic. In spa water, IT IS VERY IMPORTANT TO MAINTAIN A SLIGHTLY ALKALINE CONDITION OF 7.2 to 7.8. Problems become proportionately severe the further outside of this range the water gets. A low pH will be corrosive to metals in the spa equipment.

A high pH will cause minerals to deposit on the interior surface (scaling). In addition, the ability of the sanitation agents to keep the spa clean is severely affected as the pH moves beyond the ideal range. That is why almost all spa water test kits contain a measure for pH as well as sanitizer.



## 12.2 Sanitizing

To destroy bacteria and organic compounds in the spa water, a sanitizer must be used regularly. Chlorine and bromine are the two most popular sanitizers used to date. Many other additives are available for your spa. Some are necessary to compensate for out-of-balance water, some aid in cosmetic water treatment and others simply alter the feel or smell of the water. Your authorized Jacuzzi dealer can advise you on the use of these additives.



**CAUTION:** *Do not use chlorine tablets (trichlor) in your spa. This chemical can have an extremely corrosive effect on certain materials in the spa. Damage caused by use of this chemical, or improper use of any chemicals, is not covered under the spa's warranty.*

## 12.3 Optional CD Ozone Water Maintenance System

If you have elected to have your spa equipped with the optional Jacuzzi CD ozone water purification system you will find that your water stays fresh and clear with significantly less chemical sanitizer usage. You will also probably be able to go longer between complete spa drainings. The CD ozone unit operates in conjunction with the circulation pump.

## 13.0 Error Conditions / Error Messages

### 13.1 Summer Logic

When the actual spa water temperature reaches up to 2°F (1°C) above the set temperature, the spa goes into “summer logic” causing the circulation pump and heater to turn off automatically. This will avoid the addition of heated water to the spa, which would eventually create an overheat condition. This setting is not user-programmable.

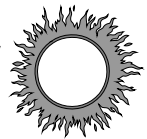

**Note:** *The summer logic does not take effect until the spa water temperature reaches 95°F (35°C). This condition is more likely in excessively hot weather. Remember, the spa's ability to cool is directly affected by the ambient temperature. An excessively hot ambient temperature may prevent the spa from cooling down because it's fully insulated construction is designed to retain heat and to minimize operating costs.*



### 13.2 Overheat Condition

**WARNING! DO NOT ENTER SPA WATER!** Water is too hot. Overheat protection. Heater is deactivated. Spa water temperature is above acceptable limits. Do not enter the water

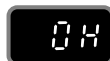

#### To correct condition:

1. Remove the spa's cover and allow your spa to cool down.
2. Program the filter settings for Economy Mode (F4-F6) (page 25). Raise water temperature setting to cancel Summer Logic condition (page 34).
3. If the condition persists, contact your authorized Jacuzzi dealer.

### 13.3 Panel Displays SN1

Open sensor (heater is disabled) or shorted sensor (spa is deactivated). The high-limit temperature sensor is not functioning. Your authorized Jacuzzi dealer/service center must repair this.

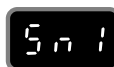

### 13.4 Panel Displays SN2

Open or shorted sensor (heater disabled). The temperature sensor is not functioning. Your authorized Jacuzzi dealer must repair this

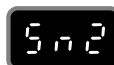

### 13.5 Panel Displays FL1 or FL2

A flashing "FL1" display means the flow switch is malfunctioning open, the circulation pump's filter cartridge is excessively dirty, or an "air lock" condition has occurred at the circulation pump intake. A flashing "FL2" display means the flow switch is malfunctioning closed.



- This error will cause the heater to deactivate. The main pump #1 may also deactivate.
- This problem is caused by an interruption in water flow from an excessively dirty filter cartridge, an "air lock" condition at the pump intake, or by a malfunctioning flow switch.



### To Correct Condition:

1. Check for proper water level. Water should be 1" below lowest pillow.
2. Check for clogged/excessively dirty circulation pump filter cartridge (control panel side). See section 11.1, (page 27-28).
3. Purge "air lock" from circulation pump intake by removing its filter cartridge (control panel side). Place your garden hose over the heater return wall fitting near the underwater spa light (sec. 8.2, page 19). Turn-on water for 30 seconds, then turn off. Reinstall filter cartridge and check spa. See section 11.1, (page 27-28).
3. If problem persists, contact your authorized Jacuzzi dealer.

### 13.6 Panel Displays COL

Cool Condition - Temperature has dropped 20°F (11°C) below the current set temperature. The pump and heater have been activated to bring the temperature to within 15°F (8°C) of the set temperature. No corrective action is required. *Note: during cold periods, you may consider increasing the number of filtration cycles.*

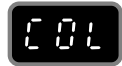

### 13.7 Panel Displays ICE

Freeze Protection - A potential freeze condition has been detected. No action is required. Main pump #1 will operate to circulate warm water through the plumbing until the spa is out of danger.



### 13.8 Panel Displays - - -

The safety "Watchdog" software has been triggered and the spa is deactivated. A problem has been detected which could cause damage to the spa or its components. Contact your authorized Jacuzzi dealer.



## 14.0 Troubleshooting Procedures

In the event your Jacuzzi® spa is not working the way it should, please first review all the installation and operating instructions in this manual and check the message on the panel display. If you are still not satisfied it is working properly, please follow the appropriate troubleshooting instructions. *Note: If any of the supply cords to the accessories are damaged, they must be replaced by an authorized Jacuzzi dealer or service personnel.*





### 14.1 None of the Components Operate (e.g. Pump, Light)

Check the following:

1. Is there power to the spa?
2. Is the household circuit breaker tripped?
3. Call your authorized Jacuzzi dealer.

### 14.2 Pump Does Not Operate but Light Does

Press the Jets 1 Button:

1. If no water movement is detected, make sure power is going to the spa and check the water level. If it does not solve the problem, contact your authorized Jacuzzi dealer.
2. The main pump #1 operates but no water flows to jets. one of the Jets pumps may not be properly primed. This can happen after the spa is drained and refilled. Press the Jets 1 button several times, never leaving the pump on for more than 5 to 10 seconds at a time. Turn power off and let the air out by loosening the cap on the diverter valve and/or remove the filter, (page 19). Make certain you tighten the diverter cap and/or reinstall the filter before turning on spa power and restarting the pump.

### 14.3 Poor Jet Action

1. Press the Jets 1 button to make certain that jets pump #1 is on.
2. Depress the air control to the "on" position.
3. Check for dirty filter. Clean, if necessary.
4. Make sure all adjustable jets are open.

J-335, J-345 models include filters on their footwell suction covers that prevent debris from entering jets pump #2, when operating. These filters must remain in place to protect jets pump #2 plumbing network. They should be cleaned every 2 months, or when weak pump #2 performance is observed.





#### **14.4 Water is Too Hot**

1. Reduce thermostat setting.
2. Reduce skimming/heating cycle length. Even with heater off, water temperature can increase from prolonged pump operation (section 10.4, page 25-26).
3. Manually induce “Summer Logic” by setting water temperature to a value of 2 degrees less than the current set temperature. Refer to section 9.1 (page 22) for further details.

#### **14.5 No Heat**

1. Check thermostat setting.
2. Keep the spa cover in place while heating.
3. Check the settings to see if your spa is in economy mode (page 25-26). Should checking the above steps fail to correct the problem, please call your dealer so that they may arrange service.

We build the best spas in the industry. Nonetheless, we are always striving to improve the quality and features of our products. Your input as a Jacuzzi spa owner is a cherished part of this process. If you have any comments or suggestions, or if you wish to be informed on any new products for your spa, please write to us.

**CONGRATULATIONS** on your good taste and welcome to the happiest and most relaxed family in the world!

## 15.0 J-315, Convertible Circuit Diagram (60Hz)

This wiring diagram is used for the J-315, US/Canada 120/240 VAC (60Hz) convertible power model.

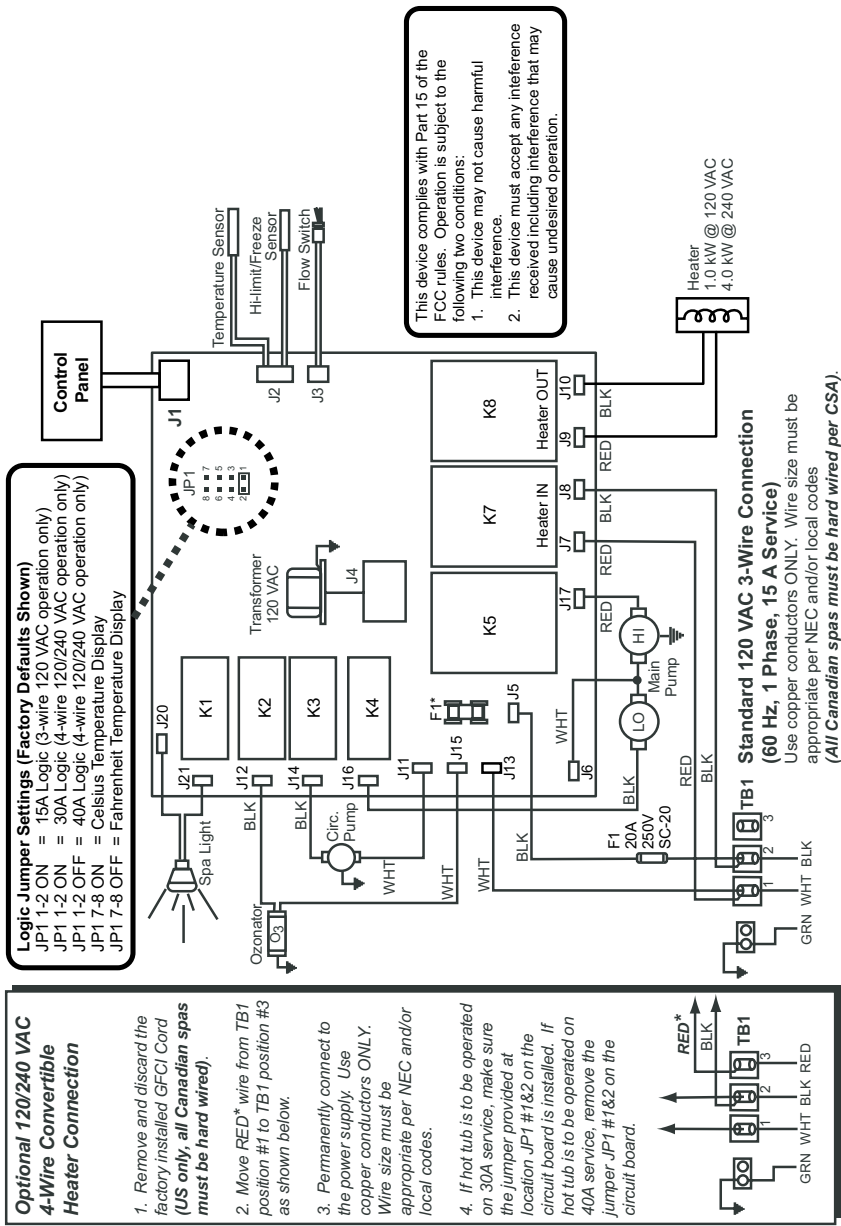



## 16.0 J-325, J-335, J-345 Circuit Diagram (60Hz)

This wiring diagram is used for all J-325, J-335, J-345 US/Canada 240 VAC (60Hz) dedicated power models.

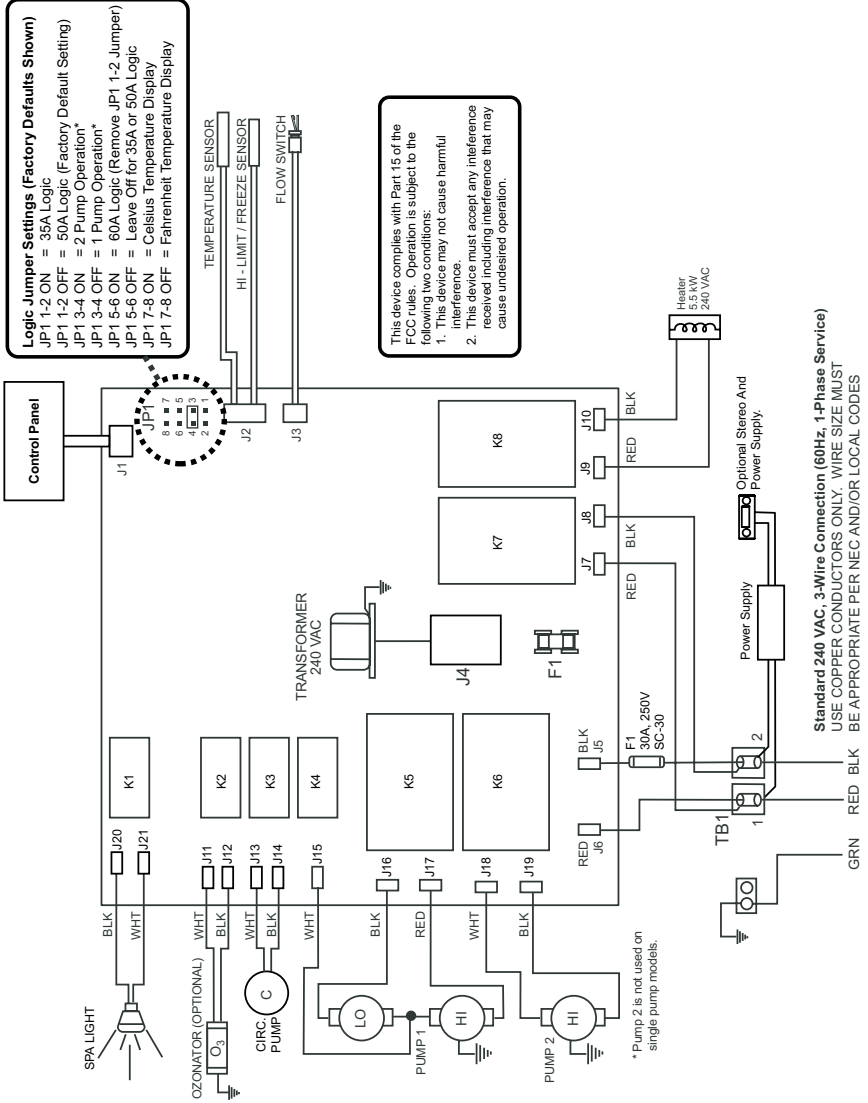

## 17.0 J-315 Export Circuit Diagram (50Hz)

This wiring diagram is used for the J-315 Export 230 VAC (50Hz) dedicated power model.

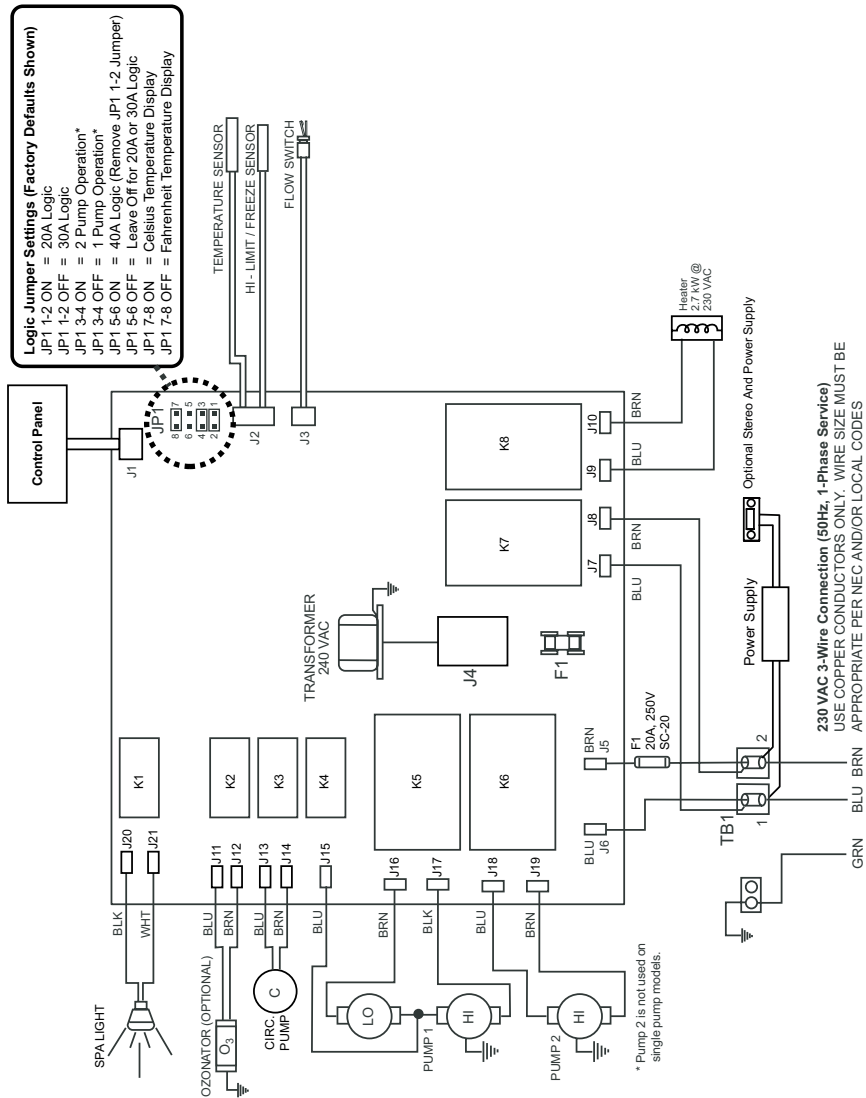



## 18.0 J-325 ,J-335, J-345 Circuit Diagram (50Hz)

This wiring diagram is used for all J-325, J-335, J-345 Export 230 VAC (50Hz) dedicated power models.

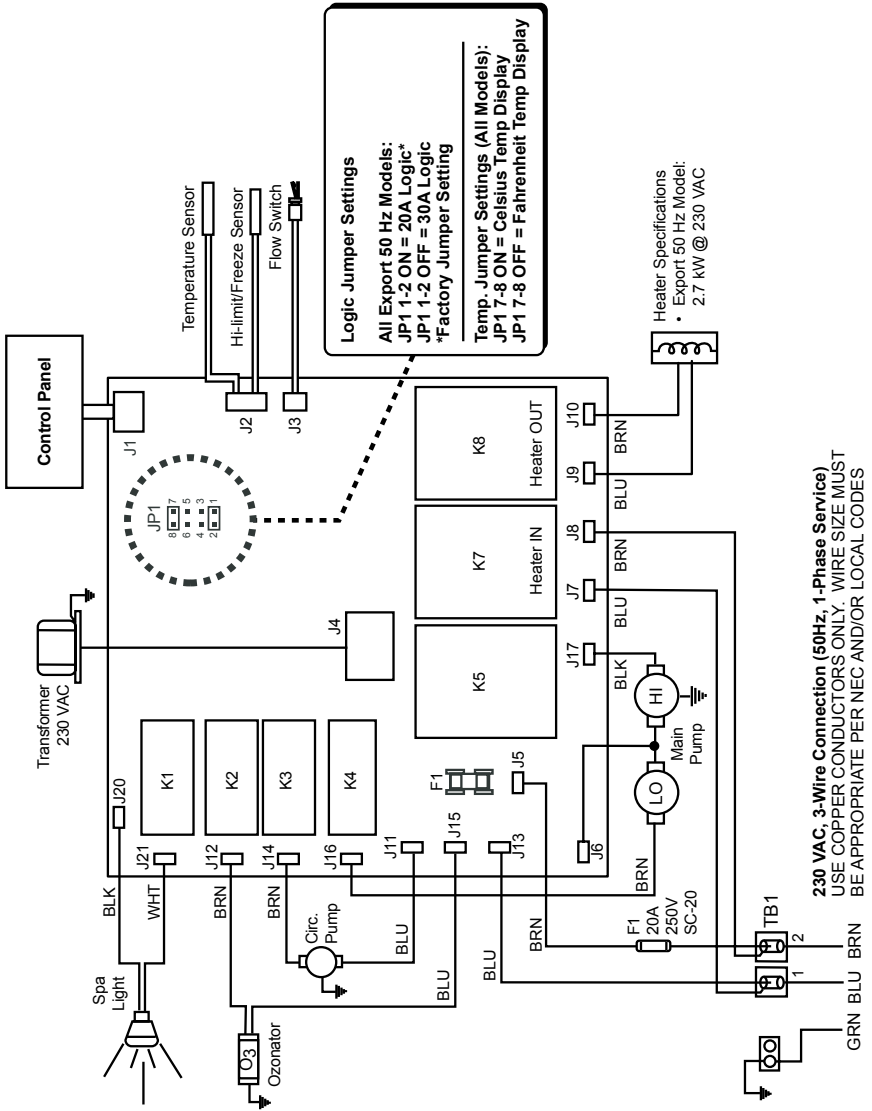

## 19.0 Optional Stereo Receiver Functions

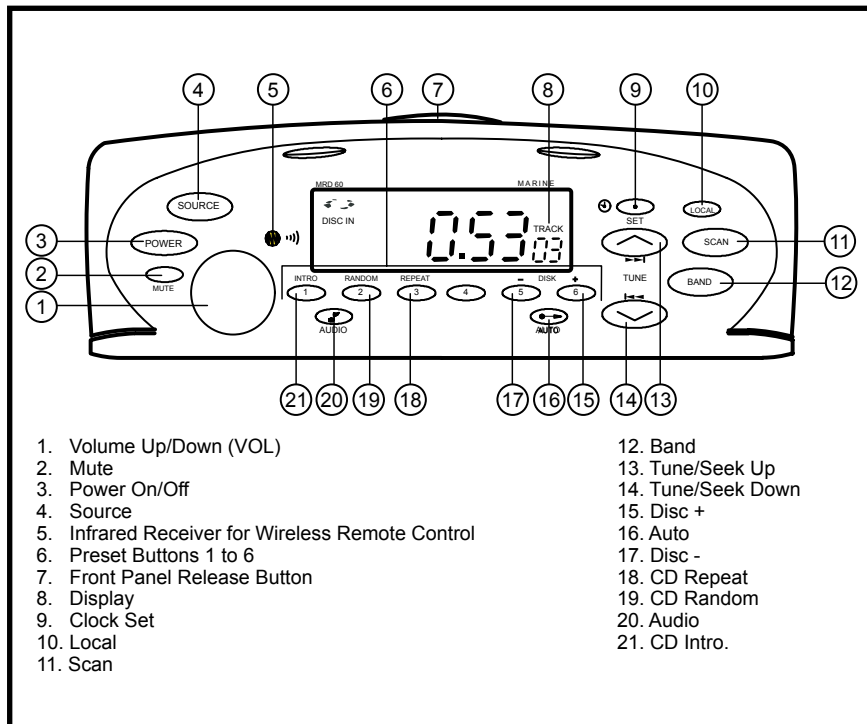

- |                                                  |                    |
|--------------------------------------------------|--------------------|
| 1. Volume Up/Down (VOL)                          | 12. Band           |
| 2. Mute                                          | 13. Tune/Seek Up   |
| 3. Power On/Off                                  | 14. Tune/Seek Down |
| 4. Source                                        | 15. Disc +         |
| 5. Infrared Receiver for Wireless Remote Control | 16. Auto           |
| 6. Preset Buttons 1 to 6                         | 17. Disc -         |
| 7. Front Panel Release Button                    | 18. CD Repeat      |
| 8. Display                                       | 19. CD Random      |
| 9. Clock Set                                     | 20. Audio          |
| 10. Local                                        | 21. CD Intro.      |
| 11. Scan                                         |                    |

### A. Power On and Off

Make sure spa power is turned on, then press the power button (3) once to turn on. Press a second time to turn off.

### B. Adjusting Volume

Rotate the volume knob (1) to increase or decrease volume. Current volume setting is briefly indicated on the display (0 to 31).

### C. Mute

Press the mute button (2) once to mute the audio output ("Mute" flashes on the display). To restore audio output, press the mute button a second time, or rotate the volume knob.

### D. Program Selection

Press the source button (4) to cycle through available program sources as follows: Tuner - CD - Tuner. If a source is unavailable (e.g. no CD inserted), that source will not appear on the display.



### **E. Adjusting Bass Level**

Press the audio button (20) until the display reads “BAS.” Rotate the volume knob to the desired setting. A display of “C O” indicates center, -2 to -12 indicates bass cut, and +2 to +12 indicates bass boost. *Note: the unit returns to volume mode if the volume control is not rotated for 3 seconds.*

### **F. Adjusting Treble Level**

Press the audio button (20) until the display reads “TRE.” Rotate the volume knob to the desired setting. A display of “C O” indicates center, -2 to -12 indicates bass cut, and +2 to +12 indicates bass boost. *Note: the unit returns to volume mode if the volume control is not rotated for 3 seconds.*

### **G. Adjusting Balance**

Press the audio button (20) until the display reads “BAL.” Rotate the volume knob to the desired setting. A display of “C O” indicates center, L1 to 15 indicates left balance, and R1 to 15 indicates right balance. *Note: the unit returns to volume mode if the volume control is not rotated for 3 seconds.*

## **Optional Stereo Receiver Radio Operation**

### **A. Adjust Fader**

Press the audio button (20) until the display reads “FAD.” Rotate the volume knob to the desired setting. A Display of “C O” indicates center, R1 to 15 indicates rear fade, and F1 to 15 indicates front fade. *Note: the unit returns to volume mode if the volume control is not rotated for 3 seconds.*

### **B. Display Clock**

Press the set button (9) to toggle the display between the clock and radio modes. When the clock mode is selected, the current time displays whenever the unit is left undisturbed.

### **C. Set Clock**

Press the set button (9) for 2 seconds until the first time digit flashes on the display. Use the tune/seek up button (13) or the tune/seek down button (14) to set the hour, noting the AM/PM indicator at the left. Briefly press the set button a second time to select the minutes display. Press the set button a third time to complete the procedure. The unit remains in clock mode and displays the time after 3 seconds. *Note: When power to the spa is shut off for any reason, the clock will be reset to 12:00AM.*





#### D. Open/Close Front Panel

Place your thumb on the front panel release button (7) with your forefinger below the front overhang. Press firmly on the release button, then flip the panel open by pulling outward at the top edge. To close the panel, flip the panel up and press firmly until you hear an audible click. Keep the front panel closed at all times to prevent water intrusion, except when changing discs.



**CAUTION: never insert wet discs into the unit or the CD player will be damaged!**

#### E. Radio Operation

Press the source button (4) to select the radio mode. The station frequency is indicated on the display.

- To Select Band: press the band button (12) to toggle through the radio modes as follows: FM1 - FM2 - FM3 - AM1 - AM2 - FM1. Each radio band stores up to 6 independent presets, for a total of 18 FM and 12 AM presets.
- To Program Presets: tune in to the desired radio station, then press and hold the desired preset button for at least 2 seconds. "PX", where X = the preset number, appears at the bottom right of the display.

**Note:** When power to the spa is shut off for any reason, all station presets are reset.

#### F. Automatically Setting Station Presets

To automatically set station presets to their next higher stations, press the preset button (1 to 6) from which to start programming, then press and hold the auto button (16) for at least 2 seconds. The current preset and the additional preset memories up to P6 will be reprogrammed with their next higher stations. When the auto preset cycle is complete, the unit will remain in preset scan mode and continue scanning for presets until the auto button (16) is pressed. To select only the strongest stations, press the local button (10). All 18 FM and 12 AM presets can be set sequentially by selecting the next band and continuing the operation during auto programming.

#### G. Seek / Manual Tune

Press the tune/seek up button (13) once to automatically tune to the next higher station. Press the tune/seek down button (14) once to automatically tune to the next lower station. To manually tune to a specific station



frequency, press and hold either tune/seek button for at least 2 seconds. Holding either button down will increase or decrease the displayed frequency manually. When the desired frequency is reached, release the button. The unit remains in manual tune mode for 3 seconds after either button is released so you can fine tune the station frequency with additional button presses. **Note:** *After 3 seconds, the seek mode is re-enabled.*

## H. Scan Functions

Select any AM or FM band and press the scan button (11) to listen to a few seconds of each radio station. The display will flash and the radio will automatically scan to the next higher station. To stop scanning and continue listening to the current station, press the scan button a second time. **Note:** *the radio remains in scan mode until the scan button is pressed a second time or one of the tune buttons is pressed.*

## I. Preset Scan Function

Press the auto button (16) once to enter scan mode. The next higher preset station will be selected and be played for 3 seconds while the preset number on the display flashes. If you wish to remain on this station, press the auto button (16) a second time.

**Note:** *preset scanning continues unless you press the auto button (16) or either preset button (P1-P6) to cancel.*

## J. Local/Distance Function

Press the local button (10) to toggle between local and distant station mode. When "LOCAL" is displayed, only the strongest stations will be selected during seek or scan. **Note:** *in the default mode (no LOCAL display), all usable stations will be selected during seek or scan.*

## K. Changing Tuner Frequency From US To Europe

Your unit is factory set to US tuning frequency steps. To switch to Europe tuning steps, use the switch on the bottom of the unit. With the unit disconnected from the power source, use a screwdriver to *slide the switch to the desired position.*

**Note:** *power must be removed from the radio, or the reset switch must be pressed before the new frequency mode is activated.*



## Optional Stereo Receiver CD Player Operation

### A. Insert, Play, And Eject A CD

Open the front panel and insert a CD into the slot with the CD label facing up. The CD will be drawn inside by the motorized mechanism. Close the front panel. The “DISC IN” symbol on the display indicates that a CD is in the drive.

- To play the CD: press the source button (4) to change to CD mode. The CD will play. The display shows the current track and play time, and will animate a 3-D rotating disc while the CD is playing. *Note: if the CD play time is not shown, press the clock button (9) once.*
- To remove the CD: open the front panel and press the CD eject button located under the front panel. Remove the CD from the drive and close the front panel.

***Note: listen for an audible click to ensure the front panel is closed to prevent water intrusion that could damage your unit.***

### B. Changing CD Tracks And Music Seek

To advance to next track, press the tune/seek up button (13) once and the track counter will increase one track. When the final track is reached on the CD, play will resume on track #1.

- To fast forward through tracks: press and hold the tune/seek up button (13) until the track counter displays the desired track, then release the button.
- To return to the beginning of the current track: press the tune/seek down button (14). Pressing it a second time within 1 second will skip back to the previous track.
- To rewind the current track: press and hold the tune/seek down button (14). The track will quickly rewind until you release the button.

### C. Intro Scan, Random, Repeat

- Intro Scan Mode: press intro button (21) to enter intro scan mode. The left side of the display reads “SCN” and the first 10 seconds of each CD track will play continuously until you press the intro button a second time, or press either tune/seek buttons (13 or 14).
- Random Mode: press the random button (19) to play the CD track in a random order. The left side of the display reads “RDM” when random mode is enabled.



- Repeat Mode: press the repeat button (18) to repeat the current CD track continuously. The left side of the display reads “RPT” when the repeat mode is enabled.

## Optional Stereo Receiver Troubleshooting

### A. Unit will not turn on.

- Make sure the spa power is turned on, then check both harness fuses on the back of the unit, making sure they are the proper ratings:
- Yellow memory B+ line (1A fuse); Red ACC line (10A fuse).
- With the spa power off, use a thin rod to press the reset button located under the front panel.

### B. Fogged CD's And Lens

This condition may occur when it's cold. Wipe fogged CD's with a soft cloth. Fogged optical components inside the unit will return to normal operation after an hour in a heated environment.

## Optional Wireless Remote Control

(Standard on models with stereo options. Can be purchased separately.) To ensure maximum life of the optional wireless stereo remote, we recommend never submerging it in water or leaving it under the spa cover! Prolonged exposure to moisture will damage the remote.

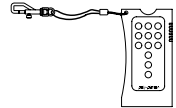

## Optional Wireless Remote Battery Replacement Procedure

Remove the remote from the rubber housing, then remove the protective adhesive seal from the battery door. Depress the hook with a thumbnail and pull outward on the battery door. Replace the depleted battery with a fresh battery, making sure to note the polarity. Re-install the battery door. Replace the adhesive seal material, making sure to cover the entire gap (additional seal material is included, if required). Replace the remote firmly into the rubber housing.

## Wireless Remote Control Specifications

Usable range ..... 15 ft. (5m)  
 Battery ..... Coin Type, CR2025 or equivalent



## Optional Stereo Receiver Specifications

### Tuner

FM usable sensibility .....	10dBf
FM 50 dB quieting sensitivity .....	15dBf
FM alternate channel selectivity .....	90dBf
FM stereo separation @ 1kHz .....	60dBf
AM usable sensitivity .....	30uV

### CD Player

Sampling frequency (8X oversampling) .....	44.1kHz
Channel separation @1 kHz .....	80 db
Signal-to-noise ratio .....	90 dBA
Frequency-to-noise response @ $\pm 1$ dB .....	20-20 kHz

### Audio

Maximum power output (45 watts x 4 channel) .....	180W
Continuous power, 20-20 kHz, 4 ohms 1% THD .....	18 x 4
Bass boost/cut .....	10/100 $\pm$ dB/Hz
Treble boost/cut .....	10/10+/-dB/kHz

### General

Nominal power supply .....	14.4VDC
Allowable power supply .....	10.8 - 15.6 VDC
Current consumption .....	<10Amps
Speaker impedance .....	4-8 Ohms



**The following UL requirements must be observed for all spas with optional stereo components installed.**

- A. "CAUTION - Risk of Electric Shock. Do not leave compartment door open";
- B. "CAUTION - Risk of Electric Shock. Replace components only with identical components"; and
- C. Do not operate the audio/video controls while inside the spa."
- D. "WARNING - Prevent Electrocution. Do not connect any auxiliary components (for example: cable, additional speakers, headphones, additional audio/video components etc.) to the system."
- E. These units are not provided with an outdoor antennae; when provided, it should be installed in accordance with Article 810 of the National Electric Code, ANSI/NFPA 70.
- F. Do not service this product yourself as opening or removing covers may expose you to dangerous voltage or other risk of injury. Refer all servicing to qualified service personnel.
- G. When the power supply connections or power supply cord(s) are damage; if water is entering the audio/video compartment or any electrical equipment compartment area; if the protective shields or barriers are showing signs of deterioration; or if there are signs of other potential damage to the unit, turn off the unit and refer to a qualified service personnel.
- H. This unit should be subjected to periodic routing maintenance (for example, once every 3 months) to make sure that the unit is operating properly.





Jacuzzi® Hot Tubs  
14525 Monte Vista Ave.  
Chino, Ca 91710  
United States  
[www.jacuzzi.com](http://www.jacuzzi.com)

6530-377, Rev. A

Printed in The USA