



680 SERIES

BURLINGTON™ | DENALI™ | HARTFORD™ | HAWTHORNE™ | TACOMA™

OWNER'S MANUAL

6530-681U Rev. B

Sundance® Spas

Attention New Spa Owner!

Congratulations on the purchase of your new Sundance® 680 Series spa! The following is a list of automated functions and maintenance recommendations for your new spa. Automated functions have been listed below in an attempt to suppress any operational concerns you may have during startup and the first 24 hours of ownership! Maintenance recommendations are listed in an attempt to stress their importance in protecting your new spa.

Automated Operations

Approximately two minutes after power is applied to the spa, the first filtration/heating cycle turns on pump 1. In Hartford and Hawthorne models, an automatic five minute “blow-out” function also activates pump 2 for a period of five minutes to flush all lines. Then, after five minutes, pump 2 turns off and pump 1 continues to operate for the duration of the cycle.

Note: This function only occurs during the first filtration/heating cycle each day.

Maintain Healthy Spa Water

Always maintain your spa’s water chemistry within the following parameters as defined by the Association of Pool And Spa Professionals/USA:

pH	7.4-7.6
Free Chlorine	3.0-4.0 ppm
Free Bromine	2.0-4.0 ppm
Total Alkalinity	100-120 ppm
Calcium Hardness	150-250 ppm

Always maintain your spa filter as outlined below to ensure healthy spa water. Refer to pages 34-35 for additional information.

Required Filter Maintenance

Your new spa is equipped with an advanced water filtration system that provides unsurpassed water quality! To ensure maximum water quality at all times, you should clean and reuse both filter cartridges every month or as needed. See page 30 for detailed filter cleaning/replacement instructions.

Required Water Maintenance

You should replace the spa’s water every 3 months. The frequency depends on a number of variables including frequency of use, number of users, and attention paid to water quality maintenance. You will know it is time for a change when you cannot control sudsing and/or you can no longer get the normal feel or sparkle to the water, even though the key water balance measurements are all within the proper parameters. See pages 34-35 for additional information.

Table of Contents

1.0	Important Spa Owner Information	1
2.0	FCC Notice	1
3.0	Important Safety Instructions	2
3.1	Important CSA Safety Instructions (Canada only).....	4
3.2	Hyperthermia.....	5
3.3	Cautions.....	6
3.4	General Electrical Safety Instructions.....	6
4.0	Choosing A Location	8
4.1	Outdoor Location.....	8
4.2	Indoor Location.....	9
5.0	Power Requirements	10
5.1	North American 60 Hz Power Options.....	10
5.2	Export 50 Hz Power Options.....	12
6.0	Electrical Wiring Instructions	13
7.0	Spa Fill Up Procedure	16
8.0	Control Functions	21
8.1	Control Panel.....	21
8.2	General Spa Features And Controls.....	22
9.0	Operating Instructions	23
9.1	Setting Water Temperature.....	23
9.2	Activate Pumps.....	23
9.3	SunGlow™ Light Operation (Denali and Tacoma Models).....	24
9.4	Standard Light Operation (Burlington, Hartford and Hawthorne Models).....	24
9.5	Optional Multi-Colored LED Light System Operation (Burlington, Hartford and Hawthorne Models).....	24
9.6	Adjusting Individual Jet Flow.....	25
9.7	Selecting Desired Massage Action.....	26
9.8	Air Controls.....	26
9.9	Optional Audio System.....	26

10.0	Automatic Filtration Cycles	27
10.1	Standard Filtration/Heating Modes For Models <u>Without</u> Circulation Pump Option	27
10.2	Standard Filtration/Heating Modes For Models <u>With</u> Circulation Pump Option	27
10.3	Economy Filtration/Heating Modes (F4-F6).....	27
10.4	Lock Modes (L1-L2).....	27
10.5	Selecting The Filtration/Heating Mode	28
10.6	Filtration Modes for Spas <u>Without</u> Circulation Pump Option	28
10.7	Filtration Modes for Spas <u>With</u> Circulation Pump Option	29
11.0	Spa Maintenance.....	30
11.1	Cleaning The Filter	30
11.2	Draining and Refilling	31
11.3	Pillow Care (All Models Except Denali)	32
11.4	Cleaning The Spa Interior.....	33
11.5	Maintaining The Cover	33
11.6	Maintaining The Synthetic Cabinet.....	33
11.7	Winterizing.....	33
11.8	Restarting Your Spa in Cold Weather	34
12.0	Water Quality Maintenance	34
12.1	pH Control	35
12.2	Sanitizing	35
12.3	CD Ozone Water Maintenance System.....	35
13.0	Error Conditions/Error Messages	36
13.1	Summer Logic (Spas <u>With</u> Circulation Pump Option).....	36
13.2	Panel displays SN1	36
13.3	Panel displays SN2	36
13.4	Panel Flashes FL1 or FL2 (Spas <u>Without</u> Circulation Pump Option)	36
13.5	Panel Flashes FL1 or FL2 (Spas <u>With</u> Circulation Pump Option)	37
13.6	Panel displays COL	37
13.7	Panel Displays ICE.....	37
13.8	Panel Displays OH	37
13.9	Panel displays - - -	38
14.0	Troubleshooting Procedures	38
14.1	None of the Components Operate (e.g. Pump, Light).....	38
14.2	Pump Does Not Operate but Light Does	38
14.3	Poor Jet Action	39

14.4	Water is Too Hot	39
14.5	No Heat	39
15.0	North American Denali/Tacoma Convertible Circuit Diagram (60 Hz)	40
16.0	North American Burlington Models (60 Hz).....	41
17.0	North American Hartford and Hawthorne Models (60 Hz)....	42
18.0	Export Denali/Tacoma Circuit Diagram (50 Hz).....	43
19.0	Export Burlington Circuit Diagram (50 Hz).....	44
20.0	Export Hartford and Hawthorne Circuit Diagram (50 Hz).....	45
21.0	Optional SunSound™ Stereo Receiver Functions (Burlington, Hartford and Hawthorne Models Only).....	46
21.1	Optional SunSound™ Audio Receiver Specifications	51

1.0 Important Spa Owner Information

Your Sundance® 680 Series spa is constructed to the highest standards and is capable of providing many years of trouble-free use. However, because heat retentive materials are utilized to insulate the spa for efficient operation, an uncovered spa surface and wall fittings directly exposed to sunlight and high temperatures for an extended period are subject to permanent damage or discoloration. Damage caused by exposing the spa to this abuse is not covered under warranty. We recommend that you always keep the spa full of water when it is exposed to direct sunlight and that you keep the Sundance premium insulating cover in place at all times when the spa is not in use. Read and carefully follow the requirements for your spa's support base found in Section 4.0 titled, "Choosing a Location" (page 8).

Sundance constantly strives to offer the finest spas available, therefore modifications and enhancements may be made which affect the specifications, illustrations and/or instructions contained herein.

2.0 FCC Notice

This equipment has been tested and found to comply with the limits for a Class B Digital Device, pursuant to Part 15 of the FCC Rules. These limits are designed to provide reasonable protection against harmful interference in a residential installation. This equipment generates, uses and can radiate radio frequency energy and, if not installed and used in accordance with the instructions, may cause harmful interference to radio communications. However, there is no guarantee that interference will not occur in a particular installation. If this equipment does cause harmful interference to radio or television reception, which can be determined by turning the equipment off and on, the user is encouraged to try to correct the interference by one or more of the following measures:

1. Rearrange or relocate the receiving antenna.
2. Increase the separation between the equipment and receiver
3. Connect the equipment into an outlet on a circuit different from the circuit connected.
4. Consult the dealer or an experienced radio/TV technician for help. Changes or modifications not expressly approved by the party responsible for FCC compliance could void the user's authority to operate this equipment.

3.0 Important Safety Instructions

READ AND FOLLOW ALL INSTRUCTIONS CAREFULLY!

When installing and using this electrical equipment, basic safety precautions should always be followed, including:

1. **WARNING:** To reduce the risk of injury, do not permit children to use this product unless they are closely supervised at all times.
2. **WARNING:** A grounding wire connector is provided on this unit to connect a minimum No. 8 AWG (8.4 mm²) solid copper conductor between this unit and any metal equipment, metal enclosures of electrical equipment, metal water pipe, or conduit within 5 feet (1.5m) of the unit.
3. **DANGER: Risk of Accidental Drowning.** Extreme caution must be exercised to prevent unauthorized access by children. To avoid accidents, ensure that children cannot use this spa unless they are supervised at all times.
4. **DANGER: Risk of Severe Injury or Drowning!**
The suction fittings in this spa are sized to match the specific water flow created by the pump. If it is necessary to replace the suction fittings or the pump, be sure that the flow rates are compatible.
 - Never operate or use the spa if the filter, filter lid, or skimmer assembly are broken or any part of the skimmer assembly is missing. Please contact your dealer or nearest service center for service.
 - Never replace a suction fitting with one rated less than the flow rate marked on the original suction fitting. Using improper suction fittings can create a body or hair suction entrapment hazard that may lead to drowning or near drowning.
 - Never use the spa unless all suction guards, filter, filter lid, or skimmer assembly are installed to prevent body and/or hair entrapment.
 - Keep hair, loose articles of clothing or hanging jewelry away from suction fittings, rotating jets or other moving components to avoid entrapment that could lead to drowning or near drowning.
5. **DANGER: Risk of Electric Shock.** Install at least 5 feet (1.5m) from all metal surfaces. As an alternative, a spa may be installed within 5 feet (1.5m) of metal surfaces if each metal surface is permanently connected (bonded) by a minimum No. 8 AWG (8.4 mm²) solid copper conductor attached to the wire connector on the grounding lug, inside the equipment compartment on the equipment box.
6. **DANGER: Risk of Electric Shock.** Do not permit any electrical appliance, such as a light, telephone, radio, television, etc. within 5 feet (1.5m) of a spa, unless such appliances are built-in by the manufacturer.

7. **ELECTRICAL SUPPLY:** The electrical supply for this product must include a suitably rated switch or circuit breaker to open all ungrounded supply conductors to comply with Section 422-20 of the National Electrical Code/USA, ANSI/NFPA 70. The disconnect must be readily accessible and visible to the spa occupant but installed at least 5 feet (1.5m) from the spa water.
8. **WARNING:** To Reduce the Risk of Injury:
9. The water in a spa should never exceed 104°F (40°C). Water temperatures between 100°F (38°C) and 104°F (40°C) are considered safe for a healthy adult. Lower water temperatures are recommended for young children and when spa use exceeds 10 minutes.
10. Since excessive water temperatures have a high potential for causing fetal damage during the early months of pregnancy, pregnant or possibly pregnant women should limit spa water temperatures to 100°F (38°C). If pregnant, please consult your physician before using a spa.
11. Before entering the spa, the user should measure the water temperature with an accurate thermometer since the tolerance of water temperature-regulating devices may vary as much as +/- 5°F (2°C).
12. The use of alcohol, drugs, or medication before or during spa use may lead to unconsciousness with the possibility of drowning.
13. Persons suffering from obesity or a medical history of heart disease, low or high blood pressure, circulatory system problems, diabetes, infectious diseases or immune deficiency syndromes should consult a physician before using a spa. If you experience breathing difficulties in association with using or operating your spa, discontinue use and consult your physician.
14. Persons using medication should consult a physician before using a spa since some medication may induce drowsiness, while other medication may affect heart rate, blood pressure, and circulation.
15. Always shower before and after using your spa. To reduce the possibility of contracting a waterborne illness, always maintain water chemistry within the parameters listed on the inside cover of this manual. If you or other bathers experience such a condition, discontinue use and seek medical attention.

3.1 Important CSA Safety Instructions (Canada only)

When using this electrical equipment, basic safety precautions should always be followed, including the following:

- 1. READ AND FOLLOW ALL INSTRUCTIONS.**
- A green colored terminal or a terminal marked G, Gr, Ground, Grounding or the  symbol* is located inside the supply terminal box or compartment. To reduce the risk of electric shock, this terminal must be connected to the grounding means provided in the electric supply service panel with a continuous copper wire equivalent in size to the circuit conductors that supply this equipment (*IEC Publication 417, Symbol 5019).
- At least two lugs marked “Bonding Lugs” are provided on the external surface or on the inside of the supply terminal box/ compartment. To reduce the risk of electric shock, connect the local common bonding grid in the area of the spa to these terminals with an insulated or bare copper conductor not smaller than No. 6 AWG (10 mm²).
- All field-installed metal components such as rails, ladders, drains or other similar hardware within 10 feet (3m) of the spa shall be bonded to the equipment grounding buss with copper conductors not smaller than No. 6 AWG (10 mm²).
- 5. SAVE THESE INSTRUCTIONS.**

WARNING: Children should not use spas without adult supervision.

WARNING: Do not use spas unless all suction guards are installed to prevent body and hair entrapment.

WARNING: People with infectious diseases should not use a spa.

WARNING: To avoid injury, exercise care when entering or exiting the spa.

WARNING: Do not use drugs or alcohol before or during the use of a spa to avoid unconsciousness and possible drowning.

WARNING: Pregnant or possibly pregnant women should consult a physician before using a spa.

WARNING: Water temperature in excess of 40°C (104°F) may be injurious to your health.

WARNING: Before entering the spa, measure the water temperature with an accurate thermometer.

WARNING: Do not use a spa immediately following strenuous exercise.

WARNING: Prolonged immersion in a spa may be injurious to your health.

WARNING: Do not permit electric appliances (such as lights, radios, telephones, televisions, etc.) within 5 feet (1.5m) of this spa unless factory installed.

CAUTION: Maintain water chemistry in accordance with manufacturer's instructions.

WARNING: The use of alcohol or drugs can greatly increase the risk of fatal hyperthermia in spas.

3.2 Hyperthermia

Prolonged immersion in hot water may induce hyperthermia. A description of the causes, symptoms, and effects of hyperthermia are as follows:

Hyperthermia occurs when the internal temperature of the body reaches a level several degrees above the normal body temperature of 98.6°F (37°C). The symptoms of hyperthermia include drowsiness, lethargy, and an increase in the internal temperature of the body. The effects of hyperthermia include:

- Unawareness of impending hazard;
- Failure to perceive heat;
- Failure to recognize the need to exit spa;
- Physical inability to exit spa;
- Fetal damage in pregnant women; and
- Unconsciousness and danger of drowning.

3.3 Cautions

1. Persons suffering from heart disease, diabetes, high or low blood pressure, and any condition requiring medical treatment, pregnant women, the elderly, or infants should consult with a physician before using a spa.
2. The Consumer Products Safety Commission/USA has stated that the water temperature in a spa should not exceed 104°F (40°C). Immersion in water in excess of 104°F (40°C) can be hazardous to your health.
3. Observe a reasonable time limit when using the spa. Long exposures at higher temperatures can cause high body temperature. Symptoms may include dizziness, nausea, fainting, drowsiness, and reduced awareness. These effects could possibly result in drowning.
4. Do not use the spa under the influence of alcohol, narcotics, or other drugs. Use of the spa under these conditions may lead to serious consequences.
5. Always test the spa water temperature before entering the spa. Enter and exit the spa slowly. Wet surfaces can be very slippery.
6. Never bring any electrical appliances into or near the spa. Never operate any electrical appliances from inside the spa or when you are wet unless such appliances are built-in by the manufacturer.
7. Proper chemical maintenance of spa water is necessary to maintain safe water and prevent possible damage to spa components.
8. Use the straps and clip tie downs to secure the cover when not in use. This will help to discourage unsupervised children from entering the spa and keep the spa cover secure in high-wind conditions. There is no representation that the cover, clip tie-downs, or actual locks will prevent access to the spa.
9. This spa is not intended nor designed to be used in a commercial or public application. The spa buyer shall determine whether there are any code restrictions on the use or installation of this spa since local code requirements vary from one locality to another.

3.4 General Electrical Safety Instructions

Your new Sundance® spa is equipped with a “state-of-the-art” equipment system. It contains the most advanced safety and self-protective equipment in the industry. Nonetheless, this spa must be installed properly to ensure dependable usage. Please contact your local Sundance dealer or local building department should you have any questions regarding your installation.

Proper grounding is extremely important. Sundance spas are equipped with a current collector system. A pressure wire connector is provided on the surface of the control box, located outside the equipment door (Figure B, page 15) to permit connection of a bonding wire between this point and any ground metal equipment, metal water pipe or conduit within 5 feet (1.5m) of the spa, or copper clad grounding rod buried within 5 feet (1.5m) of the spa. Bonding wire must be at least No. 8 AWG (8.4 mm²) solid copper wire. This is a most important safety assurance feature.

Before installing your spa, check with your local building department to insure installation conforms to local building codes.

120/240 Volt Denali And Tacoma Convertible Models

A spa connected to a 120 VAC electrical service must be located close enough to a grounded, grounding-type electrical outlet so that the included 10 foot (3m) power cord can be plugged directly into it. **DO NOT USE AN EXTENSION CORD** as this could cause damage to the spa's equipment due to insufficient voltage. The power supplied to this spa must be a dedicated circuit with no other appliances or lights sharing the power provided by the circuit.

Hot Tub Safety Literature

To ensure you have a safe and enjoyable hot tub experience, learn all you can about hot tub safety and emergency procedures. Especially useful are the brochures listed below.

- [Children Aren't Waterproof](#)
- [Pool and Spa Emergency Procedures For Infants and Children](#)
- [Layers of Protection](#)
- [The Sensible Way to Enjoy Your Spa or Hot Tub](#)

The Association of Pool and Spa Professionals publishes these brochures. You can acquire a brochure in one of the ways in the list below.

- Ask your hot tub dealer (they may have copies)
- Go to <http://apsp.org>
- Conduct your own search on the internet
- Write to the following address:

The Association of Pool and Spa Professionals
2111 Eisenhower Avenue
Alexandria VA 22314
703.838.0083

4.0 Choosing A Location

IMPORTANT: Because of the combined weight of the spa, water and users, it is extremely important that the base upon which the spa rests be smooth, flat, level and capable of uniformly supporting this weight, without shifting or settling, for the entire time the spa is in place. If the spa is placed on a surface which does not meet these requirements, damage to the skirt and/or the spa shell may result. Damage caused by improper support is not covered under warranty. It is the responsibility of the spa owner to assure the integrity of the support over time. We recommend a poured, reinforced concrete slab with a minimum thickness of 4 inches (10 cm). Wood decking is also acceptable provided it is constructed so that it meets the requirements outlined above.

The spa must be installed in such a manner as to provide drainage away from it. Placing the spa in a depression without provisions for proper drainage could allow rain, overflow and other casual water to flood the equipment and create a wet condition in which it would sit in. For spas which will be recessed into a floor or deck, install so as to permit access to the equipment, either from above or below, for servicing. Make certain that there are no obstructions which would prevent removal of all side cabinet panels and access to the jets components, especially on the side with the equipment bay.

4.1 Outdoor Location

In selecting the ideal outdoor location for your spa, we suggest that you take into consideration the following:

- The proximity to changing area and shelter (especially in regions subject to cold weather).
- The pathway to and from your spa (this should be free of debris so that dirt and leaves are not easily tracked into the spa).
- The closeness to trees and shrubbery (remember that leaves and birds could create extra work in keeping the spa clean).
- A sheltered environment (less wind and weather exposure can result in lowered operation and maintenance costs).
- The overall enhancement of your environment. It is preferable not to place the spa under an unguttered roof overhang since run-off water will shorten the life expectancy of the spa cover.

4.2 Indoor Location

For indoor installations many factors need to be considered before installing a spa indoors:

- **PROPER FOUNDATION:** Consult a Structural Engineer when considering a foundation that will adequately support the spa the entire time it is in place. Proper support is critical especially if the spa is to rest on a second story or higher. For spas that are to rest on balconies, roofs or other platforms not specifically tied into the main structural support, you should consult a professional Structural Engineer with experience in this type of application.
- **PROPER DRAINAGE.** It is extremely important to have in place measures to sufficiently handle excessive water spillage. Be sure the flooring in which the spa rests on has adequate drainage and can handle draining of the entire contents of the spa. Be sure to make provisions for ceilings or any other structures that may be below the spas installation. Areas around your spa can become wet or moist so all flooring and subsequent furniture, walls and adjacent structures should be able to withstand or resist water and moisture.
- **PROPER VENTILATION.** Proper ventilation should be discussed with an Engineer or authority competent enough to understand the necessary provisions needed to vent moist or heated air and air associated with chemical odors outdoors. When the spa is in use considerable amounts of moisture will escape potentially causing mold and mildew, over time this can damage certain surfaces and or surroundings.
- **SUFFICIENT ACCESS.** In the unlikely event that you should ever need to access or gain entry to any portion of the spa for servicing, it is highly recommended that you plan your indoor installation to provide full access to the entire spa.
- **WARRANTY.** Damage caused by not following these guidelines or any improper installation not in accordance with local codes or authorities is not covered under the spas warranty. Please consult your local state or city building ordinances.



WARNING: In addition to maintenance of filters and water chemistry, proper ventilation is recommended to reduce the risk of exposure to viruses and bacteria that could be present in the air or water. Consult a licensed architect or building contractor to determine your specific needs if installing your spa indoors.

5.0 Power Requirements

Sundance® spas are designed to provide optimum performance and flexibility of use when connected to the maximum electrical service listed on pages 10-12. If you prefer, your dealer can perform a minor circuit board modification to allow your spa to accept an electrical service other than the factory setting.

Note: Refer to pages 40-45 for circuit board configuration details or contact your authorized Sundance dealer.

5.1 North American 60 Hz Power Options

North American Denali/Tacoma 1-Pump Convertible Models (60 Hz)

	<u>120V/15A*</u>	<u>240V/30A*</u>	<u>240V/40A**</u>
Voltage:	120 VAC	240 VAC	240 VAC
# of Wires:	3 (15A GFCI Cord - US Models Only*)	4 (Hard Wired Only)	4 (Hard Wired Only)
Frequency:	60 Hz	60 Hz	60 Hz
Current Draw:	12A	21A	30A
Circuit Breaker:	15A, 1-Pole	30A, 2-Pole	40A, 2-Pole

CAUTION (For 4-wire, 240 VAC Heater Operation): Move the red wire on the main terminal strip (TB1) from position #1 to position #3. Make certain wires are connected exactly as shown in Figure D (page 15) before applying power. Failure to do so will result in damage to the circuit board and/or related components and void the manufacturer's warranty.

* In the 15A/30A configuration, the heater **will not operate** at the same time as the high-speed jets pump. **The factory setting is 120V/15A.**
Note: all Canadian spas must be hard wired (120 VAC or 240 VAC) per CSA Canadian standards (page 4).

** If the spa is to be operated on 40A service, remove the jumper JP1 #1-2 on the circuit board to allow the heater to operate at the same time as the high-speed jets pump (page 40).

North American Burlington 1-Pump Models (60 Hz)

	<u>240V/40A*</u>	<u>240V/50A**</u>
Voltage:	240 VAC	240 VAC
# of Wires:	3	3
Frequency:	60 Hz	60 Hz
Current Draw:	26A	36A
Circuit Breaker:	40A, 2-Pole	50A, 2-Pole

* In the 40A configuration, the heater **will not operate** while the jets pump is running in high speed.

** In the 50A configuration, the heater **will operate** while the jets pump is running in high speed. **This is the factory setting.**

North American Hartford and Hawthorne 2-Pump Models (60 Hz)

	<u>240V/40A*</u>	<u>240V/50A**</u>	<u>240V/60A***</u>
Voltage:	240 VAC	240 VAC	240 VAC
# of Wires:	3	3	3
Frequency:	60 Hz	60 Hz	60 Hz
Current Draw:	26A	36A	45A
Circuit Breaker:	40A, 2-Pole	50A, 2-Pole	60A, 2-Pole

* In 40A configuration, the heater **will not operate** while either jets pump is running in high speed. **Note: pump 2 runs only in high speed.**

** In 50A configuration, the heater **will not operate** while both jets pumps are running in high speed. **Note: pump 2 runs only in high speed. This is the factory setting.**

*** In 60A configuration, the heater **will operate** while both jets pumps are running in high speed. **Note: pump 2 runs only in high speed.**

5.2 Export 50 Hz Power Options

Export Burlington, Denali and Tacoma 1-Pump Models (50 Hz)

	<u>230V/20A*</u>	<u>230V/30A**</u>
Voltage:	230 VAC	230 VAC
# of Wires:	3	3
Frequency:	50 Hz	50 Hz
Current Draw:	15A	21A
Circuit Breaker:	20A	30A

* In the 20A configuration, the heater **will not operate** while the jets pump is running in high speed. **This is the factory setting.**

** In the 30A configuration, the heater **will operate** while the jets pump is running in high speed.

Export Hartford and Hawthorne 2-Pump Models (50 Hz)

	<u>230V/20A*</u>	<u>230V/30A**</u>	<u>230V/40A***</u>
Voltage:	230 VAC	230 VAC	230 VAC
# of Wires:	3	3	3
Frequency:	50 Hz	50 Hz	50 Hz
Current Draw:	15A	23A	29A
Circuit Breaker:	20A	30A	40A

* In the 20A configuration, the heater **will not operate** while either jets pump is running in high speed. **This is the factory setting.**

** In the 30A configuration, the heater **will not operate** while both jets pumps are running in high speed.

*** In the 40A configuration, the heater **will operate** while both jets pumps are running in high speed.

6.0 Electrical Wiring Instructions

IMPORTANT NOTICE: The electrical wiring of this spa must meet the requirements of the National Electrical Code/USA (NEC) and any applicable state or local codes. The electrical circuit must be installed by a qualified electrician and approved by a local building/electrical inspection authority.

1. **Convertible 120/240V Denali/Tacoma Models Only:**
 - 120V “Plug-in” Operation: This spa must operate on the supplied 10 foot (3m) 120V GFCI cord at its original length or must be hard-wired for longer runs. **NEVER USE AN EXTENSION CORD FOR ANY REASON!**
 - Convertible 120/240V Heater Operation: The included 120V GFCI cord must be discarded for 240V heater operation. This spa must be hard-wired. Supplying power to either configuration above which is not in accordance with these instructions will void both the independent testing agency listing and the manufacturer’s warranty.

2. **Dedicated 240V Burlington, Hartford and Hawthorne Models:**

This spa must be permanently connected (hard-wired) to the power supply. No plug-in connections or extension cords are to be used in conjunction with the operation of this spa. Supplying power to the spa which is not in accordance with these instructions will void both the independent testing agency listing and the manufacturer’s warranty.

3. The power supplied to this spa must be a dedicated circuit with no other appliances or lights sharing the power provided by the circuit.

4. To determine the current, voltage and wire size required, refer to Section 5.0 “Power Requirements” (pages 10-12).
 - Wire size must be appropriate per NEC and/or local codes.
 - We recommend type THHN wire.
 - All wiring must be copper to ensure proper connections. **Do not use aluminum wire.**
 - When using wire larger than #6 (10 mm²), add a junction box near the spa and reduce to short lengths of #8 (8.4 mm²) wire to connect to the spa.

5. The electrical supply for this product must include a suitably rated switch or circuit breaker to open all ungrounded supply conductors to comply with Section 422-20 of the National Electrical Code/USA, ANSI/NFPA 70. The disconnecting means must be readily accessible to the spa's occupant but installed at least 5 feet (1.5m) from spa water.
6. The electrical circuit supplied for the spa must include a suitable ground fault circuit interrupter (GFCI) as required by NEC Article 680-42.
7. To gain access to the spa's power terminal block, remove the screws securing the cabinet panel on the side of the spa under the control panel. Then remove the four control box door screws and door (Figure A-B, pages 14-15).
8. Select the power supply inlet you want to use (Figure A, page 14). Feed power cable to control box, then install it through the large opening provided in the bottom side of the box.
9. Connect wires, color to color, on terminal blocks TB1 and TB3 (Figures C-F, page 15). **TIGHTEN SECURELY!** All wires must be hooked up securely or damage could result.
10. Install control box door and screws and reinstall the cabinet side panels.

**Figure A
Equipment Area**

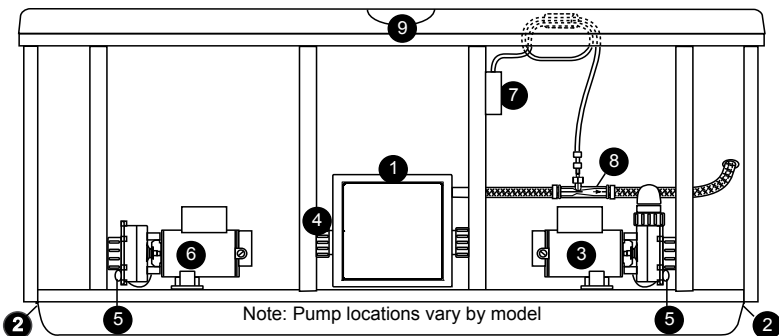

- | | |
|--------------------------|--|
| 1. Control Box | 7. Optional CD Ozonator (Purchased separately on North American models; standard equipment on export models) |
| 2. Power Supply Inlet(s) | 8. Ozone Injector |
| 3. 2-Speed Pump #1 | 9. Control Panel |
| 4. Heater | |
| 5. Pump Drain Plugs | |
| 6. 1-Speed Pump #2 | |

Figure B
Control Box

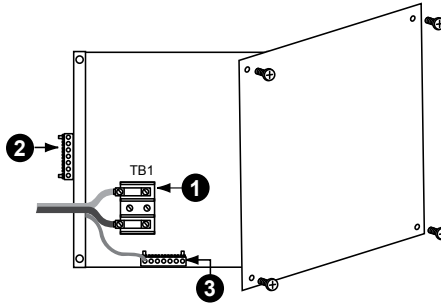

1. Terminal Block
2. Bonding Lug
3. Grounding Terminal

Figure C

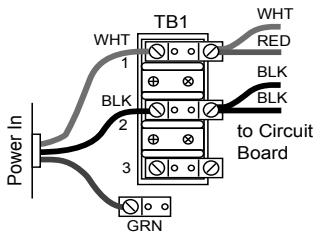

North American Denali/Tacoma Convertible Models: 120 VAC, 3-Wire Connection (60 Hz)

Figure D

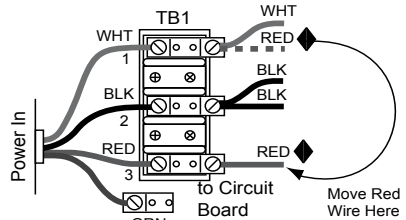

North American Denali/Tacoma Convertible Models: 120/240 VAC, 4-Wire Connection (60 Hz)

◆ **CAUTION (For 4-wire 240 VAC Heater Operation):** Move the red wire on the main terminal strip (TB1) from position #1 to position #3. Make certain wires are connected exactly as shown in Figure D before applying power. Failure to do so will result in damage to the circuit board and/or related components and void the manufacturer's warranty.

Figure E

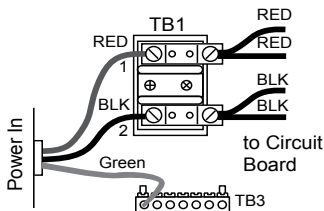

North American Burlington, Hartford and Hawthorne Models: 240 VAC, 3-Wire Connection (60 Hz)

Figure F

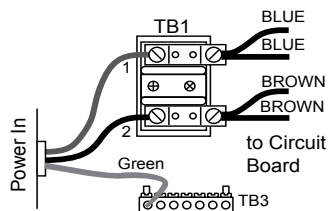

All Export Models: 230 VAC, 3-Wire (50 Hz)

7.0 Spa Fill Up Procedure

FOR BEST RESULTS, READ EACH STEP IN ITS ENTIRETY BEFORE PROCEEDING WITH THAT STEP.

1. Prepare The Spa For Filling

- Clear all debris from the spa. (Although the spa shell has been polished at the factory, you may want to treat it with a specially formulated spa cleaner.) Consult your authorized Sundance dealer for additional information prior to filling spa.
- Remove filter/skimmer lid (page 22), then remove filter cartridge as outlined in Section 11.1 (page 30).

2. Fill Spa

- Place the end of your garden hose into the empty filter bucket.



CAUTION: Never fill with water from a water softener. If your water is extremely “hard”, it is preferable to fill half-way with hard water and the rest of the way with softened water. Or, you may fill entirely with hard water if you use a special water additive available from your authorized Sundance dealer.

- Fill spa with clean tap water from garden hose until water covers all jets (DO NOT OVERFILL!).



IMPORTANT: Always fill your spa through the filter bucket after draining. Failure to do so may cause air to be trapped in either pump, preventing the pump from circulating water. Remove the hose and replace the filter cartridge. Note: DO NOT overtighten filter cartridge, finger tight only!

3. Turn On Power

Turn on power to spa at the home's circuit breaker to start boot up sequence (Section 9.0, page 23). The heater and filter pump will automatically activate after several seconds. If the control panel LED flashes water temperature and “COOL” or “ICE” this is normal, refer to page 37 for additional information.

4. Activate Jets Pumps

Turn on all jet(s) pumps to ensure proper mixing when adding start-up chemical in step 5.

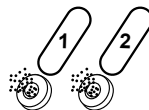

5. Add Start-Up Chemicals

Add the spa water chemicals as recommended by your authorized Sundance dealer. See Section titled “Water Quality Maintenance” (page 34) for general guidance.

6. Establish A Stable Sanitizer Reading



Establish a stable sanitizer reading between 3.0-4.0 ppm chlorine or 2.0-4.0 ppm bromine. To ensure healthy water conditions, always maintain a constant sanitizer reading within the levels recommended by the Association of Pool And Spa Professionals/USA printed on the inside cover of this manual. If sanitizer levels cannot be stabilized, perform the decontamination procedure steps 9-15 on the following page.

Note: The “decontamination procedure” steps 9-15 should also be used after the spa has been “Winterized” (Section 11.7, page 33) or has been sitting without power for an extended period.

7. Set Spa To Heat

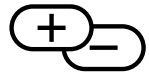
To warm spa water to a comfortable temperature, follow these steps:



- The LED display on the control panel displays the actual temperature of the spa water. Press either the COOLER () or WARMER () button once to display the “set” temperature for 5 seconds. If you want the water to heat to a different temperature, simply press COOLER or WARMER within 5 seconds. The set temperature increases or decreases by one degree each time one of these buttons is pressed.
- The heater will turn off when the temperature corresponding to the thermostat setting is achieved.

Important Heater Details:

- The maximum temperature for which the spa can be set is 104°F (40°C) and the minimum is 65°F (18°C).
- For North American (60 Hz) 2-pump spas powered by a 40 amp service, jets pump #1 must be set to low speed and jets pump #2 must be turned off to operate the heater.
- For Export (50 Hz) 2-pump spas powered by a 20 amp service, jet pump #1 must be set to low speed and jets pump #2 must be turned off to operate the heater.
- Setting the thermostat at maximum will not accelerate the heating process. This will only result in a higher ultimate temperature.
- The heater operates until the water reaches the programmed “set temperature”, then turns off. The heater will reactivate after the water cools to approximately 1.5° below the “set temperature.”

8. Place Cover On Spa

- Keeping the insulating cover in place anytime the spa is not in use will reduce the time required for heating, thereby minimizing operating costs.
- The time required for initial heat-up will vary depending on the starting water temperature.



DANGER: Risk of injury, always check water temperature carefully before entering spa!

Decontamination Procedure (Steps 9-15)

Steps 9-15 below are only required when sanitizer levels are unstable after performing steps 1-6 above. Disregard steps 9-15 below if sanitizer levels remain stable at 3.0-4.0 ppm chlorine or 2.0-4.0 ppm bromine after performing steps 1-6 above.

9. Add 2.5 ounces (71 g) of sodium dichlor for every 100 gallons (378 Liters) of water. Refer to the table below for approximate water fill volume by model.



CAUTION: Never add chlorine tablets (trichlor) to your spa for any reason! This chemical may damage components within your spa and void the manufacturer warranty.

Water Fill Volume by Model

Spa Model	Approximate Fill Volume	Sodium dichlor
Denali	298 US Gallons (1,128 Liters).....	7.5 oz.
Tacoma	186 US Gallons (704 Liters).....	4.7 oz.
Burlington	435 US Gallons (1,647 Liters).....	11.0 oz.
Hartford.....	470 US Gallons (1,779 Liters).....	11.8 oz.
Hawthorne	400 US Gallons (1,514 Liters).....	10.0 oz.

10. Leave spa cover open during this step to allow excessive chemical vapors to exit spa, protecting plastic knobs and pillows on Burlington, Hartford, Hawthorne and Tacoma models from chemical attack. If spa is indoors, open doors and windows for proper ventilation. Turn on all spa jets pumps for one hour, open all air controls. On Burlington, Hartford and Hawthorne (Figure A) and Denali (Figure B) models, place the Massage Selector or Diverter Jet in their center “combo” position as shown (right).

Massage Selector

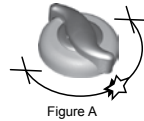

Figure A



Figure B



Set all air controls to their full open counterclockwise position

Note: You will need to press the jets pump button(s) every 20 minutes since these functions have an automatic 20 minute time-out function that turns them off.



CAUTION: Never leave your spa unattended for any reason while the cover is open and accessible to small children and animals!

11. Turn off power to the spa at the circuit breaker, then drain spa as outlined in Section 11.2 (page 31).
12. Refill spa with clean tap water from garden hose until water covers all jets (DO NOT OVERFILL!)



CAUTION: Never fill with water from a water softener. If your water is extremely “hard”, it is preferable to fill half-way with hard water and the rest of the way with softened water. Or, you may fill entirely with hard water if you use a special water additive available from your authorized Sundance dealer.

13. Consult your authorized Sundance dealer for chemical recommendations, then add chemicals to spa water to achieve a constant sanitizer reading within the levels recommended by the Association of Pool And Spa Professionals/USA printed on the inside cover of this manual.
14. Turn on all jet pumps when adding chemicals to ensure proper mixing and leave your spa cover open until the sanitizer level falls below 4.0 ppm to protect plastic knobs and pillows from chemical attack.



CAUTION: Never leave your spa unattended for any reason while the cover is open and accessible to small children and animals.



CAUTION: To prevent the unlikely possibility of contracting a waterborne illness, maintain water chemistry within step 6 parameters. If you or other bathers experience such a condition, discontinue use and seek medical attention.

15. Establish a sanitizer reading between 3.0-4.0 ppm chlorine or 2.0- 4.0 ppm bromine, then allow the spa to set undisturbed for 8 hours. Retest water after 8 hours to determine if sanitizer levels are stable. If sanitizer levels are stable, your spa is ready for use. To ensure healthy water conditions, always maintain a constant sanitizer reading within the levels recommended by the Association of Pool And Spa Professionals/USA printed on the inside cover of this manual. If sanitizer levels are not stable at this time, it will be necessary to repeat this procedure in its entirety (steps 1-15) until stable sanitizer readings are achieved.
16. After adequate sanitizer levels are achieved, close all spa air controls by rotating them clockwise to maximize heat retention when spa is not in use.

8.0 Control Functions

8.1 Control Panel

A. **LED Display:** Can display current water temperature (default display), water temperature set point, selected filtration/heating mode, and error messages.

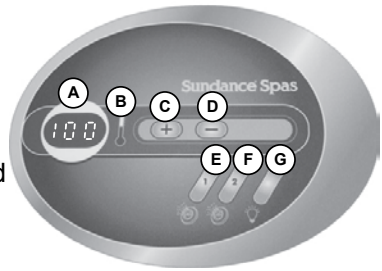

2 Pump Panel Shown

B. **Heat Indicator:** Lit when heater is on.

C. **Warmer (\oplus) Button:** Increases water temperature set point.

D. **Cooler (\ominus) Button:** Decreases water temperature set point.

E. **Jets 1 Button:** Turns jets pump #1 on and off. Press once for low speed; press a second time for high speed; press a third time to turn pump off.

F. **Jets 2 Button (Hartford and Hawthorne Models):** Turns jets pump #2 on and off. Press once for high speed; press a second time to turn pump off.

G. **Light Button:**

- Denali and Tacoma Models: Turns underwater light on in random mode or in one of six solid colors. Refer to Section 9.3 (page 24) for details.
- Burlington, Hartford and Hawthorne Models with standard Incandescent light system: Turns underwater light on and off. Refer to Section 9.4 (page 24) for details.
- Burlington, Hartford and Hawthorne Models with optional LED lighting system: Turns underwater light and top rim accent lights on in one of three random modes or one of seven solid colors. Refer to Section 9.5 (page 24) for details.

Operation Details

- Temperature Adjustment: 65 to 104°F (18 to 40°C). Factory default setting is 100°F (38°C).
- All lighting systems run for 1 hour then shut off.
- Jets 1/Jets 2 Button Operation: Jets run for 20 minutes after activated, then turn off automatically to conserve energy. Simply press either jets button to continue operation for an additional 20 minutes.

8.2 General Spa Features And Controls

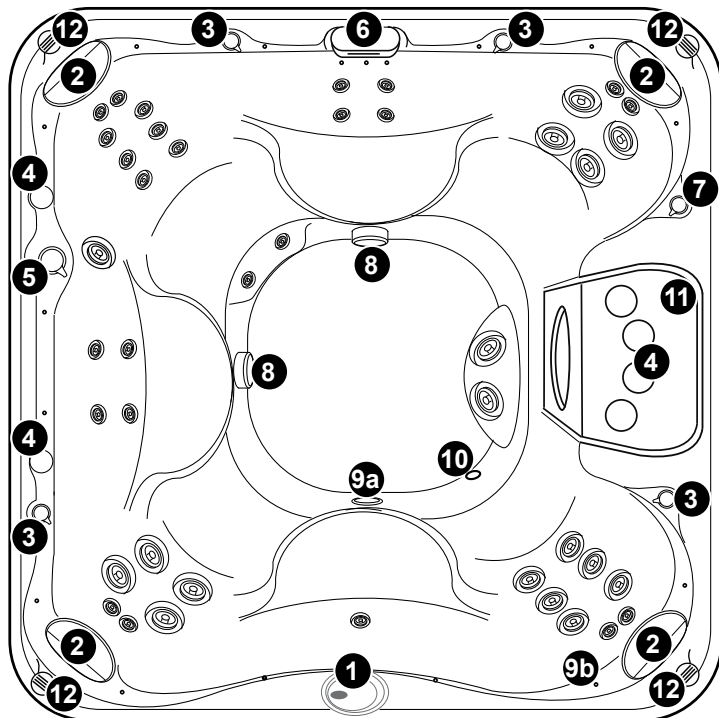







12 ↑ Hartford model illustrated - Jet locations and features will vary by model. Specifications subject to change without notice.

1. Control Panel
2. Headrest Pillows (4 ea.)
3. Air Controls (4 ea.)
4. Cup Holders (6 ea.)
5. Massage Selector (1 ea.)
6. Waterfall
7. Waterfall control valve (1 ea.)
8. Suction Fittings & Filters (Filters protect massage selector from debris entrapment/damage. Filters require periodic cleaning. (2 ea.)
9. Lighting System Options:
 - Standard Underwater light system includes incandescent light (9a).
 - Optional LED lighting system includes LED footwell light (9a) and multiple led accents lights (9b).
10. Gravity Drain: Fitting functions as floor gravity drain, heater return and optional CD ozone return.
11. Filter lid with four cup holders and two underlying filter cartridges.
 - Spas without the circulation pump option utilize both filter cartridges for jets pump 1.
 - Spas with the circulation pump option utilize one filter cartridge closest to waterfall valve (7) for jets pump 1 and the second cartridge for the 24 hour circulation pump.
12. Optional audio system speakers (4 ea.) and AM/FM/CD stereo deck (1 ea.) located on front spa skirt.



9.0 Operating Instructions

The spa control system has automatic functions that operate upon start-up and normal operation to protect the system. Upon power up, the readout displays the following information:

- | | Spa <u>with</u>
Circulation
Pump Option | Spa <u>without</u>
Circulation
Pump Option |
|--|--|---|
| 1. Control panel displays current software release (e.g. 3.56 or 5.56 depending on spa model), then; | 1.  |  |
| 2. Control panel displays "888" and all indicator LEDs are lit, permitting visual inspection of all display segments and indicator lights for proper operation. | 2.  |  |
| 3. After the initial start-up sequence ends, the actual water temperature is displayed. If water temperature at this time is less than the factory default temperature setting of 100°F (38°C) and the spa is set to either of the standard filtration/heating modes (pages 28-29), the heater will turn on and run until the water temperature rises to the factory setting, then turn off. | 3.  |  |

Note: It is common for the heater to turn on after the spa is first filled because tap water is often very cold.

9.1 Setting Water Temperature

The spa's thermostat provides optimum control of water temperature. The temperature setpoint (set temperature) can be adjusted from 65°F to 104°F (18°C to 40°C). To raise the set temperature, press the **WARMER** () button. To lower the set temperature, press the **COOLER** () button.

Note: The first press of either button displays the set temperature.

9.2 Activate Pumps

The **JETS 1** button activates the jets pump 1. The first press activates in low speed, the second press activates high speed, and the third press shuts the pump off. The **JETS 2** button (Hartford and Hawthorne models only) activates jets pump 2 which only operates in high speed. When manually activated, both pumps automatically turn off in 20 minutes.

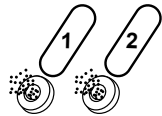

9.3 SunGlow™ Light Operation (Denali and Tacoma Models)

The spa light offers 6 constant color variations and a unique random mode for enhanced spa enjoyment. Press the Light button once to turn the spa light on in Random mode, then repeatedly press the button to turn the light off or to select one of 6 constant colors as illustrated below.

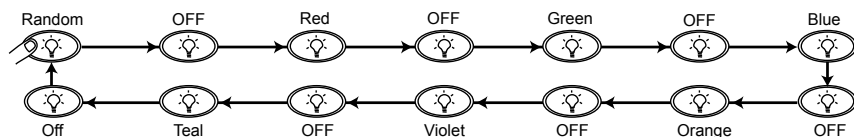

You must press the LIGHT button within 5 seconds between each “off” or “color” selection to prevent it from resetting. Pressing the button after 5 seconds restarts the sequence in Random mode. This mode automatically changes the light color every 8 to 20 seconds.

Note: Any time the spa light is manually turned on, it will automatically turn off after approximately 1 hour. If you desire more light at this time, simply turn the light back on.

9.4 Standard Light Operation (Burlington, Hartford and Hawthorne Models)

The light button activates the footwell light in the spa when pressed. Pressing the button turns the footwell light off. When manually activated, the footwell light will automatically turn off after one hour.

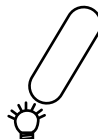

9.5 Optional Multi-Colored LED Light System Operation (Burlington, Hartford and Hawthorne Models)

The multi-colored LED spa light offers seven constant color variations and three unique random modes for enhanced spa enjoyment. Press the light button once to activate the first light mode Random Fade, then continue pressing the button to either turn the light off or to select one of seven constant colors, random solid color mode or strobe mode as illustrated below.

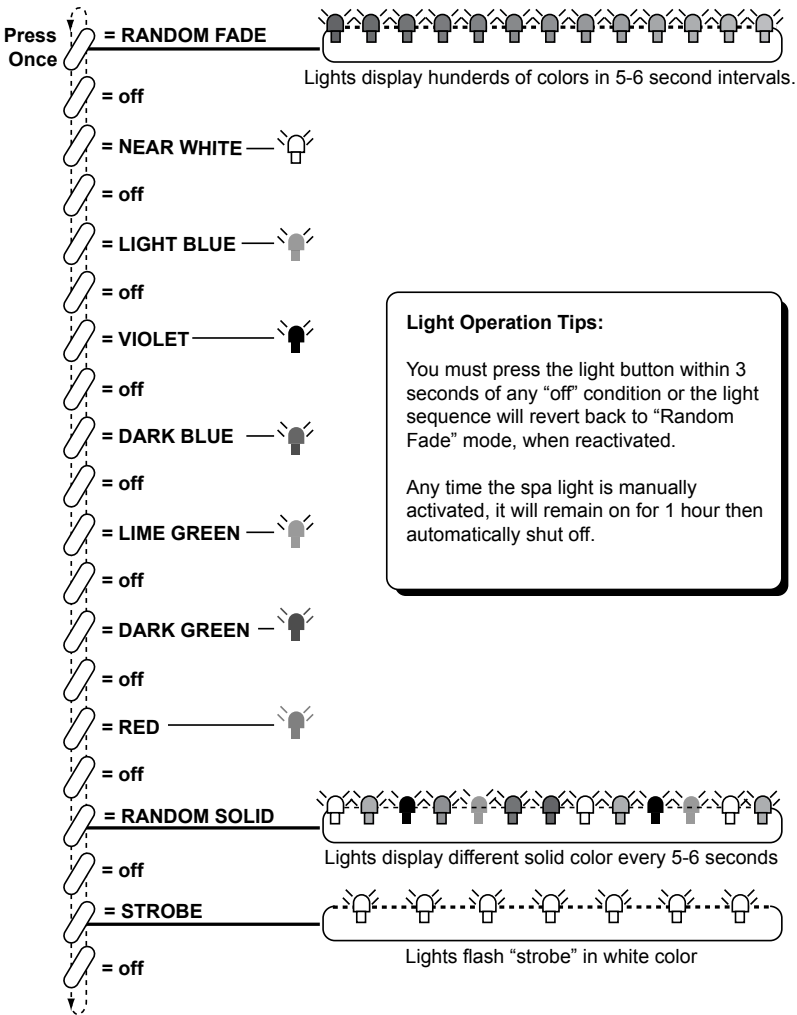

Light Operation Tips:

You must press the light button within 3 seconds of any "off" condition or the light sequence will revert back to "Random Fade" mode, when reactivated.

Any time the spa light is manually activated, it will remain on for 1 hour then automatically shut off.

9.6 Adjusting Individual Jet Flow

The water flow through individual jets in your spa can be adjusted or turned off by rotating the outside jet ring. Many jets also offer an adjustable center nozzle that allows you to change the water discharge angle. Simply tilt the center nozzle in these jets to the desired angle to customize your personal massage.



Note: Always keep at least 6 adjustable jets open at all times to ensure proper filtration characteristics within spa.

9.7 Selecting Desired Massage Action

All models (except Tacoma) incorporate a massage selector valve or Diverter Jet that allows you to customize the massage and performance by diverting water between various jet systems within the spa. Simply turn valve to positions A, B or C to divert water pressure to various jet groups.

Note: The valve is intended to operate in positions A (Combo), B, or C for optimum performance. It is considered normal for sound levels within the valve to increase between these positions due to the large amounts of water flowing through it. For optimum filtration benefits, always leave this valve in position A when the spa is covered and select positions B or C for maximum jet performance during spa use.

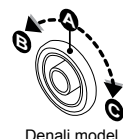
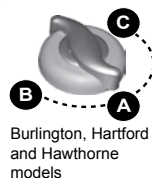

9.8 Air Controls

Certain jet systems have their own air control. Each control introduces air into the water lines that supply that specific jet group. Simply turn the air control selection to open or close. To minimize heat loss, all air controls should be closed when the spa is not in use.



9.9 Optional Audio System

Burlington, Hartford and Hawthorne models equipped with the optional audio system offer enhanced spa enjoyment. These models include a high-quality AM/FM/CD stereo receiver with four high-quality marine speakers for unsurpassed sound quality and long-life. Refer to Section 21.0 (page 46) for complete stereo operation details.



10.0 Automatic Filtration Cycles

The control system activates a programmable “standard” or “economy” filtration cycle to remove debris from your spa. These cycles use the low speed pump, skimmer basket, and filter cartridge quickly clear “skim” the water of debris and minimize their “bathtub ring” affect. Apart from their filtration benefit, each mode also effects the operation of your spa's heater. Refer to Sections 10.1-10.3 below for additional information.

10.1 Standard Filtration/Heating Modes For Models Without Circulation Pump Option

Standard filtration/heating modes (F1-F3) are typically selected by customers in cold climates where heat up times are extended due to lower ambient temperatures. In either of these modes, the water temperature is regulated by the set temperature, low-speed jets pump 1 and heater which turns on as needed. After the programmed set temperature is reached, the heater and low speed pump turn off, only to turn back on during a heat call or during the next programmed filtration/heating cycle.

10.2 Standard Filtration/Heating Modes For Models With Circulation Pump Option

Standard filtration/heating modes (F0-F3) are typically selected by customers in cold climates where heat up times are extended due to lower ambient temperatures. In either of these modes, the water temperature is regulated by the set temperature, 24 hour circulation pump and heater which turns on as needed. After the programmed set temperature is reached, the heater turns off and the circulation pump continues to operate 24 hours to filter and clean your spa.

10.3 Economy Filtration/Heating Modes (F4-F6)



Economy filtration/heating modes are typically selected by customers in warm climates where heat up times are minimized due to higher ambient temperatures. In these modes, the water temperature is regulated by the set temperature, low-speed pump, optional circulating pump and heater only while a programmed filtration/heating cycle is running.



Note: These modes consume less energy than standard modes F1-F3 outlined above.

10.4 Lock Modes (L1-L2)

These modes are designed for use during spa service or to prevent unauthorized use.

10.5 Selecting The Filtration/Heating Mode

Press and hold both control panel **WARMER** () and **COOLER** () buttons at the same time, then release.

Then press either **WARMER** () or **COOLER** () button to select filtration/heating mode F1-F6 or lock modes L1-L2 on the following pages.

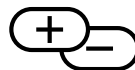

10.6 Filtration Modes for Spas Without Circulation Pump Option

If your spa is equipped with the circulation pump option, disregard this section and refer to page 29 for filter cycle programming details.

Standard Filtration/Heating Modes (F1-F3)

- F1** 4 hours of filtration/heating per day (one 2-hour cycle every 12 hours).
- F2** 6 hours of filtration/heating per day (one 2-hour cycle every 8 hours).
- F3** 8 hours of filtration/heating per day (one 2-hour cycle every 6 hours).



Economy Filtration/Heating Modes (F4-F6)

- F4** 4 hours of filtration/heating per day (one 2-hour cycle every 12 hours).
- F5** 6 hours of filtration/heating per day (one 2-hour cycle every 8 hours).
- F6** 8 hours of filtration/heating per day (one 2-hour cycle every 6 hours).



Lock Modes (L1-L2)

- L1** Lock Out (disables all spa functions to permit filter cleaning).
- L2** Lock Mode (disables the jets and light buttons to prevent unauthorized use of spa). Filtration/heating cycle will continue to operate as programmed in this mode. The temperature display flashes when this function is enable. Example: the "F3" filtration/heating cycle was enabled prior to choosing lock mode. The spa continues to perform the "F3" cycle until lock mode is canceled, allowing another cycle to be selected.



Filter Cycle Setup Example

To set a time for the first filtration/heating cycle, simply turn power on to the spa two minutes prior to the desired time. Example: If you desire your first filtration/heating cycle to begin at 10:00 AM turn off power to the spa and turn it back on again at 9:58 AM.

Note: Start time is approximate and may vary slightly from day to day.

10.7 Filtration Modes for Spas With Circulation Pump Option

If your spa is not equipped with the circulation pump option, disregard this section and refer to page 28 for filter cycle programming details.

Standard Filtration/Heating Modes (F0-F3)

(Heater automatically turns on during any heat call while in any Standard mode).

- F0** 5 minutes of filtration per day (one 5 minute “Blow-Out” cycle every 24 hours to purge all plumbing lines)
- F1** 1 hour of filtration per day (one 30-minute cycle every twelve hours); this is the factory default setting.
- F2** 1.5 hours of filtration per day (one 30-minute cycle every eight hours).
- F3** 2 hours of filtration per day (one 30-minute cycle every six hours).



Economy Filtration/Heating Modes (F4-F6)

(Heater can only turn on during an active filter cycle while in any economy mode).

- F4** 1 hour of filtration/heating per day (one 30-minute cycle every twelve hours).
- F5** 1.5 hours of filtration/heating per day (one 30-minute cycle every eight hours).
- F6** 2 hours of filtration/heating per day (one 30-minute cycle every six hours).



Lock Modes (L1-L2)

- L1** Lock Out (disables all spa functions to permit filter cleaning).
- L2** Lock Mode (disables the jets and light buttons to prevent unauthorized use of spa). Filtration/heating cycle will continue to operate as programmed in this mode. The temperature display flashes when this function is enable. Example: the “F3” filtration/heating cycle was enabled prior to choosing lock mode. The spa continues to perform the “F3” cycle until lock mode is canceled, allowing another cycle to be selected.



Filter Cycle Setup Example

To set a time for the first filtration/heating cycle, simply turn power on to the spa two minutes prior to the desired time. Example: If you desire your first filtration/heating cycle to begin at 10:00 AM turn off power to the spa and turn it back on again at 9:58 AM.

Note: Start time is approximate and may vary slightly from day to day.

11.0 Spa Maintenance

Proper and regular maintenance of your spa will help it retain its beauty and performance. Your authorized Sundance dealer can supply you with all the information, supplies, and accessory products you will need to accomplish this.



DANGER: Risk of Severe Injury or Drowning!

The suction fittings in this spa are sized to match the specific water flow created by the pump. If it is necessary to replace the suction fittings or the pump, be sure that the flow rates are compatible.

- Never operate or use the spa if the filter, filter lid, or skimmer assembly are broken or any part of the skimmer assembly is missing. Please contact your dealer or nearest service center for service.
- Never replace a suction fitting with one rated less than the flow rate marked on the original suction fitting. Using improper suction fittings can create a body or hair suction entrapment hazard that may lead to drowning or near drowning.
- Never use the spa unless all suction guards, filter, filter lid, or skimmer assembly are installed to prevent body and/or hair entrapment.
- Keep hair, loose articles of clothing or hanging jewelry away from suction fittings, rotating jets or other moving components to avoid entrapment that could lead to drowning or near drowning.

11.1 Cleaning The Filter

A. Burlington, Hartford and Hawthorne Models:

Your spa is equipped with two filter cartridges which are utilized as follows:

- Models equipped with the optional 24 hour circulation pump use cartridge 1 for the circulation pump and cartridge 2 for jets pump 1.
- Spas not equipped with the optional 24 hour circulation pump use both filter cartridges for jets pump 1.

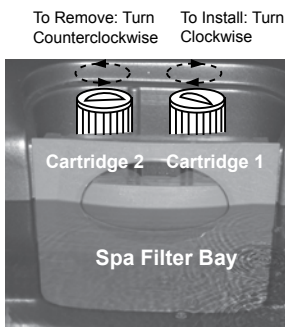

During spa use or an automatic filter cycle, water flows through the spa skimmer and into both polyester mesh filter cartridges to trap suspended particles and oils on their surface pleats. To ensure optimum performance, it is necessary to remove and clean both filter cartridges once a month or sooner depending on spa use and water quality.

B. Denali and Tacoma Models:

Your Sundance spa is equipped with a skimmer basket and filter cartridge located in the skimmer/filter well. Filtering is accomplished when the pump turns on in low speed to initiate water flow through the skimmer basket and polyester mesh filter cartridge. As this happens, suspended particles become trapped on the filter's surface. To ensure optimum performance, it is necessary to remove and clean the skimmer basket once a week and filter cartridge once a month or sooner, depending on usage and water quality.

C. Cleaning Procedure (for All Models):

1. **Turn off power to the spa at the home's breaker panel or select the L1 "Lock" mode (page 27) to disable all spa functions.**
2. Remove the filter strainer lid assembly.
3. Remove the filter cartridge by rotating it counterclockwise to unthread it from the filter wall fitting, then lift it straight up to remove from filter well.
4. Using a garden hose with a high-pressure nozzle to rinse debris from the filter pleats beginning at the top and working your way downward. Continue, one section at a time, until you have rinsed all of the filter's pleats.

Periodically, the filter cartridge will need a more thorough cleaning to remove imbedded oils and minerals. For this, we suggest cleaning as above and then soaking the cartridge overnight in a plastic container filled with a solution of water and a specially formulated filter cleanser available from your authorized Sundance dealer. The average life expectancy of a Sundance filter cartridge is approximately two years with proper care and water quality maintenance. A replacement cartridge may be purchased from your dealer.

11.2 Draining and Refilling

About every 3 months, you will want to replace the spa's water. The frequency depends on a number of variables including the amount of use, attention paid to water quality maintenance, etc. You will know it is time for a change when you cannot control sudsing and/or you can no longer get the normal feel or sparkle to the water even though the key water balance measurements are all within the proper parameters.



WARNING! READ THIS BEFORE DRAINING: To prevent damage to the spa's components, **turn off power to the spa at the circuit breaker before draining it.** Do not turn the power back on until your spa has been refilled.



CAUTION: There are certain precautions to keep in mind when draining your spa. If it is extremely cold, and the spa is outdoors, freezing could occur in the lines or the equipment (see "WINTERIZING", page 33). On the other hand, if it is hot outdoors, do not leave the spa's surface exposed to direct sunlight.

To drain your spa, perform the following steps:

1. Turn off power to spa at breaker.
2. Locate and remove the synthetic cabinet door screws and door. The door is located directly below the control panel and is easily identified by its vertical cooling slots.
3. Locate drain hose line attached to 2 x 4 wood slat (Figure A) with tie wraps.
4. Cut tie wraps and pull drain hose from equipment area (Figure B).
5. Hold drain hose above water line (Figure B), then unthread drain cap (1) from hose using a counterclockwise rotation. Place hose on ground making sure to direct water away from spa.
6. Turn valve (2) clockwise to open drain (Figure C).
7. After spa has completely drained, reinstall drain cap on drain valve finger tight! **DO NOT OVERTIGHTEN!** Close valve by turning clockwise to off position.
8. Place drain hose back inside the spa equipment bay.
9. Reinstall synthetic cabinet door and screws.
10. After refilling spa, turn on power and follow the "Spa Fill Up Procedure" (page 16).

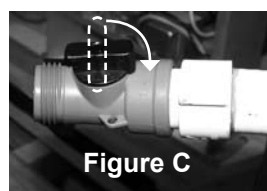
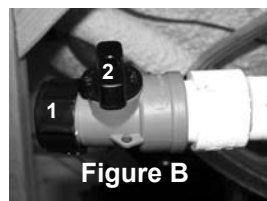
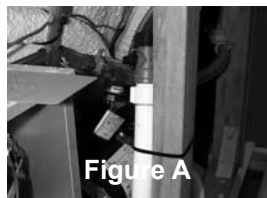

11.3 Pillow Care (All Models Except Denali)

Remove and clean the headrest pillows as needed with soapy water using a cloth or soft-bristle brush. To maintain water resistance and

luster, apply a quality vinyl conditioner once a month. Always remove the pillows when adding chemical shock treatment to the spa water. The pillows can be returned to the spa when the sanitizer reading drops below 4 ppm.

11.4 Cleaning The Spa Interior

To preserve the sheen of your spa's surface, it is crucial that you avoid using abrasive cleaners or cleaners which have adverse chemical effect on the surface. If you are not certain as to the suitability of a particular cleanser, consult your authorized Sundance dealer. Regardless of the cleanser used, use extreme care to assure that no soap residue is left on the surface. This could cause severe sudsing when the spa is refilled.

11.5 Maintaining The Cover

Using the Sundance insulating spa cover anytime the spa is not in use will significantly reduce your operating costs, heat-up time and maintenance requirements. To prolong the life of the cover, handle it with care and clean it regularly using mild soap and water. Periodic treatments with a special conditioner developed for Sundance spa covers will help protect against deterioration caused by UV rays from the sun.

Note: Never allow anyone to stand or sit on the cover, and avoid dragging it across rough surfaces.

11.6 Maintaining The Synthetic Cabinet

Your new spa's synthetic cabinet requires little or no maintenance of any kind. To clean, simply wipe cabinet with a clean towel and mild soap solution.



CAUTION: Never spray cabinet with a garden hose for any reason since this action may induce an electrical short in the spa's electrical equipment.

11.7 Winterizing

Your Sundance® spa is designed to automatically protect itself against freezing when operating properly. During periods of severe freezing temperatures, you should check periodically to be certain that the electrical supply to the spa has not been interrupted. In extreme, bitter cold weather less than -20°F (-29°C), choose the F3 "Standard" filtration/heating mode to prevent freezing (pages 28-29).

If you do not intend to use your spa, or if there is a prolonged power

outage during periods of severe freezing temperatures, it is important that all water be removed from the spa and equipment to protect against damage from freezing. **For expert winterization of your spa, contact your authorized Sundance dealer.** In emergency situations, damage can be minimized by taking the following steps:

1. Follow the directions on pages 31-32 for draining the spa.
2. As the water level drops below the seats, use whatever means necessary to get the water out of the recessed seating areas and into the footwell.
3. When the water level ceases to drop, use whatever means available to remove any remaining water from the footwell.
4. Turn off power to the spa.
5. Remove the equipment-side cabinet panel and locate the drain plugs in the front of the pump(s) (Figure A, page 14). Remove these plugs to allow the water to drain out of the pumps and heater.

Note: Approximately one to two gallons will be released during this procedure. Use a wet/dry vacuum or other means to keep this from flooding the equipment compartment. Replace the pump drain plugs.

6. Re-install cabinet side panels and cover spa so that no casual moisture can enter into it.

Consult your authorized Sundance dealer if you have any questions regarding winter use or winterizing.

11.8 Restarting Your Spa in Cold Weather

If you want to start up your spa after it has sat empty for a time in freezing temperatures, be aware that the water remaining in certain sections of the piping may still be frozen. This situation will block water flow preventing the spa from operating properly and possibly damaging the equipment. We recommend you consult your authorized Sundance dealer for guidance before attempting to re-start your spa under these conditions.

12.0 Water Quality Maintenance

Maintaining the quality of the water within specified limits will serve to enhance your enjoyment and prolong the life of the spa's equipment. It is a fairly simple task, but it requires regular attention because the water chemistry involved is a balance of several factors. There is no simple formula, and there is no avoiding it. A careless attitude in regard to water maintenance will result in poor and potentially unhealthful conditions

for soaking and even damage to your spa. For specific guidance on maintaining water quality, consult your authorized Sundance dealer who can recommend appropriate chemical products for sanitizing and maintaining your spa.



CAUTION: Never store spa chemicals inside the spa's equipment bay.

12.1 pH Control

pH is a measure of relative acidity or alkalinity of water and is measured on a scale of 0 to 14. The midpoint of 7 is said to be neutral, above which is alkaline and below which is acidic. In spa water, it is very important to maintain a slightly alkaline condition of 7.4 to 7.6 pH. Problems become proportionately severe the further outside of this range the water gets. A low pH will be corrosive to metals in the spa equipment. A high pH will cause minerals to deposit on the interior surface (scaling). In addition, the ability of the sanitation agents to keep the spa clean is severely affected as the pH moves beyond the ideal range. That is why almost all spa water test kits contain a measure for pH as well as sanitizer.

12.2 Sanitizing

To destroy bacteria and organic compounds in the spa water, a sanitizer must be used regularly. Chlorine and bromine are the two most popular sanitizers used to date. Many other additives are available for your spa. Some are necessary to compensate for out-of-balance water, some aid in cosmetic water treatment and others simply alter the feel or smell of the water. Your authorized Sundance dealer can advise you on the use of these additives.



CAUTION: Do not use chlorine tablets (trichlor) in your spa. This chemical can have an extremely corrosive effect on certain materials in the spa. Damage caused by use of this chemical, or improper use of any chemicals, is not covered under the spa's warranty.

12.3 CD Ozone Water Maintenance System

This system is optional on North American models and standard equipment on export 50 Hz spa models. If your spa is equipped with the optional Sundance CD Ozone water purification system you will find that your water stays fresh and clear with significantly less chemical sanitizer usage. You will also probably be able to go longer between complete spa drainings.

13.0 Error Conditions/Error Messages

Your spa has a self-diagnostic control system. The system will automatically display the following if a problem is detected.

13.1 Summer Logic (Spas With Circulation Pump Option)

When the actual spa water temperature reaches up to 2 °F (1 °C) above the set temperature, the spa goes into “summer logic.” The 24 hour circulation pump will turn off automatically to avoid adding additional heat to the water, eventually creating an overheat condition. This setting is not user-programmable.



Note: The summer logic does not take effect until the spa water temperature reaches 95°F (35°C). This condition is more likely in excessively hot weather. Remember, the spa’s ability to cool is directly affected by the ambient temperature. An excessively hot ambient temperature may prevent the spa from cooling down because it’s fully insulated construction is designed to retain heat and to minimize operating costs.

13.2 Panel displays SN1

Open sensor (heater is disabled) or shorted sensor (spa is deactivated). The high-limit temperature sensor is not functioning. Your authorized Sundance dealer must repair this.



13.3 Panel displays SN2

Open or shorted sensor (heater disabled). The temperature sensor is not functioning. Your authorized Sundance dealer must repair this.



13.4 Panel Flashes FL1 or FL2 (Spas Without Circulation Pump Option)

A flashing “FL1” display means the pressure switch is not closed when the jets pump 1 is activated. Proper waterflow is inhibited or the pressure switch has malfunctioned. A flashing “FL2” display means the pressure switch is malfunctioning closed. In either case, the heater is deactivated. To correct condition, perform to the following:



1. Verify water level is one inch below lowest pillow. Add water if necessary.
2. Check for clogged or excessively dirty filter cartridges (Section 11.1, page 30).
3. Purge “air lock” from jets pump 1 by loosening the upper pump head drain screw (Figure A, page 14) for a few seconds to release trapped air, then retighten drain screw. FINGER TIGHT ONLY!
4. If problem persists, contact your authorized Sundance dealer.

13.5 Panel Flashes FL1 or FL2 (Spas With Circulation Pump Option)



A flashing “FL1” display means the flow switch is malfunctioning open, the circulation pump filter cartridge 1 is excessively dirty or an “air lock” condition has occurred at the circulation pump intake. A flashing “FL2” display means the flow switch is malfunctioning closed. In either case, the spa heater will deactivate and jets pump #1 may also deactivate. To correct condition perform the following:

1. Verify water level is 1" below lowest pillow. Add water if necessary.
2. Check for clogged or excessively dirty filter cartridges (Section 11.1, page 30)
3. Purge “air lock” from circulation pump intake by removing filter cartridge 1 (page 30). Hold your garden hose over the filter cartridge 1 wall fitting (with grate) while using a rag as a seal around hose end. Ask a helper to turn on water for 30 seconds, then turn off. Reinstall filter cartridge 1 and check spa (Section 11.1, page 30).
4. If the circulation pump is not running, turn power off at the main breaker, then turn power back on. This will reset the circulation pump priming cycle. Once the pump is primed, the error should clear.
5. If problem persists, contact your authorized Sundance dealer.

13.6 Panel displays COL



Cool Condition - Temperature has dropped 20°F (11°C) below the current set temperature. The pump and heater have been activated to bring the temperature to within 15°F (8°C) of the set temperature. No corrective action is required.

Note: During cold periods, you may consider increasing the number of filtration cycles (pages 28-29).

13.7 Panel Displays ICE



Freeze Protection - A potential freeze condition has been detected. No action is required. The pump and heater will operate to circulate and warm water through the plumbing spa is out of danger. See “Winterizing” Section 11.7 for details (page 33).

13.8 Panel Displays OH



Water temperature is above acceptable limits. Do not enter spa! Water temperature has reached 112°F (44°C) and the low speed pump has activated to circulate water through heater.

13.9 Panel displays - - -

The safety “Watchdog” software has been triggered and the spa is deactivated. A problem has been detected which could cause damage to the spa or its components. Contact your authorized Sundace dealer.

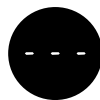

14.0 Troubleshooting Procedures

In the event your spa is not working the way it should, please first review all the installation and operating instructions in this manual and check the message on the panel display. If you are still not satisfied it is working properly, please follow the appropriate troubleshooting instructions below.

Note: If any of the supply cords to the accessories are damaged, they must be replaced by authorized service personnel.

14.1 None of the Components Operate (e.g. Pump, Light)

Check the following when none of the spa components operate (e.g. jets pumps or light):

1. Is there power to the spa?
2. Is the household circuit breaker tripped?
3. Call your authorized dealer.

14.2 Pump Does Not Operate but Light Does

Press the JETS 1 Button:

1. If no water movement is detected, make sure power is going to the spa and check the water level. If it does not solve the problem, contact your authorized Sundance dealer.
2. The main pump operates but no water flows to jets. Pump may not be properly primed. This can happen after the spa is drained and refilled. Press the JETS 1 button several times, never leaving the motor on for more than 5 to 10 seconds at a time. Turn power off and let the air out removing the filter cartridge. Refer to Section 11.1 (page 30). Make certain you reinstall the filter cartridge before turning on spa power and restarting the jets pump.

14.3 Poor Jet Action

1. Press the JETS 1 button to make certain the pump #1 is on.
2. Open all air control to the “on” position.
3. Check for dirty filter. Clean, if necessary.
4. Make sure jets are all the way open.

14.4 Water is Too Hot

Reduce thermostat setting.

14.5 No Heat

1. Check thermostat setting.
2. Keep the spa cover in place while heating.
3. Check the settings to see if your spa is in economy filtration/heating mode (pages 28-29).

Should checking the above steps fail to correct the problem, please call your dealer so that they may arrange service.

We build the best spas in the industry. Nonetheless, we are always striving to improve the quality and features of our products. Your input as a Sundance spa owner is a cherished part of this process. If you have any comments or suggestions, or if you wish to be informed on any new products for your spa, please write to us.

CONGRATULATIONS on your good taste and welcome to the happiest and most relaxed family in the world!

15.0 North American Denali/Tacoma Convertible Circuit Diagram (60 Hz)

This wiring diagram is used for all North American Denali/Tacoma 120/240 VAC (60 Hz) convertible power models.

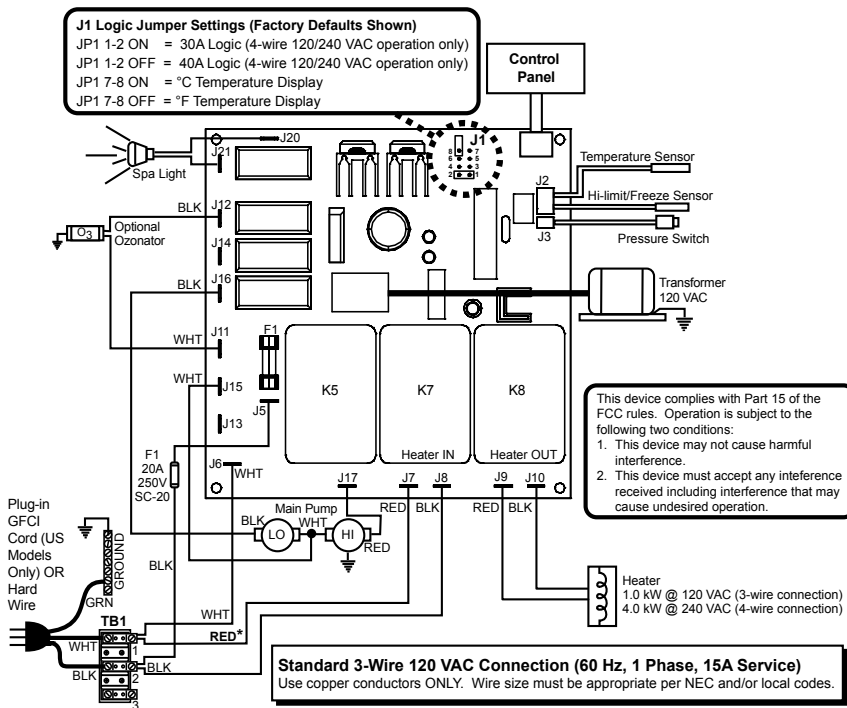

WARNING, ELECTRICAL SHOCK HAZARD EXISTS! Always remove power to spa before wiring and/or configuring the circuit board

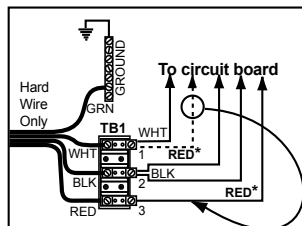

Optional 4-Wire 240/120 VAC Convertible Heater Connection

1. Remove and discard the factory installed GFCI Cord.
2. Move RED* wire from TB1 position #1 to TB1 position #3 as shown below.
3. Permanently connect to the power supply. Use copper conductors ONLY. Wire size must be appropriate per NEC and/or local codes.
4. If hot tub is to be operated on 30A service, make sure the jumper provided at location JP1 #1&2 on the circuit board is installed. If hot tub is to be operated on 40A service, remove the jumper JP1 #1&2 on the circuit board.

16.0 North American Burlington Models (60 Hz)

This wiring diagram is used for all North American Burlington models with or without the circulation pump option.

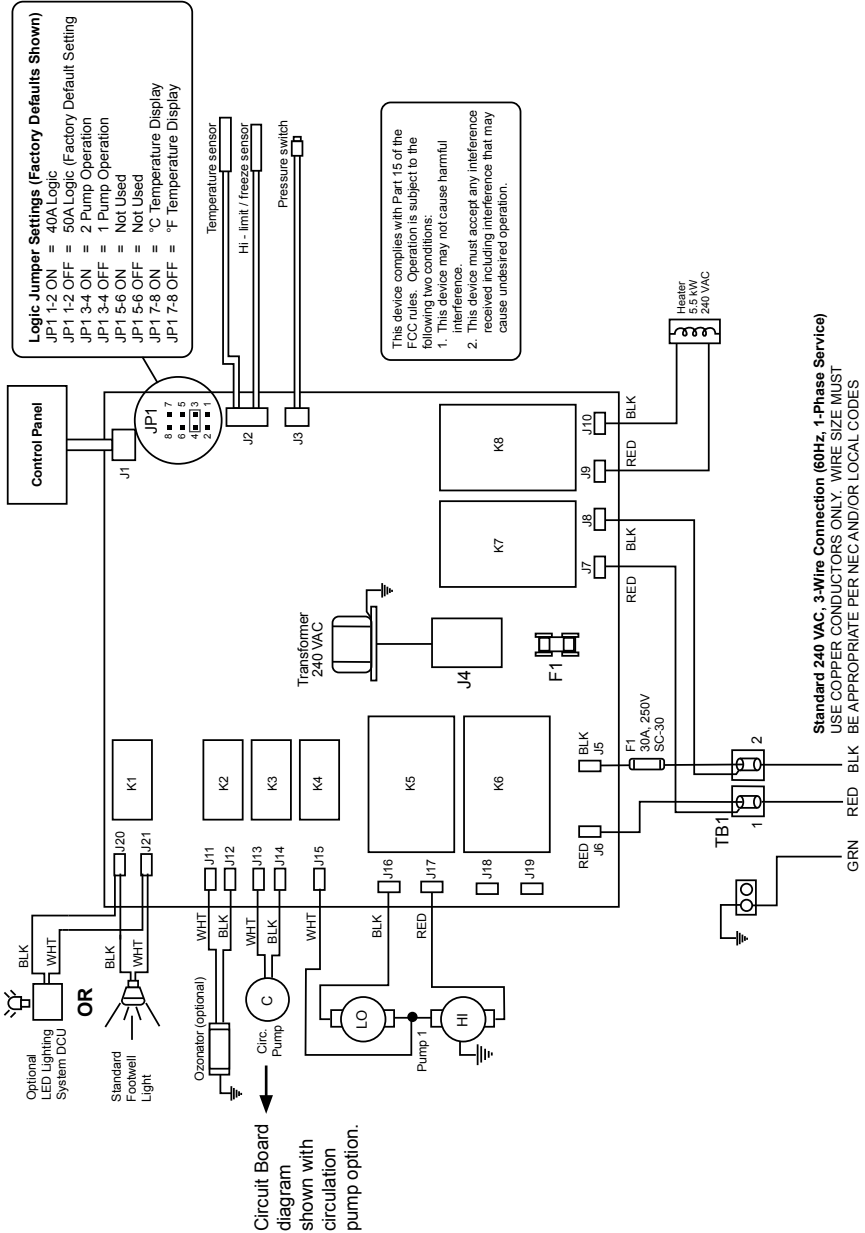

Standard 240 VAC, 3-Wire Connection (60Hz, 1-Phase Service)
 USE COPPER CONDUCTORS ONLY. WIRE SIZE MUST BE APPROPRIATE PER NEC AND/OR LOCAL CODES

Circuit Board diagram shown with circulation pump option.

17.0 North American Hartford and Hawthorne Models (60 Hz)

This wiring diagram is used for all North American Hartford and Hawthorne with or without the circulation pump option.

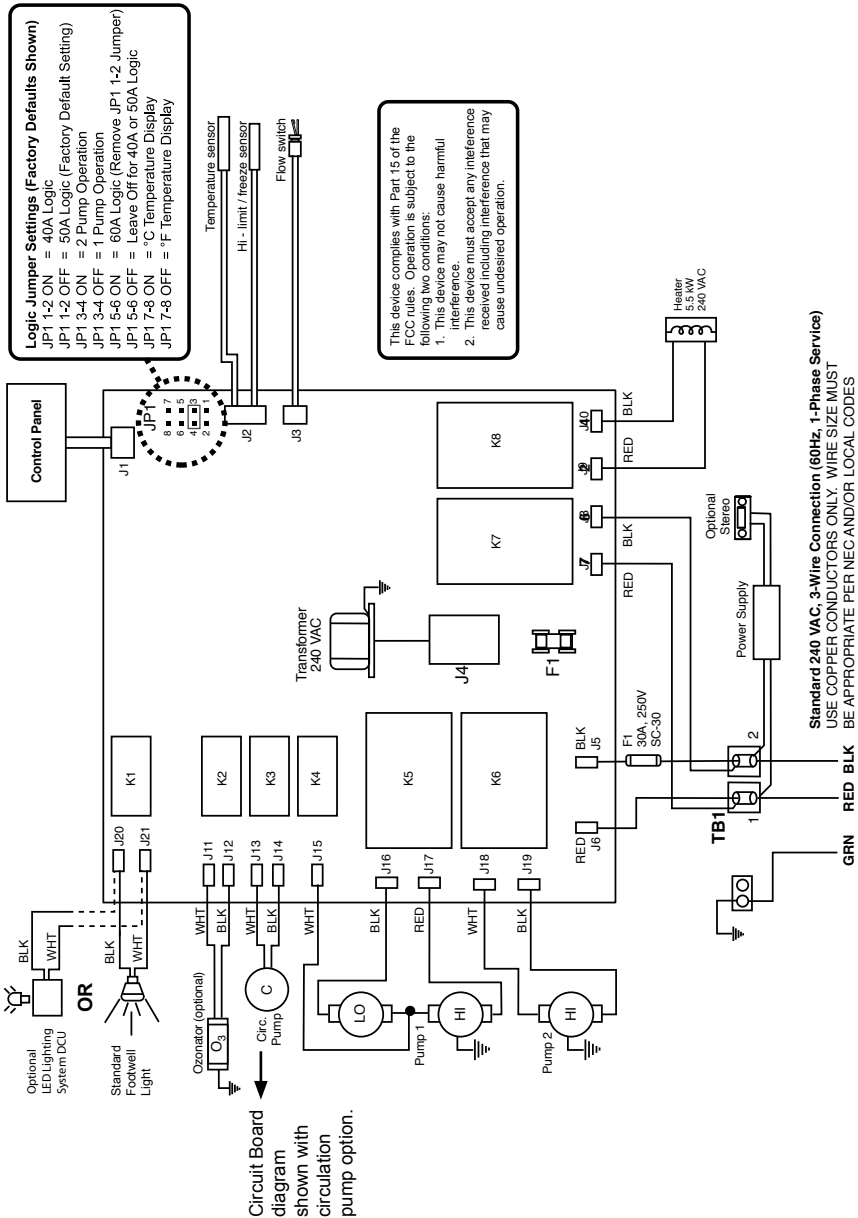

18.0 Export Denali/Tacoma Circuit Diagram (50 Hz)

This wiring diagram is used for all Export Denali/Tacoma models.

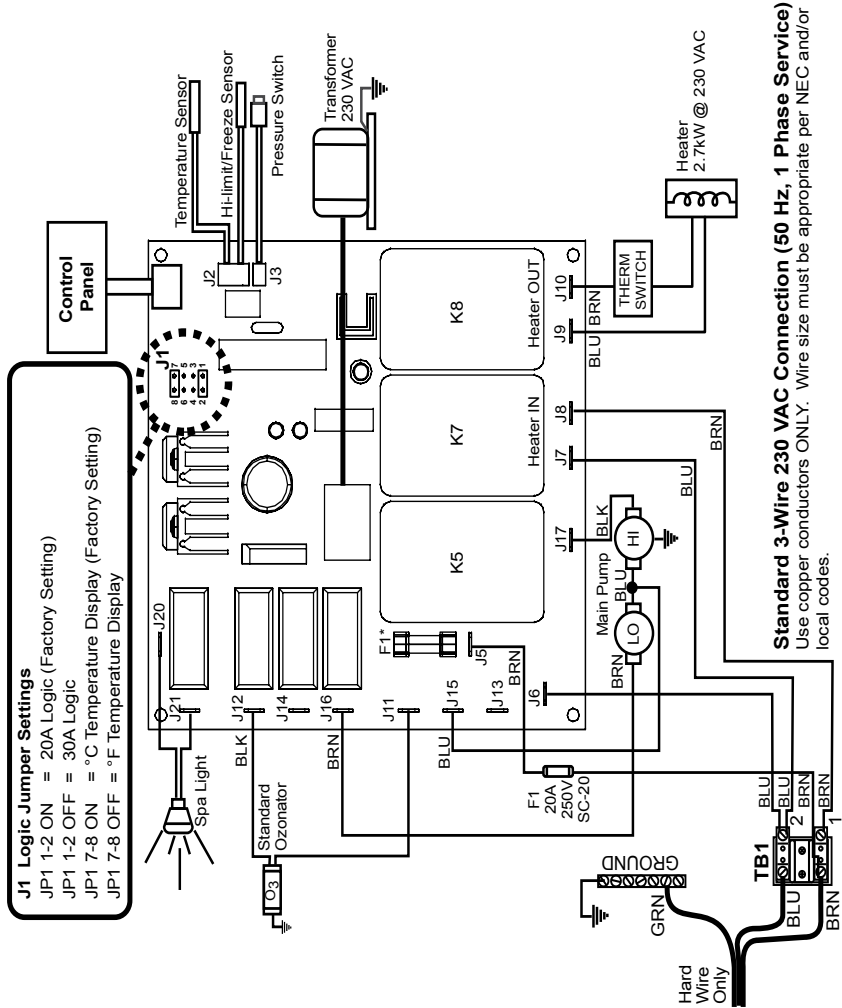

19.0 Export Burlington Circuit Diagram (50 Hz)

This wiring diagram is used for all Export Burlington models with or without the circulation pump option.

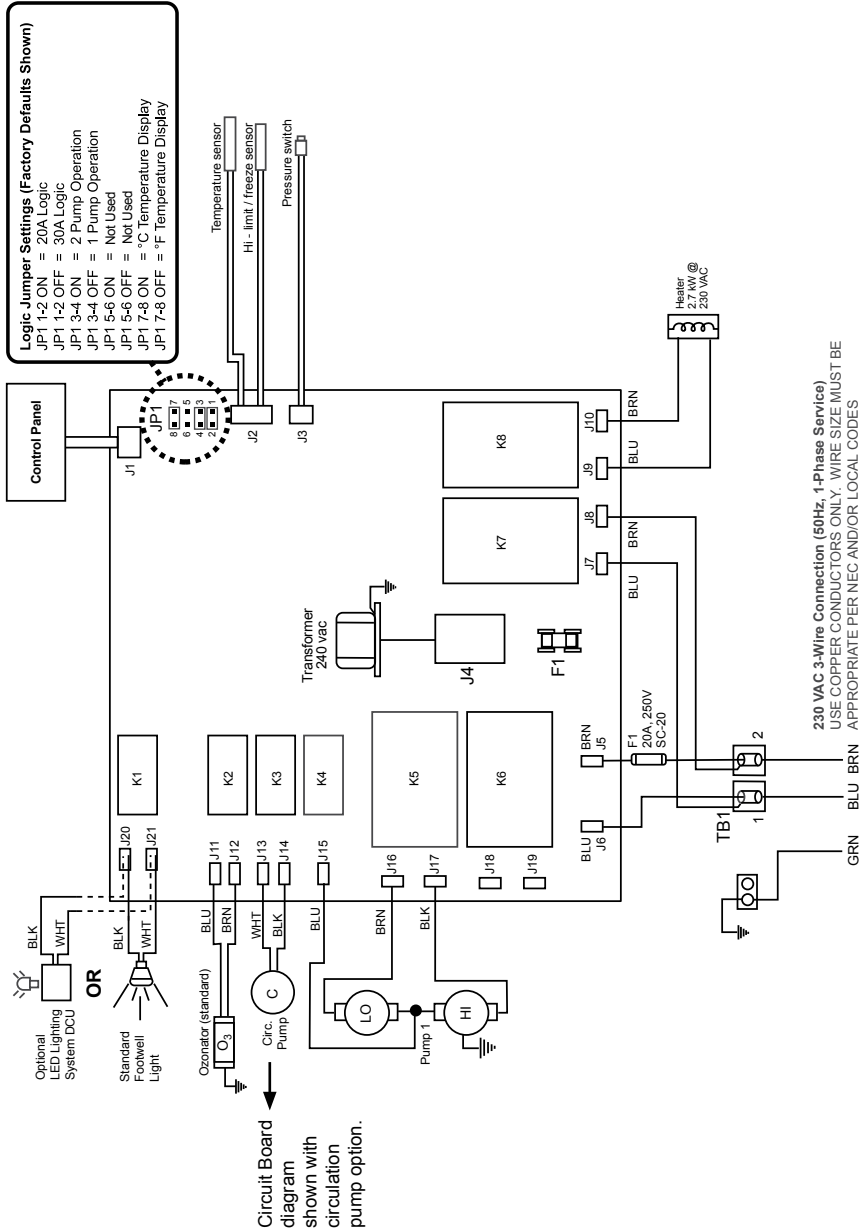

20.0 Export Hartford and Hawthorne Circuit Diagram (50 Hz)

This wiring diagram is used for all Export Hartford and Hawthorne models with or without the circulation pump option.

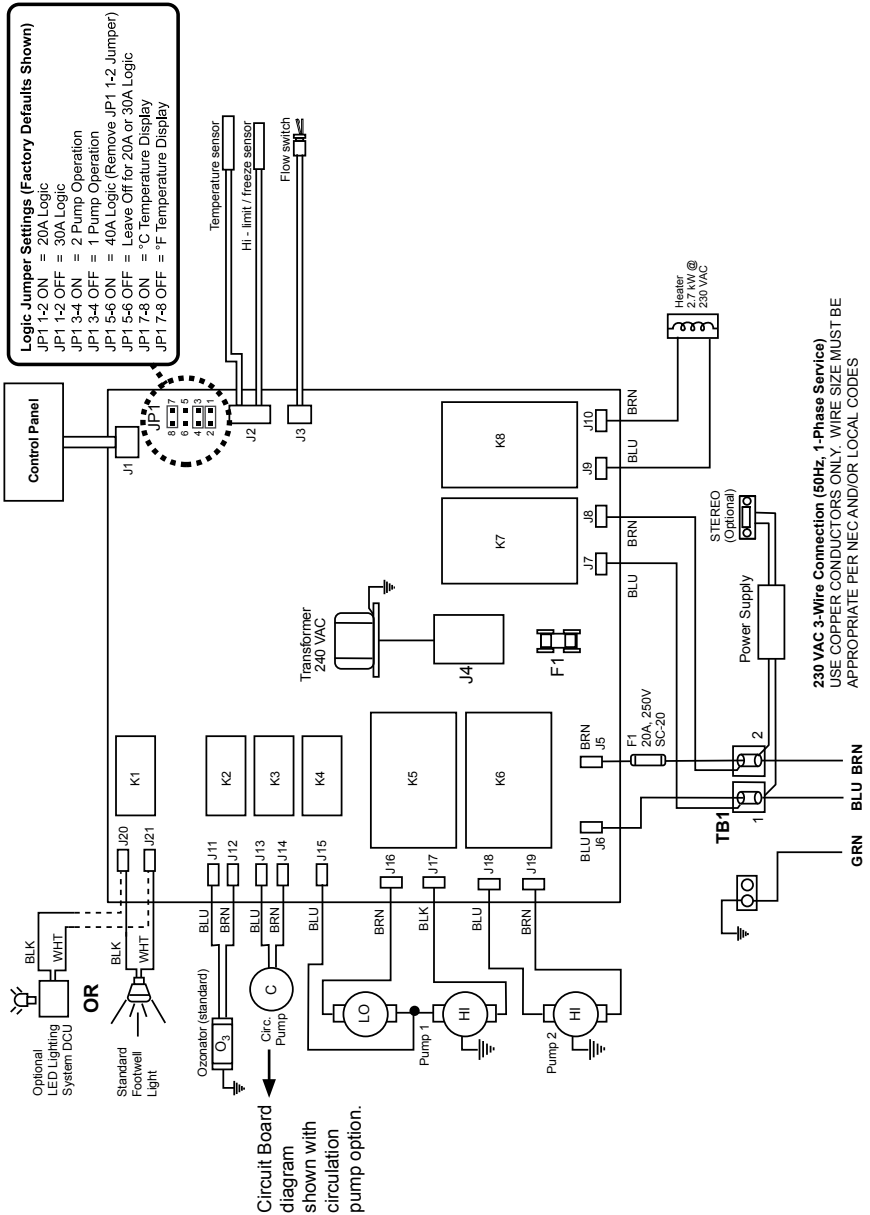

21.0 Optional SunSound™ Stereo Receiver Functions (Burlington, Hartford and Hawthorne Models Only)

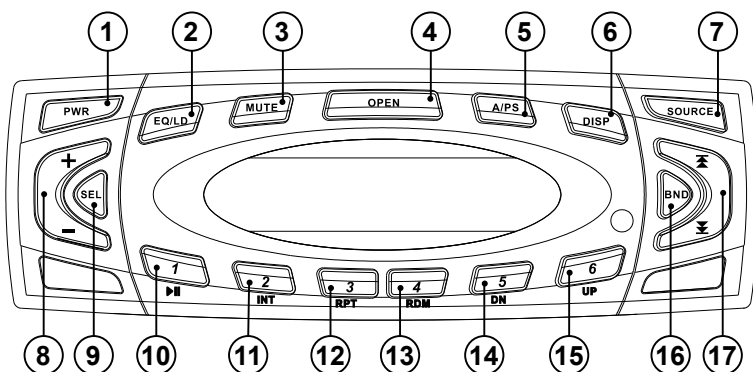

To start enjoying your new Sundance SunSound Stereo Receiver, please read the following operation instructions in their entirety.

- Power Button:** Press PWR (Power) to turn deck on or off.
- Equalization Button:** Repeatedly press EQ/LD to choose from DSP Off, Jazz, Pop, Classic, Rock or Vocal equalization options. Press and hold EQ/LD for 2 seconds to enable or disable the “LOUD” function.
- Mute Button:** Press Mute to mute audio output. Press again to return to previous volume level.
- Open Button:** Press Open to flip down the front access panel for CD access. Gently insert CD into slot, DO NOT FORCE! Make sure to close the front panel to prevent damage to the unit.
Note: Never insert a wet or moist CD since it may damage the mechanism and void the manufacturer warranty.
- A/PS Button:** Press A/PS to scan station presets. The tuner will scan up, wait for a few seconds, then continue. Once a desired station is found, press A/PS a second time to cancel scan. To automatically scan and store station presets, simply press and hold A/PS for several seconds, then release.
- DISP Button:** Press DISP to switch between clock and station frequency. When selected, the clock will display for 5 seconds then automatically revert back to station frequency.

7. **Source Button:** Press Source to change input from audio or CD mode to auxiliary mode. Press a second time to switch back.
8. **Volume Buttons:** Press + (Volume Up) or - (Volume Down) to increase or decrease volume level.
9. **SEL Button:** Press SEL to choose control function:
 - Bass
 - Treble
 - Balance
 - Fader
 - Volume

To adjust selection, press + (Volume Up) or - (Volume Down). Bass control: Adjusts the amount of low frequency. Treble control: Adjusts the amount of high frequency. Balance control adjusts the amount of sound output to the left and right speakers. Fader control adjusts the amount of sound output. You can decrease the sound level of the rear speakers by pressing + (Volume Up). To decrease the sound level of the front speakers press - (Volume Down).

Note: Bass and Treble settings are available only if EQ is set to DSP Off.

10. **Preset 1/Pause Play Button:** In tuner mode, any station can be stored as preset 1 by pressing and holding this button for 2 seconds. To recall the station preset, simply press and release this button. In CD mode pressing this button will pause or play the CD.
11. **Preset 2/INT Button:** In tuner mode, any station can be stored as preset 2 by simply pressing and holding this button for 2 seconds. To recall the station preset, simply press and release this button. In CD mode pressing this button will preview each song on the disc for about 10 seconds. Simply press again to turn off this feature.
12. **Preset 3/RPT Button:** In tuner mode, any station can be stored as preset 3 by simply pressing and holding this button for several seconds. To recall the station preset, simply press and release this button. In CD mode pressing this button will play a song repeatedly. Press again to turn off this feature.
13. **Preset 4/RDM Button:** In tuner mode, any station can be stored as preset 4 by simply pressing and holding this button for several seconds. To recall the station preset, simply press and release this button. In CD mode press this button to randomly play song tracks. Press again to turn off this feature.

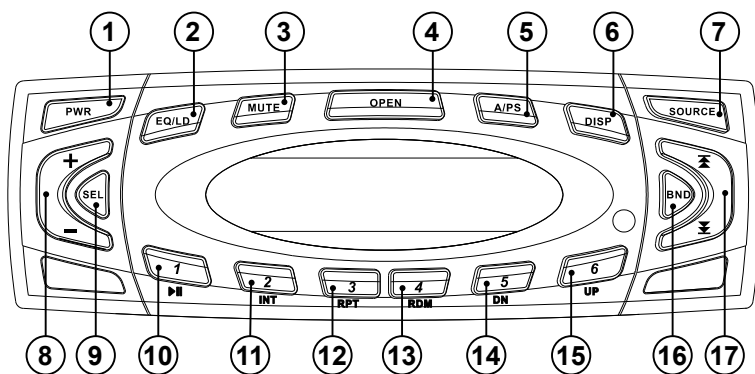

14. **Preset 5/DN Button:** In tuner mode, any station can be stored as preset 5 by simply pressing and holding this button for several seconds. To recall the station preset, simply press and release this button. In CD mode this button will browse the folders on CD-R and CD-RW disks.
15. **Preset 6/UP Button:** In tuner mode, any station can be stored as preset 6 by simply pressing and holding this button for several seconds. To recall the station preset, simply press and release this button. In CD mode this button will browse the folders on CD-R and CD-RW disks.
16. **BND Button:** Press BND to select one of the following frequency bands: FM1, FM2, FM3, AM1, AM2 and WB (weather band).
17. **Tuning UP/DOWN Buttons:** Press Track Up to manually adjust station frequency up. Press and hold Track Up to scan for next higher station. Scan mode stops as soon as a strong station is found. Press Track Down to manually adjust frequency down. Press and hold Track Down to scan for next lower station. Scan mode stops as soon as a strong station is found. In CD mode pressing these buttons will advance the CD up or down to the next or previous track. To fast forward or rewind through a track, simply press and hold either button as desired during CD playback.
18. **Reset Button (Not Illustrated):** If keys do not function at all and the unit appears to be "locked up", use a ballpoint pen to press the Reset Button under the front panel (press OPEN to flip down front panel for access). The Reset button is located directly below the Eject Button. Press to clear all memory (except station presets) and reset deck.
- Note:** This action will reset the display and clock to default settings.

19. **Eject Button (Not Illustrated):** To eject CD, press OPEN and flip-down the front access panel, then press the Eject button located to the left of CD slot.
20. **USA/Europe Switch (Not Illustrated):** You can switch between American (USA) and European radio frequency bands by flipping a switch located on the bottom of the deck. To change bands:
- 1) Power down unit
 - 2) Lift up sticker under the CD player.
 - 3) Choose desired frequency band as indicated on the sticker.
 - 4) Put sticker back in place and power up the unit.
21. **Setting The Clock (Unit Must be Off):** To set the current time, press and hold Display (6) for 3 seconds until the clock display starts to blink, then set hours using the Track Up and/or Track Down button (17). Press Display a second time to set minutes, using the Track Up and/or Track Down buttons. Press and hold Display a third time to exit clock setup (or simply wait for 5 seconds).
22. **Selecting Weather Band Mode:** Press BND (16) while in tuner mode until WB displays (deck automatically skips to the strongest weather channel) or press BND a second time to return to previous mode. When WB weather band mode is active:
- Press Track Up (17) to scan to higher weather channel.
 - Press Track Down (17) to scan to lower weather channel.
 - To save a weather channel preset, press and hold one of six numeric keys 1-6.
- Note:** Weather channel 7 is not accessible through preset key.

23. **Display information DISP:**

When a retail music CD is inserted, press DISP (6) to change modes as follows:

- Clock (displays for 5 seconds only).
- CD track no./Playtime

When a CD containing MP3 files is inserted, press DISP (6) change modes as follows:

- Clock (displays for 5 seconds only).
- Track no./Playtime
- Folder name
- File name
- Song name
- Artist's name
- Album name

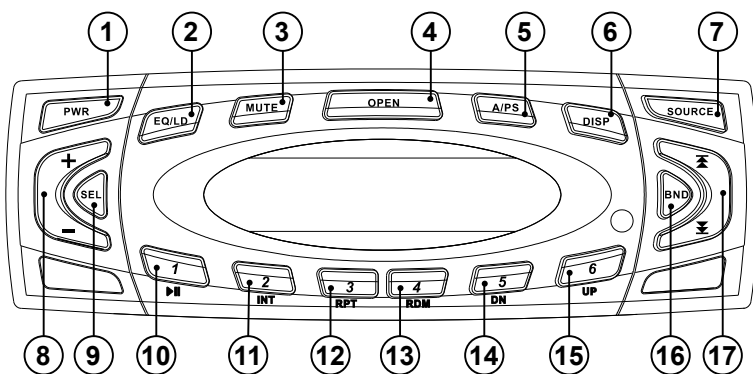

The system can only display the first 8 letters of ID3 tags. If the recorded information is longer than 8 letters, text will scroll to the left once, then the 8 first letters will be displayed. If specific info has not been recorded on an MP3 disc, NO FOLD, NO TRK, NO TLT, NO ALBM, NO ART will display.

24. Playback Order of The MP3 File:

- A directory that does not include an MP3 file is skipped.
- We recommend that you make no more than two levels for each disc.
- Maximum number of folders: 256
- Maximum number of folder levels: 8
- Maximum number of characters for MP3 file name and folder name: 32
- Sampling frequency: 16 kHz, 22.05 kHz, 24 kHz, 32 kHz, 44.1 kHz, 48kHz
- Bit rates: 8-320 Kbps
- MP3 decoding format: MPEG 1 & 2 Audio Layer 3
- Folder names and file names can be displayed with up to 8 characters (see Display key).
- The characters A-Z, 0-9 can be displayed on this unit, other characters may not be displayed correctly.
- ID3 tag is supported (see Display key).

25. Reading files into a disc: When a disc containing MP3 data is loaded, the unit checks all the data on the disc. If the disc contains numerous folders with many levels, it takes a longer time to start playback. In addition, it may take time for the unit to move to the

next MP3 file and the fast forward function may not be performed smoothly. When selected to play, files and folders are accessed in order in which they were written by the CD writer. Therefore, the playing order may not be the same as the order in which they are expected. For example, a disc with the following folder/file hierarchy is subject to folder select, file select and playback order as illustrated on page 52.

21.1 Optional SunSound™ Audio Receiver Specifications

- Marine Grade AM/FM/CD/CD-R/CD-RW/MP-3
- 7 Bands of Weather Band
- Stainless Steel Sealed Chassis and Mounting Hardware
- IPX5 Water Intrusion & CFR-46 Rated
- Conformal Coated Printed Circuit Boards
- ASTMB117 Salt Fog Tested 400 Hours
- ASTM D4329 UV Stable Tested 400 Hours
- Double Sealed Water Protection Transport Gaskets
- White Low Current/Low Heat LCD
- White Backlit Control Surfaces
- 5 Band Digital Sound Stage Settings
- 200 Watt, 50 x 4
- MP3 with ID-3 Tag, Video
- Switchable Tuner Frequency U.S. or Euro Band/CE Approved

Operation of the keys

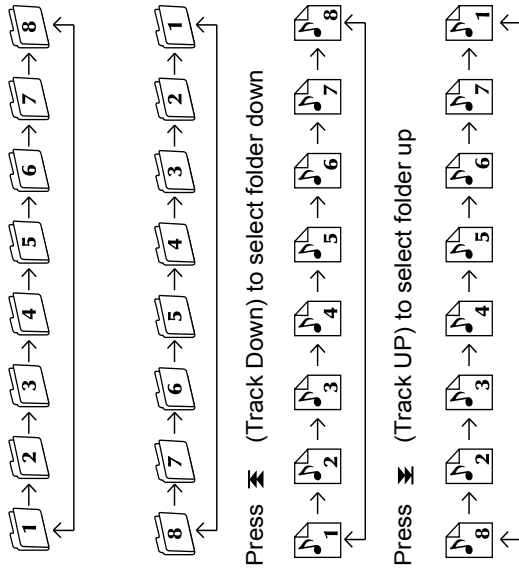

Press **⏮** (Track Down) to select folder down

Press **⏭** (Track UP) to select folder up

Press and hold **5 DN** to return 10 files behind.
 Press and hold **6 UP** to go 10 files forward.

Example of a disc's folder/file hierarchy

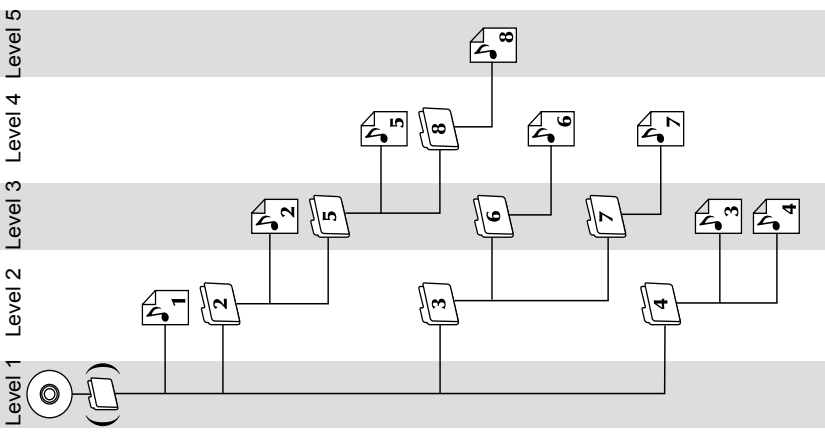

File



Folder

Notes:

680 SERIES

Notes: