

OWNER'S MANUAL

J-400™ Collection



J - 415
J - 425
J - 465
J - 470
J - 480
J - 495

2530-442A Rev. A



Attention New Spa Owner!

Congratulations on the purchase of your new Jacuzzi® spa! The following is a list of automated functions performed by your spa. These functions are listed below in an attempt to suppress any operational concerns you may have during the first 24 hours of ownership! Also listed below are important maintenance recommendations you should observe on a regular basis to protect your new investment.

Automated Spa Operations

Your new spa is equipped with an automated “clean-up” cycle that clears all plumbing lines daily to promote maximum water sanitation. Each day at 12:00 PM (noon), each pump will activate and run for one minute. If either pump has just finished a 20 minute time out, it will not automatically activate for the clean-up cycle. Be aware, the factory programmed clean-up cycle cannot be canceled or altered!

Maintain Healthy Spa Water

Always maintain your spa’s water chemistry within the following parameters:

	With CLEARRAY®	Without CLEARRAY®
pH	7.4-7.6	7.4-7.6
Free chlorine	no less than 1.0 ppm	3.0-4.0 ppm
Free bromine	no less than 2.0 ppm	2.0-4.0 ppm
Total Alkalinity	100-120 ppm	100-120 ppm
Calcium Hardness	150-250 ppm	150-250 ppm

IMPORTANT: CLEARRAY® Water Purification System is factory installed. If the CLEARRAY® system is altered or is not operating efficiently then follow the “without CLEARRAY®” water chemistry parameters as defined by the Association of Pool and Spa Professionals. CLEARRAY® requires an annual bulb replacement to properly sanitize your water.

 **TO DECREASE RISK OF INFECTION OR DISEASE!** Always maintain your spa filter as outlined below to ensure healthy spa water. Refer to pages 74-77 (Sec. 15.0) for additional information.

Required Filter Maintenance

Your new spa is equipped with an advanced water filtration system that provides unsurpassed water quality! To ensure maximum water quality at all times, you should clean the skimming filter cartridge every three months, or as necessary. See pages 74-77 (Sec. 15.0) for detailed filter cartridge cleaning instructions.

Required Water Replacement

 **TO DECREASE RISK OF INFECTION OR DISEASE!** You should replace the spa’s water every 3 months. The frequency depends on a number of variables including frequency of use, number of users and attention paid to water quality maintenance. You will know it is time for a change when you cannot control sudsing and/or you can no longer get the normal feel or sparkle to the water, even though the key water balance measurements are all within the proper parameters. See pages 82-84 (Sec. 16.0) for additional information.

Table of Contents

1.0	Important Spa Owner Information	1
2.0	FCC Notice	1
2.1	Industry Canada (IC) Information	1
3.0	Important Safety Instructions for all Spa Owners	2
3.1	Entrapment Risk	6
3.2	Hyperthermia	7
3.3	Important CSA safety instructions (Canada only)	8
4.0	Choosing a Location	8
4.1	Outdoor Location	9
4.2	Indoor Location	10
5.0	General Electrical Safety Instructions	11
6.0	Electrical Installation Instructions (240V Service)	11
7.0	Power Requirements	16
8.0	Spa Fill Up Procedure	18
9.0	Spa Features	23
9.1	J-495 Spa Features	23
9.2	J-495 Massage/Waterfall Selector Diagram	24
9.3	J-495 Air Controls Diagram	25
9.4	J-480 Spa Features	26
9.5	J-480 Massage/Waterfall Selector Diagram	27
9.6	J-480 Air Controls Diagram	28
9.7	J-470 Spa Features	29
9.8	J-470 Massage/Waterfall Selector Diagram	30
9.9	J-470 Air Controls Diagram	31
9.10	J-465 Spa Features	32
9.11	J-465 Massage/Waterfall Selector Diagram	33
9.12	J-465 Air Controls Diagram	34
9.13	J-425 Spa Features	35
9.14	J-425 Massage/Waterfall Selector Diagram	36
9.15	J-425 Air Controls Diagram	37
9.16	J-415 Spa Features	38
9.17	J-415 Massage/Waterfall Selector Diagram	39
9.18	J-415 Air Controls Diagram	40
10.0	Control Panel Main Menu	41
10.1	Control Panel	41
10.2	Main Menu Features	42
10.3	Menu Flowchart	44

10.4	Entertainment Menu Display.....	45
10.5	Bluetooth Submenu	46
10.6	AUX Submenu	47
10.7	USB Submenu	48
10.8	FM Radio Submenu	50
10.9	Adjust Audio Settings Submenu	53
11.0	Operating Instructions.....	56
11.1	J-1000™ Control Panel	56
11.2	Activate Jets Pump	56
11.3	Activate Lights	57
11.4	Adjusting Individual Jet Flow	59
11.5	Adjusting PowerPro™ MX2 Jets.....	59
11.6	Adjusting RX Jets	59
11.7	WaterColour™ Waterfall Control	59
11.8	Air Controls	59
11.9	Selecting the Desired Massage Action	60
11.10	Indicator Light	60
11.11	Optional J-1000™ Audio System	60
12.0	Programming Instructions for Settings 1 Menus.....	61
12.1	Programming the Eco-Mode Heating Mode	62
12.2	Programming the Auto-Heating Mode	62
12.3	Programmable Heating Mode.....	63
12.4	Clean-Up “Blow-Out” Cycle	66
12.5	Programming the CLEARRAY® timer	66
12.6	Setting the Check Filter Reminder.....	66
13.0	Programming Instructions for Settings 2 Menus.....	67
13.1	Programming the Primary Filter Cycle.....	68
13.2	Programming the Secondary Filter Cycle.....	69
14.0	Programming Instructions for Settings 3 Menus.....	70
14.1	Choosing the Language.....	71
14.2	Setting the Date	71
14.3	Setting the Time.....	72
14.4	Locking and Unlocking the Topside	73
15.0	Spa Maintenance.....	74
15.1	Cleaning the Filter Cartridges	74
15.2	Draining and Refilling.....	78
15.3	Cleaning the Spa Interior.....	79
15.4	Pillow Care.....	79
15.5	Maintaining the Synthetic Cabinet	80
15.6	Cleaning the Control Panel.....	80

15.7	Vinyl Cover Care and Maintenance	80
15.8	Winterizing	81
15.9	Restarting Your Spa in Cold Weather	82
16.0	Water Quality Maintenance	82
16.1	pH Control.....	83
16.2	Sanitizing	83
16.3	Other Additives	83
16.4	CLEARRAY® (Ultraviolet) Water Purification System	84
16.5	CLEARRAY® Bulb Replacement and Quartz Tube Maintenance	84
17.0	Error/Display Messages	88
18.0	Troubleshooting Procedures	92
19.0	Typical Spa Wiring Diagrams.....	94
19.1	Wiring diagram for North American 60 Hz Models Only	94
20.0	Optional Jacuzzi J-1000™ Audio System Stereo.....	95
20.1	Optional J-1000 Wireless Remote	96
20.2	J-1000 Wireless Remote Battery Replacement.....	102
20.3	J-1000 Audio System Stereo Specifications	103
20.4	Stereo Cautions	103

1.0 Important Spa Owner Information

Your Jacuzzi® spa is constructed to the highest standards and is capable of providing many years of trouble-free use. However, because heat retentive materials are utilized to insulate the spa for efficient operation, an uncovered spa surface and wall fittings directly exposed to sunlight and high temperatures for an extended period are subject to permanent damage or discoloration. Damage caused by exposing the spa to this abuse is not covered under warranty. We recommend that you always keep the spa full of water when it is exposed to direct sunlight and that you keep the Jacuzzi insulating cover in place at all times when the spa is not in use. Read and carefully follow the requirements for your spa's support base found in the Section 4.0 titled, "Choosing a Location" (page 8).

Jacuzzi® spas constantly strives to offer the finest spas available, therefore, modifications and enhancements may be made which affect the specifications, illustrations and/or instructions contained herein.

2.0 FCC Notice

This device complies with part 15 of the FCC Rules. Operation is subject to the following two conditions: (1) This device may not cause harmful interference, and (2) this device must accept any interference received, including interference that may cause undesired operation.

This equipment has been tested and found to comply with the limits for a Class B Digital Device, pursuant to Part 15 of the FCC Rules. These limits are designed to provide reasonable protection against harmful interference in a residential installation. This equipment generates, uses and can radiate radio frequency energy and, if not installed and used in accordance with the instructions, may cause harmful interference to radio communications. However, there is no guarantee that interference will not occur in a particular installation. If this equipment does cause harmful interference to radio or television reception, which can be determined by turning the equipment off and on, the user is encouraged to try to correct the interference by one or more of the following measures:

1. Rearrange or relocate the receiving antenna;
2. Increase the separation between the equipment and receiver;
3. Connect the equipment into an outlet on a circuit different from the circuit connected;
4. Consult the dealer or an experienced radio/TV technician for help. (Changes or modifications not expressly approved by the party responsible for FCC compliance could void the user's authority to operate this equipment.)

2.1 Industry Canada (IC) Information

The installer of this radio equipment must ensure that the antenna is located or pointed such that it does not emit RF field in excess of Health Canada limits for the general population; consult Safety Code 6, obtainable from Health Canada's website: www.hc-sc.gc.ca/rpb.

3.0 Important Safety Instructions for all Spa Owners

READ AND FOLLOW ALL INSTRUCTIONS CAREFULLY!

This spa was manufactured to meet the standards and specifications outlined in the “Virginia Graeme Baker Pool and Spa Safety Act” (VGB Safety Act). When installing and using this spa, basic safety precautions should always be followed, including:

1.  **DANGER: RISK OF SEVERE INJURY OR DROWNING!**
 - Extreme caution must be exercised to prevent unauthorized access by children.
 - To avoid accidents, ensure that children do not use this spa unless supervised at all times. Adult supervision is a critical safety factor in preventing children from drowning.
 - Use the straps and clip tie downs to secure the spa cover when not in use. This will help discourage unsupervised children from entering the spa. Keep the spa cover secure in high-wind conditions.
 - There is no representation that the cover, clip tie-downs, or actual locks will prevent access to the spa.

2.  **DANGER: RISK OF SEVERE INJURY OR DROWNING!**
 - Keep hair, loose articles of clothing or hanging jewelry away from suction fittings, rotating jets or other moving components to avoid entrapment that could lead to drowning or severe injury.
 - Never use the spa unless all suction guards, filter, filter lid, or skimmer assembly are installed to prevent body and/or hair entrapment.
 - Never operate or use the spa if the filter, filter lid, or skimmer assembly are broken or any part of the skimmer assembly is missing. Please contact your dealer or nearest service center for service.
 - The suction fittings and suction covers in this spa are sized to match the specific water flow created by the pump(s). If it is necessary to replace the suction fittings, suction covers or pump(s), be sure that the flow rates are compatible and are in compliance with the VGB Safety Act.
 - Never replace a suction fitting or suction cover with one rated less than the flow rate marked on the original suction fitting. Using improper suction fittings or suction covers can create a body or hair suction entrapment hazard that may lead to drowning or severe injury.

3.  **DANGER: RISK OF SEVERE INJURY FROM ELECTRIC SHOCK OR DEATH FROM ELECTROCUTION!**
 - Install the spa at least 5 feet (1.5m), from all metal surfaces. As an alternative, a spa may be installed within 5 feet of metal surfaces if each metal surface is permanently connected (bonded) by a minimum No. 8 AWG (8.4 mm²) solid copper conductor attached

to the wire connector on the grounding lug, inside the equipment compartment on the equipment box.



- A grounding wire connector is provided on this unit to connect a minimum No. 8 AWG (8.4 mm²) solid copper conductor between this unit and any metal equipment, metal enclosures of electrical equipment, metal water pipe, or conduit within 5 feet (1.5m) of the unit.
- Never permit any electrical appliance, such as a light, telephone, radio, television, etc. within 5 feet (1.5m) of a spa unless such appliances are built-in by the manufacturer.
- Never bring any electrical appliances into or near the spa.
- Never operate any electrical appliances from inside the spa or when you are wet.
- The electrical supply for this product must include a suitably rated switch or circuit breaker to open all ungrounded supply conductors to comply with Section 422-20 of the National Electrical Code/USA, ANSI/NFPA 70. The disconnecting means must be readily accessible and visible to the spa occupant but installed at least 5 feet (1.5m), from the spa.
- The electrical circuit supplied for the hot tub must include a suitable ground fault circuit interrupter (GFCI) as required by NEC Article 680-42.



4.  **WARNING: RISK OF SEVERE INJURY OR DEATH!**

- Extreme caution must be exercised to prevent diving or jumping into the spa or slipping and falling, which could result in unconsciousness, drowning, or serious injury. Remember that wet surfaces can be very slippery.
- Never stand, walk or sit on the top railing of the spa.

5.  **WARNING: RISK OF HYPERTHERMIA (OVER-HEATING) CAUSING SEVERE INJURY, BURNS, WELTS OR DEATH!**

- Water temperature in excess of 104°F (40°C) may be injurious to your health.
- Refer to Section 3.2 Hyperthermia for specific causes and symptoms of this condition.
- The water in the spa should never exceed 104°F (40°C). Water temperatures between 100°F (38°C) and 104°F (40°C) are considered safe for a healthy adult.
- Lower water temperatures are recommended for young children (children are especially sensitive to hot water) and when spa use may exceed 10 minutes.
- The Consumer Products Safety Commission/USA has stated that the water temperature in a spa should not exceed 104°F (40°C).
- Always test the spa water temperature before entering the spa. The user should measure the water temperature with an accurate thermometer since the tolerance of water temperature-regulating devices may vary as much as +/- 5°F (2°C).

6.  **WARNING: RISK OF SEVERE INJURY OR DEATH!**
- Since excessive water temperatures have a high potential for causing fetal damage during the early months of pregnancy, if pregnant or possibly pregnant, consult your physician before using a spa.
 - Pregnant or possibly pregnant women should limit spa water temperatures to 100°F (38°C).
 - Persons suffering from obesity or a medical history of heart disease, low or high blood pressure, circulatory system problems, diabetes, infectious diseases or immune deficiency syndromes should consult a physician before using a spa.
 - If you experience breathing difficulties in association with using or operating your spa, discontinue use and consult your physician.
 - Persons using medication should consult a physician before using a spa since some medication may induce drowsiness, while other medication may affect heart rate, blood pressure, and circulation.
 - Persons suffering from any condition requiring medical treatment, the elderly, or infants should consult with a physician before using a spa.
 - The use of alcohol, drugs, or medication before or during spa use may lead to unconsciousness with the possibility of drowning.
7.  **WARNING: RISK OF SEVERE INJURY OR DEATH!**
- Prolonged immersion in a spa may be injurious to your health.
 - Observe a reasonable time limit when using the spa. Exposures at higher temperatures can cause high body temperature (over-heating). Symptoms may include dizziness, nausea, fainting, drowsiness, and reduced awareness. These effects could possibly result in drowning or serious injury.
 - Never use a spa immediately following strenuous exercise. Enter and exit the spa slowly. Wet surfaces can be slippery.
8.  **WARNING: TO DECREASE RISK OF INFECTION OR DISEASE!**
- To reduce the risk of contracting a waterborne illness (e.g. an infection, bacteria or virus) and/or respiratory ailments, maintain water chemistry within the parameters listed on the inside cover of this manual and consult with a licensed engineer regarding proper ventilation if installed indoors or in an enclosed area.
 - People with infectious diseases should not use a spa to avoid water contamination, which could result in spreading infections to others.
 - Always shower before and after using your spa. Maintain water chemistry in accordance with manufacturer's instructions. Failure to do so may result in contracting a waterborne illness (e.g. an infection, bacteria or virus).

9.  **WARNING:** In addition to maintenance of filters and water chemistry, proper ventilation is recommended to reduce the risk of contracting a waterborne illness (e.g. an infection, bacteria or virus) and/or respiratory ailments that could be present in the air or water. Consult a licensed architect or building contractor to determine your specific needs if installing your hot tub indoors.
10. **CAUTION: TO DECREASE RISK OF PRODUCT DAMAGE.**
- Maintain water chemistry in accordance with manufacturer's instructions.
 - Proper chemical maintenance of spa water is necessary to maintain safe water and prevent possible damage to spa components.
11.  **WARNING: RISK OF SEVERE INJURY OR DEATH!** The appliance is not intended for use by persons (including children) with reduced physical, sensory or mental capabilities, or lack of experience or knowledge, unless they have been given supervision or instruction concerning use of the appliance by a person responsible for their safety.
12. **NOTE:** This spa is not intended nor designed to be used in a commercial or public application. The spa buyer shall determine whether there are any code restrictions on the use or installation of this spa since local code requirements vary from one locality to another.

Hot Tub Safety Literature

To ensure you have a safe and enjoyable hot tub experience, learn all you can about hot tub safety and emergency procedures. Especially useful are the brochures listed below:

- [Children Aren't Waterproof](#)
- [Pool and Spa Emergency Procedures For Infants and Children](#)
- [Layers of Protection](#)
- [The Sensible Way to Enjoy Your Spa or Hot Tub](#)

The Association of Pool and Spa Professionals publishes these brochures. To acquire a brochure:

- Ask your hot tub dealer (they may have copies)
- Go to <http://apsp.org>
- Conduct your own search on the internet
- Write to the following address:

The Association of Pool and Spa Professionals
2111 Eisenhower Avenue
Alexandria VA 22314
703.838.0083

3.1 Entrapment Risk

The Consumer Products Safety Commission/USA has reported that users of pools and spas have become entrapped (stuck) to drain and/or suction fittings causing death, drowning, or serious injury (see diagram below). This spa was manufactured to meet the standards and specifications outlined in the "Virginia Graeme Baker Pool and Spa Safety Act" (VGB Safety Act). Entrapment risk can be minimized if proper precautions are taken.



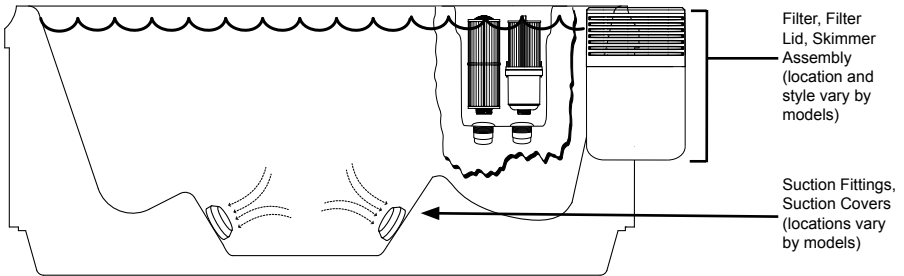

DANGER: RISK OF PERSONAL INJURY OR DEATH!

Never operate the spa if a suction fitting, suction cover, filter, filter lid or skimmer assembly are broken, damaged or missing.





Note: Suction covers must be replaced every 5 years.

1.  **DANGER: RISK OF SEVERE INJURY OR DROWNING!**
Hair entrapment: May occur if hair is entangled, knotted or snagged in a drain suction or skimmer assembly. This has been reported in persons who when submerge themselves underwater, allowing hair to come close and/or within the reach of the suction fittings, suction covers or skimmer assembly.
 - Keep hair away from suction fittings, suction covers, filter, filter lid or skimmer assembly.
 - Children are at risk for hair entrapment if swimming under water.
 - Never allow children to play or get near the suction fittings, suction covers, filter, filter lid or skimmer assembly.

2.  **DANGER: RISK OF SEVERE INJURY OR DROWNING!**
Limb entrapment: May occur when a limb becomes entrapped, inserted or sucked into a suction or outlet opening.
 - Always keep suction fittings, suction covers, filter, filter lid or skimmer assembly in place when operating to avoid limb entrapment.
 - Never allow children to play or get near the suction fittings, suction covers, filter, filter lid or skimmer assembly.

3.  **DANGER: RISK OF SEVERE INJURY OR DROWNING!**
Body entrapment: May occur when part of the torso becomes entrapped, inserted or sucked into a suction or outlet opening.
 - Never allow children to play or get near the suction fittings, suction covers, filter, filter lid or skimmer assembly.

4.  **DANGER: RISK OF SEVERE INJURY OR DROWNING!**
Evisceration (disembowelment) entrapment: May occur when the buttocks becomes entrapped, inserted or sucked into a suction or outlet opening.
 - Never sit on suction fittings, suction covers, filter, filter lid or skimmer assembly.
 - Never allow children to play or get near the suction fittings, suction covers, filter, filter lid or skimmer assembly.

5.  **DANGER: RISK OF SEVERE INJURY OR DROWNING!**
Mechanical entrapment: May occur when jewelry, swimsuit, or hair accessories become entangled, knotted or snagged in a drain suction or skimmer assembly.
 - Never allow your jewelry, swimsuit, or hair accessories to come close to the suction fittings, suction covers or skimmer assembly.
 - Never allow children to play or get near the suction fittings, suction covers, filter, filter lid or skimmer assembly.

3.2 Hyperthermia

Prolonged immersion in hot water may induce hyperthermia (overheating). The use of alcohol or drugs can greatly increase the risk of fatal hyperthermia in spas. A description of the causes, symptoms, and effects of hyperthermia are as follows:

Hyperthermia occurs when the internal temperature of the body reaches a level several degrees above the normal body temperature of 98.6°F (37°C). The symptoms of hyperthermia include drowsiness, lethargy (fatigue), and an increase in the internal temperature of the body (feeling of being too hot). The effects of hyperthermia include:

- Unawareness of impending hazard;
- Failure to perceive heat;
- Failure to recognize the need to exit spa;
- Physical inability to exit spa;
- Fetal damage in pregnant women; and
- Unconsciousness and danger of drowning.

A Warning Sign is provided in your warranty packet. Please install at a location near your spa, where it is visible to users of the spa. For additional or replacement Warning Signs please contact your local Jacuzzi dealer and reference item number #6530-082.

3.3 Important CSA safety instructions (Canada only)

When using this electrical equipment, basic safety precautions should always be followed, including the following:

1. **READ AND FOLLOW ALL INSTRUCTIONS.**
2. A green colored terminal or a terminal marked G, Gr, Ground, Grounding or the Ⓧ symbol* is located inside the supply terminal box or compartment. To reduce the risk of electric shock, this terminal must be connected to the grounding means provided in the electric supply service panel with a continuous copper wire equivalent in size to the circuit conductors that supply this equipment. *IEC Publication 417, Symbol 5019.
3. At least two lugs marked "Bonding Lugs" are provided on the external surface or on the inside of the supply terminal box/ compartment. To reduce the risk of electric shock, connect the local common bonding grid in the area of the spa to these terminals with an insulated or bare copper conductor not smaller than No. 6 AWG (10 mm²).
4. All field-installed metal components such as rails, ladders, drains or other similar hardware within 10 feet (3m) of the spa shall be bonded to the equipment grounding buss with copper conductors not smaller than No. 6 AWG (10 mm²).
5. **SAVE THESE INSTRUCTIONS.**

4.0 Choosing a Location

IMPORTANT: Because of the combined weight of the spa, water and users, it is extremely important that the base upon which the spa rests be smooth, flat, level and capable of uniformly supporting this weight, without shifting or settling, for the entire time the spa is in place. If the spa is placed on a surface which does not meet these requirements, damage to the skirt and/or the spa shell may result. Damage caused by improper support is not covered under warranty. It is the responsibility of the spa owner to assure the integrity of the support at all times. We recommend a poured, reinforced concrete slab with a minimum thickness of 4 inches (10 cm). Wood decking is also acceptable provided it is constructed so that it meets the requirements outlined above.



WARNING: For spas that are to rest on balconies, roofs or other platforms not specifically tied into main structural support, consult a professional Structural Engineer with experience in this type of application.

The spa must be installed in such a manner as to provide drainage away from it. Placing the spa in a depression without provisions for proper drainage could allow rain, overflow and other casual water to flood the equipment and create a wet condition in which it would sit in. For spas which will be recessed into a floor or deck, install so as to permit access to the equipment, either from above or below, for servicing. Make certain that there are no obstructions which would prevent removal of all side cabinet side panels and access to the jet components, especially on the side with the equipment bay.

 **CAUTION:** If the spa is indoors or located in an enclosed area, proper ventilation should be discussed with an Engineer or authority competent enough to understand the necessary provisions needed to vent moist or heated air and air associated with chemical odors outdoors. **When the spa is in use considerable amounts of moisture will escape potentially causing mold and mildew. This can cause health risk.** Over time, this can damage certain surfaces, surroundings, and equipment.

4.1 Outdoor Location

In selecting the ideal outdoor location for your spa, we suggest that you take into consideration:

- The proximity to changing area and shelter (especially in colder weather).
- The pathway to and from your spa (this should be free of debris so that dirt and leaves are not easily tracked into the spa).
- The closeness to trees and shrubbery (remember that leaves and birds could create extra work in keeping the spa clean).
- A sheltered environment (less wind and weather exposure can result in lowered operation and maintenance costs).
- The overall enhancement of your environment. It is preferable not to place the spa under an ungluttered roof overhang since run-off water will shorten the life expectancy of the spa cover.
- For spas that are to rest on balconies, roofs or other platforms not specifically tied into main structural support, consult a professional Structural Engineer with experience in this type of application.
- In the unlikely event that you should ever need to access or gain entry to any portion of the spa for servicing, it is highly recommended that you plan your outdoor installation to provide full access to the entire spa. Please take this into consideration when placing the spa in a deck or enclosed by a surrounding.
- Consider locating your spa away from any reflective surface or glass to prevent any damage to the synthetic skirt.
- Do not shim the spa. To ensure proper support the spa must sit flat on the intended foundation.

4.2 Indoor Location

For indoor installations many factors need to be considered before installing a spa indoors.



WARNING: In addition to maintenance of filters and water chemistry, proper ventilation is recommended to reduce the risk of contracting a waterborne illness (e.g. an infection, bacteria or virus) and/or respiratory ailments that could be present in the air or water. Consult a licensed architect or building contractor to determine your specific needs if installing your hot tub indoors.

- **Proper Foundation: Consult a Structural Engineer when considering a foundation that will adequately support the spa the entire time it is in place.** Proper support is critical especially if the spa is to rest on a second story or higher. For spas that are to rest on balconies, roofs or other platforms not specifically tied into the main structural support, you should consult a professional Structural Engineer with experience in this type of application.
- **Proper Drainage: It is extremely important to have in place measures to sufficiently handle excessive water spillage.** Be sure the flooring in which the spa rests on has adequate drainage and can handle the entire contents of the spa. Be sure to make provisions for ceilings and other structures that may be below the spas installation. Areas around your spa can become wet or moist so all flooring and subsequent furniture, walls and adjacent structures should be able to withstand or resist water and moisture.
- **Proper Ventilation: Proper ventilation should be discussed with an Engineer or authority competent enough to understand the necessary provisions needed to vent moist or heated air and air associated with chemical odors outdoors.** When the spa is in use considerable amounts of moisture will escape, potentially causing mold and mildew over time which can damage certain surfaces and/or surroundings.
- **Sufficient Access:** In the unlikely event that you should ever need to access or gain entry to any portion of the spa for servicing, it is highly recommended that you plan your indoor installation to provide full access to the entire spa.
- **Warranty:** Damage caused by not following these guidelines or any improper installation not in accordance to local codes or authorities is not covered under the spas warranty. Please consult your local state or city building ordinances.
- **Do not shim the spa.** To ensure proper support the spa must sit flat on the intended foundation.

5.0 General Electrical Safety Instructions

Your new Jacuzzi® spa is equipped with the J-1000™ system. It contains the most advanced safety and self-protective equipment in the industry. Nonetheless, this spa must be installed properly to ensure dependable usage.

Please contact your local Jacuzzi dealer or local building department should you have any questions regarding your installation.

Proper grounding is extremely important. Jacuzzi spas are equipped with a current collector system. A pressure wire connector is provided on the surface of the control box, located inside the equipment door (Figure B, page 13) to permit connection of a bonding wire between this point and any ground metal equipment, metal water pipe or conduit within 5 feet (1.5m) of the spa, or copper clad grounding rod buried within 5 feet (1.5m) of the spa. Bonding wire must be at least No. 8 AWG (8.4 mm²) solid copper wire. This is a most important safety assurance feature.

Before installing your spa, check with your local building department to ensure installation conforms to local building codes.

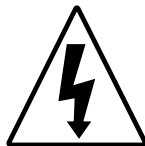

6.0 Electrical Installation Instructions (240V Service)

IMPORTANT NOTICE: The electrical wiring of this spa must meet the requirements of the National Electrical Code/USA (NEC) and any applicable state or local codes.

The electrical circuit must be installed by a qualified electrician and approved by a local building/electrical inspection authority.

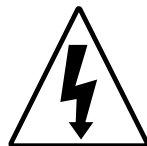

1. **DANGER: TO DECREASE THE RISK OF SHOCK, PRODUCT DAMAGE OR ELECTRICAL FIRE.**

This spa must be permanently connected (hard-wired) to the power supply. **No plug-in connections or extension cords are to be used in conjunction with the operation of this spa.** Supplying power to the spa which is not in accordance with these instructions will void both the independent testing agency listing and the manufacturer's warranty.

2. The power supplied to this spa must be a dedicated circuit with no other appliances or lights sharing the power provided by the circuit.

3. To determine the current, voltage and wire size required, refer to Section 7.0 "Power Requirements" (page 16) for your specific spa model.

- Wire size must be appropriate per NEC and/or local codes.
- We recommend type THHN wire.
- All wiring must be copper to ensure proper connections. **Do not use aluminum wire.**
- When using wire larger than #6 (10 mm²), add a junction box near the spa and reduce to short lengths of #6 (10 mm²) wire to connect to the spa.

4. The electrical supply for this product must include a suitably rated switch or circuit breaker to open all ungrounded supply conductors to comply with Section 422-20 of the National Electrical Code/USA, ANSI/NFPA 70. The disconnecting means must be readily accessible to the spa's occupant but installed at least 5 feet (1.5m) from spa water.
5. The electrical circuit supplied for the spa must include a suitable ground fault circuit interrupter (GFCI) as required by NEC Article 680-42/USA.
6. To gain access to the spa's power terminal block, remove the screws securing the cabinet panel on the side of the spa under the controls. Then remove the four door screws for the small access door on the control box (Figure A).
7. Select the power supply entrance you want to use (Figure A) and remove the short cabinet panel from the front of the spa. Make sure to install a 3/4" electrical fitting and conduit through the large opening provided in the bottom of the control box so you can feed the cable through to the terminal block.
8. Connect wires to the terminal block (Figures B-F, pages 13-15). **ALL WIRES MUST BE SECURELY CONNECTED** or equipment damage could result!
9. Install control access box door and reinstall the cabinet side panels.

Figure A
Equipment Area

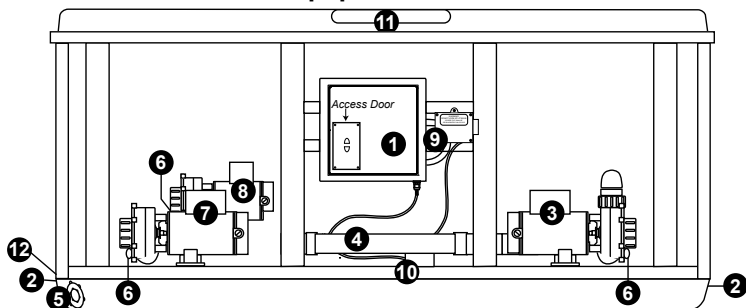

Note: Equipment location (such as pumps, CLEARRAY system, drain, heater etc.) varies by model.

- | | |
|-----------------------------|----------------------------------------------|
| 1. J-1000™ Control Box | 7. Jets Pump |
| 2. Power Supply Entrance(s) | 8. Filter/Circulation Pump |
| 3. Jets Pump | 9. CLEARRAY Water Purification System |
| 4. Heater | 10. Electronic Ballast (For CLEARRAY System) |
| 5. Spa Drain Valve | 11. J-1000 Control Panel |
| 6. Pump Drain Plugs(s) | 12. QuickDrain™ |

Figure B
60 Hz Terminal Block Connection

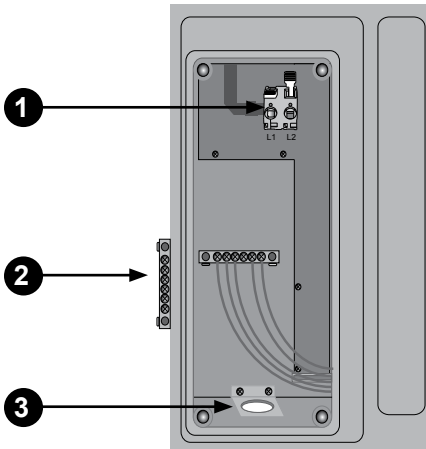

1. Main Terminal Block
2. Bonding Lug/Grounding Terminal
3. Power wires Entrance (Electrical fitting and conduit must be installed)

Figure C
Terminal Connection
(North American 240 VAC Connection Shown)

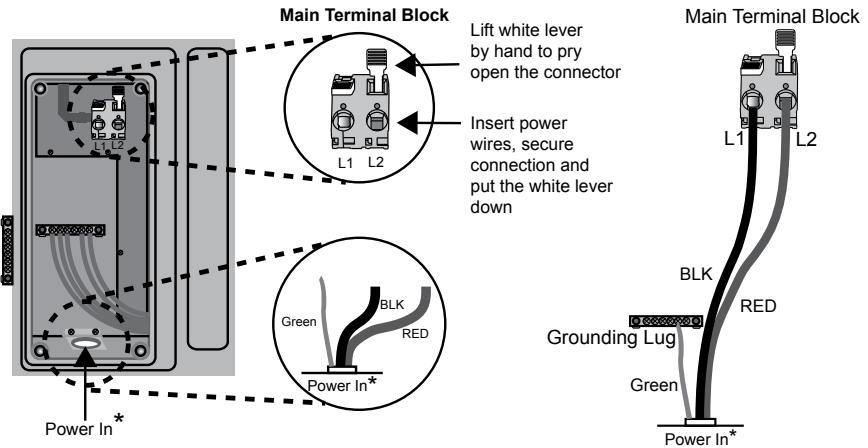

*Electrical fitting and conduit must be installed

Figure D
50Hz Terminal Block Connection

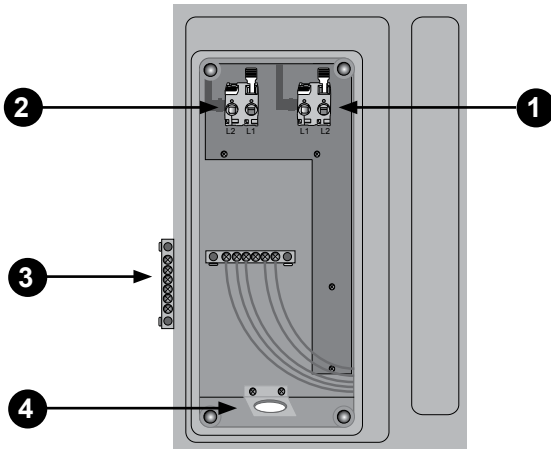

1. Main Terminal Block
2. Heater Terminal Block
3. Bonding Lug/Grounding Terminal
4. Power wires Entrance (Electrical fitting and conduit must be installed)

Figure E
Terminal Connection
(Export 230 VAC 50 Hz Connection Shown)

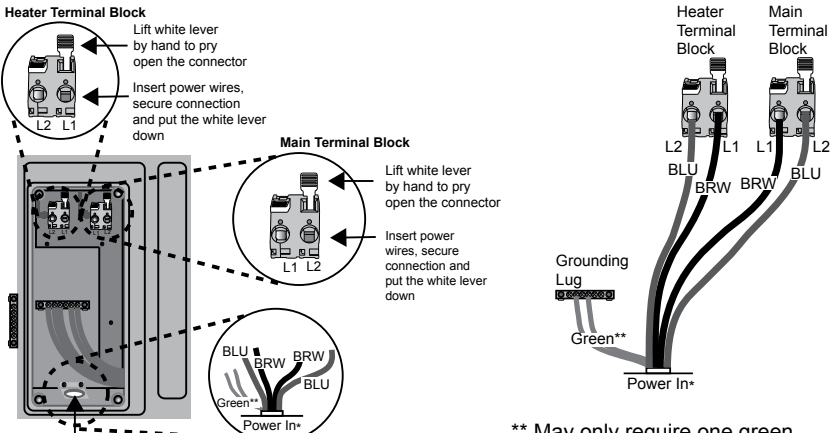

** May only require one green grounding wire. Check your local country codes.

*Electrical fitting and conduit must be installed

Figure F

1. Remove the access door on the controller.
2. Locate the gray Terminal, towards the top of the controller, Figure 1.

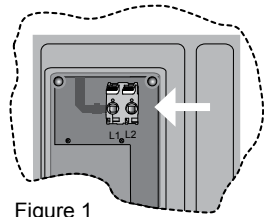

Figure 1

3. Grab one of the white levers. Push the lever upward to the open position, Figure 2. If opened correctly the lever will stay in place and remain open.

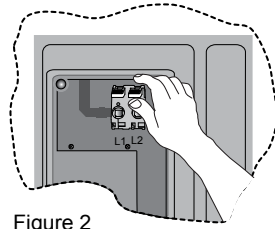

Figure 2

4. You will notice that lifting the lever opens the slot for the power wire, Figure 3. Insert the power wire into slot A as shown, Figure 4. Then put down the white lever and secure wire in place. Gently pull on wire after installation to verify it is clamped tightly into terminal.

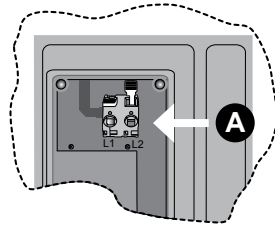

Figure 3

Side View

Front View

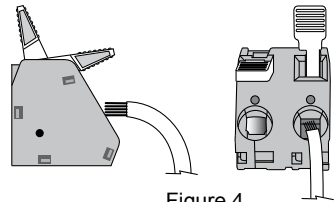
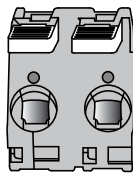
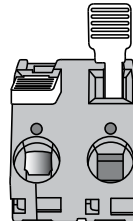

Figure 4

Closed tabs on
terminal blockOne closed and
one open tab on
terminal block

7.0 Power Requirements

Jacuzzi® spas are designed to provide optimum performance and flexibility of use when connected to their maximum electrical service. They are configured at the factory. The most common electrical connections are listed below:

- **All North American 60 Hz Models only:** These models come set for 50A logic. If you prefer, your qualified technician can perform a logic modification that allows the spas to operate on a different electrical service (see table footnotes below).

North American J-425/J-465/J-470/J-480 Models (60 Hz)

Voltage:	240 VAC	240 VAC	240 VAC
Max. Current Draw:	23A	36A	45A
Frequency:	60 Hz	60 Hz	60 Hz
Number of Wires:	3	3	3
Circuit Breaker (2-Pole):	30A*	50A**	60A***

* In 30A configuration, the heater **will not operate** while either jets pump is running.

** In 50A configuration, the heater **will operate** when one jets pump is running, but **will not operate** while both jets pumps are running. ***This is the factory setting.***

*** In 60A configuration the heater **will operate** while both jets pumps are running.

North American J-495 Models (60 Hz)

Voltage:	240 VAC	240 VAC	240 VAC
Max. Current Draw:	23A	36A	45A
Frequency:	60 Hz	60 Hz	60 Hz
Number of Wires:	3	3	3
Circuit Breaker (2-Pole):	40A*	50A**	60A***

* In 40A configuration, the heater **will not operate** when any jets pump is running.

** In 50A configuration, the heater **will operate** when one jets pump is running, but **will not operate** when two or more jets pumps are running. ***This is the factory setting.***

*** In 60A configuration the heater **will operate** when two jets pump are running, but **will not operate** when all three jets pumps are running.

North American J-415 Models (60 Hz)

Voltage:	240 VAC	240 VAC
Max. Current Draw:	25A	36A
Frequency:	60 Hz	60 Hz
Number of Wires:	3	3
Circuit Breaker (2-Pole):	30A*	50A**

- * In 30A configuration, the heater **will not operate** while the jets pump is running.
- ** In 50A configuration, the heater **will operate** while the jets pump is running. ***This is the factory setting.***

- **All Export 50 Hz Models:** These models have two terminals requiring 2 circuit breakers and only have one logic option available. The breaker size for the J-495 differs from all other J400 Models.

Export J-415/J-425/J-465/J-470/J-480 Models (50 Hz)

	Main Terminal Breaker*	Heater Terminal Breaker**
Voltage:	230 VAC	230 VAC
Max. Current Draw:	16.6A	12A
Wattage	3.8 kW	2.6 kW
Frequency:	50 Hz	50 Hz
Number of Wires:	3	3

- * The main terminal breaker is solely for the pumps, circulation pump, CLEARRAY, stereo option (if installed) and accessories.
- ** The heater breaker is solely for the heater, **to allow the heater to operate** while both jet pumps are running.

Note: Two breakers needed see Figure E page 14.

Export J-495 Models (50 Hz)

	Main Terminal Breaker*	Heater Terminal Breaker**
Voltage:	230 VAC	230 VAC
Max. Current Draw:	26.1A	12A
Wattage	6.0 kW	2.6 kW
Frequency:	50 Hz	50 Hz
Number of Wires:	3	3

- * The main terminal breaker is solely for the pumps, circulation pump, CLEARRAY, stereo option (if installed) and accessories.
- ** The heater breaker is solely for the heater, **to allow the heater to operate** while two jet pumps are running.

Note: Two breakers needed see Figure E page 14.

8.0 Spa Fill Up Procedure

For best results, read each step in its entirety before proceeding with this procedure.

1. Prepare The Spa For Filling

- Clear all debris from the spa. (Although the spa shell has been polished at the factory, you may want to treat it with a specially formulated spa cleaner.) Consult your authorized Jacuzzi dealer for additional information prior to filling spa.
- Remove both ProClarity™ and ProClear™ Plus skimmer, polishing filter lids and filters as illustrated in Section 15.1 (page 74).

2. Fill Spa

- Place the end of your garden hose into empty skimming filter bucket (filter bucket on your left) as you stand next to the spa. Fill spa half way, then place the garden hose into the opposite filter bucket (filter bucket on your right) while adding the remaining fill water.

CAUTION: TO DECREASE BUILD UP ON COMPONENTS AND MINIMIZE ACRYLIC DAMAGE.

Never fill with water from a water softener. If your water is extremely “hard,” it is preferable to fill half-way with hard water and the rest of the way with softened water. Water that is too soft can be corrosive to metal components.

-  **WARNING: TO DECREASE RISK OF INFECTION OR DISEASE.**

Fill hot tub with clean tap water from garden hose, to reduce risk of contracting a waterborne illness (e.g. an infection, bacteria or virus) and/or respiratory ailments. Fill until water covers all jets but does not touch the bottom of the lowest headrest (DO NOT OVERFILL!).

IMPORTANT: Always fill your spa through both filter buckets after draining. Failure to do so may cause air to be trapped in either pump, preventing the pump from circulating water. Remove the hose and replace both filter cartridges as illustrated in Section 15.1 (page 74).

3. Turn On Power

Turn on power to spa at the home's circuit breaker. The heater and filter/circulation pump will automatically activate. If the LCD display flashes the temperature icon and either “Water is below set-temp” or “Freeze protection” error, this is normal. Refer to page 88 for additional information.



4. Activate Jets Pumps

Turn on jet(s) pumps when adding chemicals in step 5 (see Section 11.2, page 56 to activate jets).



5. Add Start-Up Chemicals

Add the spa water chemicals as recommended by your authorized Jacuzzi spa dealer. See Section titled “Water Quality Maintenance” (page 82) for general guidance.



WARNING: RISK OF POISONING OR DEATH.

Never leave chemicals opened and accessible to anyone. Use chemicals according to the vendors instructions. Always store chemicals in a safe and/or locked location. Keep away from and out of reach of children.

6. Establish A Stable Sanitizer Reading

Establish a stable sanitizer reading of no less than 1.0 ppm free chlorine or 2.0 ppm bromine. To ensure healthy water conditions, always maintain a constant sanitizer reading within the levels recommended on the inside cover of this manual. If sanitizer levels cannot be stabilized, perform the decontamination procedure steps 1-7 on the following page.

Note: The “Decontamination Procedure” should also be used after the spa has been “Winterized” (Sec. 15.8, page 81) or has been sitting without power for an extended period.

7. Set Spa To Heat

To warm spa water to a comfortable temperature, follow these steps:

- The LCD display on the control panel displays the actual temperature of the spa water. Press either the **UP** or **DOWN** button on the Navigational Quad Keypad to increase or decrease the water temperature by 1 degree.
- The heater will turn off 1 degree above set temperature and turn on 1 degree below set temperature.

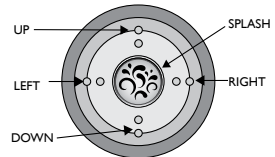

Important Heater Details:

- The maximum temperature for which the spa can be set is 104°F (40°C) and the minimum is 80°F (27°C).
- For North American spas: With a 50 amp service, turn off one of the jet pumps to operate heater. With a 30 amp service, turn off both jet pumps to operate heater. With a 60 amp service, the heater will operate with both jet pumps on.
- Setting the thermostat at maximum will not accelerate the heating process. This will only result in a higher ultimate temperature.
- The heater operates until the water reaches 1 degree above the programmed “set temperature,” then turns off. The heater will reactivate after the water cools to approximately 1 degree below the “set temperature.”

8. Place Cover On Spa

- Keeping the insulating cover in place anytime the spa is not in use will reduce the time required for heating, thereby minimizing operating costs.
- The time required for initial heat-up will vary depending on the starting water temperature.

**DANGER: RISK OF PERSONAL INJURY.**

Check water temperature carefully before entering hot tub! Excessive water temperature can cause burns, welts and body temperature to rise, hyperthermia (over-heating).

Decontamination Procedure

Steps 1-7 below are only required when sanitizer levels are unstable after performing Spa Fill Up Procedures steps 1-6. Disregard steps 1-7 below if sanitizer levels remain stable after performing steps 1-6 above (refer to the inside cover of the manual).

1. Add 2.5 ounces of sodium dichlor for every 100 gallons of water. Refer to the table below for approximate water fill volume by model.

**CAUTION: RISK OF PERSONAL INJURY OR SPA DAMAGE!**

Never add chlorine tablets (trichlor) or acid to your hot tub for any reason! These chemicals may damage components within your hot tub, burn or irritate your skin, create a rash, and void the manufacturer warranty for your spa.

Water Fill Volume by Model

Model	Average Fill Volume*	Sodium Dichlor
J-415.....	230 Gal (765 L).....	6.0 oz
J-425.....	340 Gal (1,287 L).....	9.0 oz
J-465.....	410 Gal (1,552 L).....	10.25 oz
J-470.....	450 Gal (1,703 L).....	11.0 oz
J-480.....	480 Gal (1,817 L).....	12.0 oz
J-495.....	560 Gal (2,120 L).....	14.0 oz

*Use average fill volume for chemical maintenance

2. Leave spa cover open during this step to allow excessive chemical vapors to exit spa, protecting pillows and plastic knobs from chemical attack. If spa is indoors, open doors and windows for proper ventilation. Turn on all spa jet pumps for one hour, open all air controls, and place all massage selector knob(s) in their center "combo" position as shown.

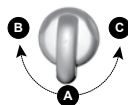

Note: You will need to activate the jet pumps every 20 minutes since these functions have an automatic 20 minute time-out that turns them off.



WARNING: RISK OF PERSONAL INJURY!

- To decrease the risk of injury, drowning or entrapment, never leave your hot tub unattended for any reason while the cover is open and accessible, especially to small children and animals!
- Precautions should be taken to minimize your exposure to chemical vapors (that could cause lung, brain, or skin damage).

3. Turn off power to the spa at the circuit breaker, then drain tub as outlined in Section 15.2 (page 78).
4. Refill spa with clean tap water from garden hose until water covers all jets but does not touch the bottom of the lowest headrest with all headrests in their lowest position (DO NOT OVERFILL!)

CAUTION: TO DECREASE BUILD UP ON COMPONENTS AND MINIMIZE ACRYLIC DAMAGE.

Never fill with water from a water softener. If your water is extremely "hard," it is preferable to fill half-way with hard water and the rest of the way with softened water. Water that is too soft can be corrosive to metal components.

5. Consult your authorized Jacuzzi dealer for chemical recommendations, then add chemicals to hot tub water to achieve a constant sanitizer reading within the levels recommended on the inside cover of this manual.
6. Turn on jet pumps when adding chemicals to ensure proper mixing and leave your hot tub cover open until the sanitizer level becomes stable to protect pillows and plastic knobs from chemical attack. Refer to the inside cover of the manual.

**WARNING: RISK OF PERSONAL INJURY.**

- To decrease the risk of injury, entrapment or drowning, never leave your hot tub unattended for any reason while the cover is open and accessible to small children and animals!
- To decrease the possibility of contracting a waterborne illness (e.g. an infection, bacteria or virus) and/or respiratory ailments, maintain water chemistry within step 6 parameters. If you or other bathers experience such a condition, discontinue use and seek medical attention.

7. Establish a sanitizer reading no less than 1.0 ppm free chlorine or 2.0 ppm bromine, then allow the hot tub to set undisturbed for 8 hours. Retest water after 8 hours to determine if sanitizer levels are stable. If sanitizer levels are stable, your spa is ready for use. To ensure healthy water conditions, always maintain a constant sanitizer reading within the levels recommended on the inside cover of this manual. If sanitizer levels are not stable at this time, it will be necessary to repeat this procedure in its entirety until stable sanitizer readings are achieved.

IMPORTANT: If the CLEARRAY® water purification system is removed from the hot tub or is not operating effectively follow the “without CLEARRAY®” water chemistry parameters as defined by the Association of Pool and Spa Professionals.

8. After adequate sanitizer levels are achieved, close all spa air controls to maximize heat retention when spa is not in use.

9.0 Spa Features

9.1 J-495 Spa Features

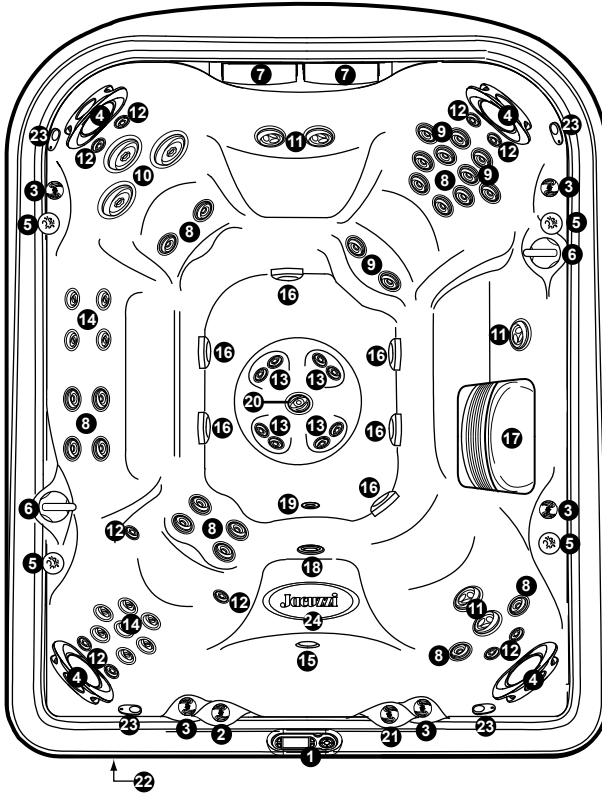

- | | |
|---------------------------------------------------------------------|--------------------------------------------------------|
| 1. J-1000™ Control Panel | 12. NX2 Jets (10 ea.) |
| 2. Lighted IX Jet Flow Control Valve | 13. FX-M Jets (8 ea.) |
| 3. Air Control Valves (5 ea.) Introduce Air to Specified Jet Groups | 14. RX3 Jets (11 ea.) |
| 4. Adjustable Pillows (4 ea.) | 15. Underwater Light |
| 5. Lighted Cup Holders (4 ea.) | 16. Footwell Filter Suction Covers (6 ea.) |
| 6. Massage Selectors (2 ea.) Controls Specified Jet Groups | 17. Filter/Skimmer Grill |
| 7. Waterfalls (2 ea.) | 18. Waterfall Filtration Return |
| 8. FX Jets (18 ea.) | 19. Gravity Drain/Heater Input/CLEARRAY Return Fitting |
| 9. FX-S Jets (6 ea.) | 20. Lighted IX Jet |
| 10. MX2 Jets (3 ea.) | 21. Waterfall Control Valve |
| 11. FX2-S Jets (5 ea.) | 22. Optional J-1000 Audio System |
| | 23. Optional Audio System Speakers (4 ea.) |
| | 24. Lighted Seat Logo |

Spa features subject to change without notice

9.2 J-495 Massage/Waterfall Selector Diagram

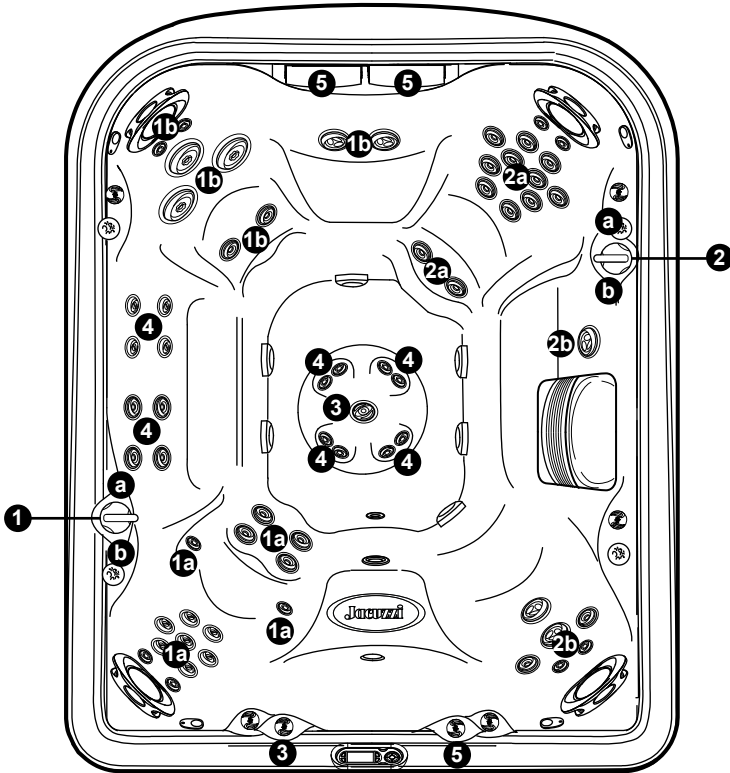

Massage Selector (1)

- Massage selector 1 diverts jets pump N° 2 output between jets groups 1a-1b.
- Massage selector 2 diverts jets pump N° 1 output between jets groups 2a-2b.

IX Jet Flow Control Valve (3)

- Valve (3) controls output to footwell IX Jet when jets pump N° 3 is running.

Jets Without Massage Selector Controls (4)

- Jets (4) are always on when jets pump N° 3 is running.

Waterfall Selector (5)

- Waterfall selector (5) controls circulation pump output to waterfall.

9.3 J-495 Air Controls Diagram

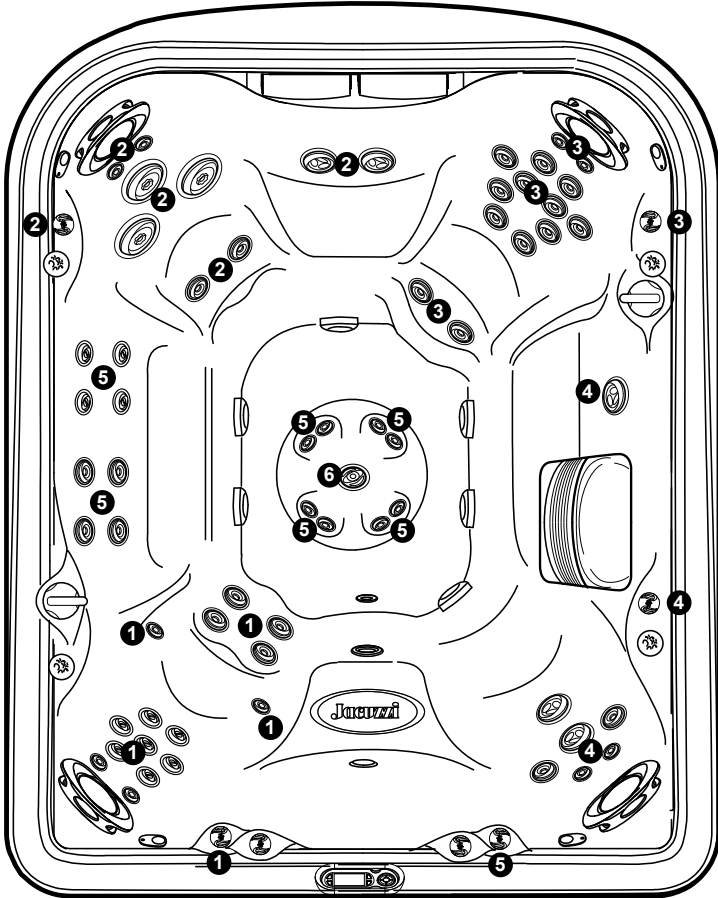

Air Controls Operation

- Rotate air controls 1-5 to add air to designated jet groups.
- Center footwell IX Jet (6) draws air at all times when jets pump N° 3 is running. This jet has no air control.

9.4 J-480 Spa Features

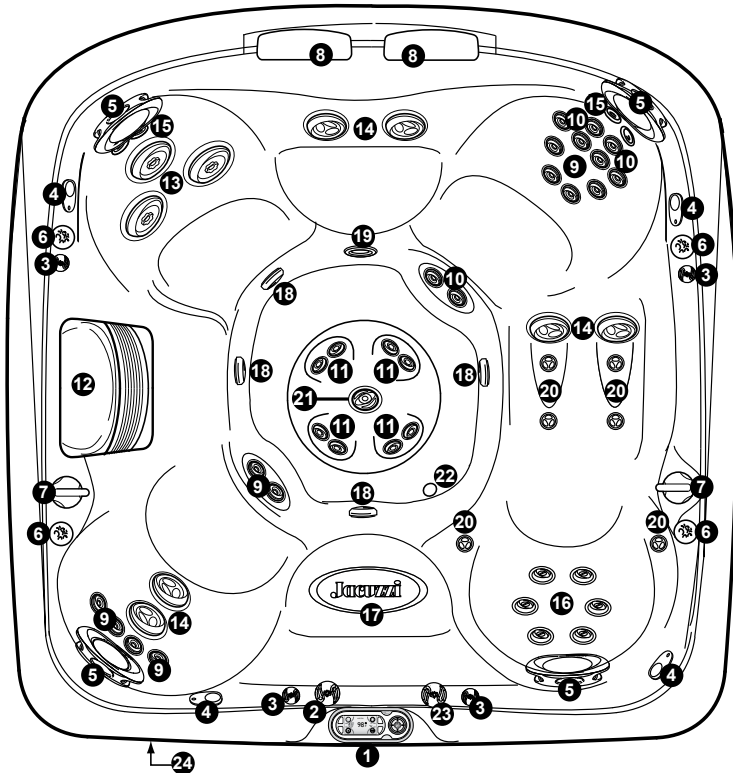

- | | |
|---------------------------------------------------------------------|----------------------------------------------------------|
| 1. J-1000™ Control Panel | 14. FX2-S Jets (6 ea.) |
| 2. Waterfall Control Valve | 15. NX2 Jets (4 ea.) |
| 3. Air Control Valves (4 ea.) Introduce Air to Specified Jet Groups | 16. RX3 Jets (6 ea.) |
| 4. Optional Audio System Speakers (4 ea.) | 17. Lighted Seat Logo |
| 5. Adjustable Pillows (4 ea.) | 18. Footwell Filter Suction Covers (4 ea.) |
| 6. Lighted Cup Holders (4 ea.) | 19. Waterfall Filtration Return |
| 7. Massage Selectors (2 ea.) Controls Specified Jet Groups | 20. PX Calf Jets (6 ea.) |
| 8. Waterfalls (2 ea.) | 21. Lighted IX Jet |
| 9. FX Jets (12 ea.) | 22. Gravity Drain/Heater Input/CLEARARRAY Return Fitting |
| 10. FX-S Jets (6 ea.) | 23. Lighted IX Jet Flow Control Valve |
| 11. FX-M Jets (8 ea.) | 24. Optional J-1000 Audio System |
| 12. Filter/Skimmer Grill | |
| 13. MX2 Jets (3 ea.) | |

Spa features subject to change without notice

9.5 J-480 Massage/Waterfall Selector Diagram

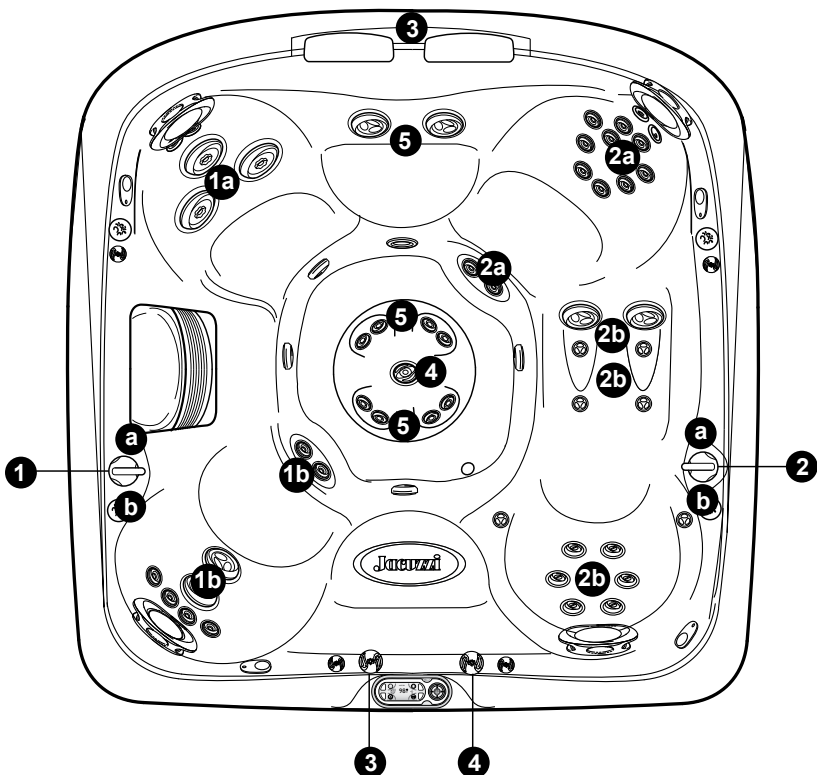

Massage Selectors (1-2)

- Massage selector 1 diverts jets pump N° 1 output between jet groups 1a-1b.
- Massage selector 2 diverts output jets pump N° 2 between jet groups 2a-2b.

Waterfall Selector (3)

- Waterfall selector 3 controls circulation pump output to waterfalls.

IX Jet Flow Control Valve (4)

- Valve (4) controls output to footwell IX Jet when jets pump N° 2 is running.

Jets Without Massage Selector Controls (5)

- Jets (5) are always on when jets pump N° 1 is running.

9.6 J-480 Air Controls Diagram

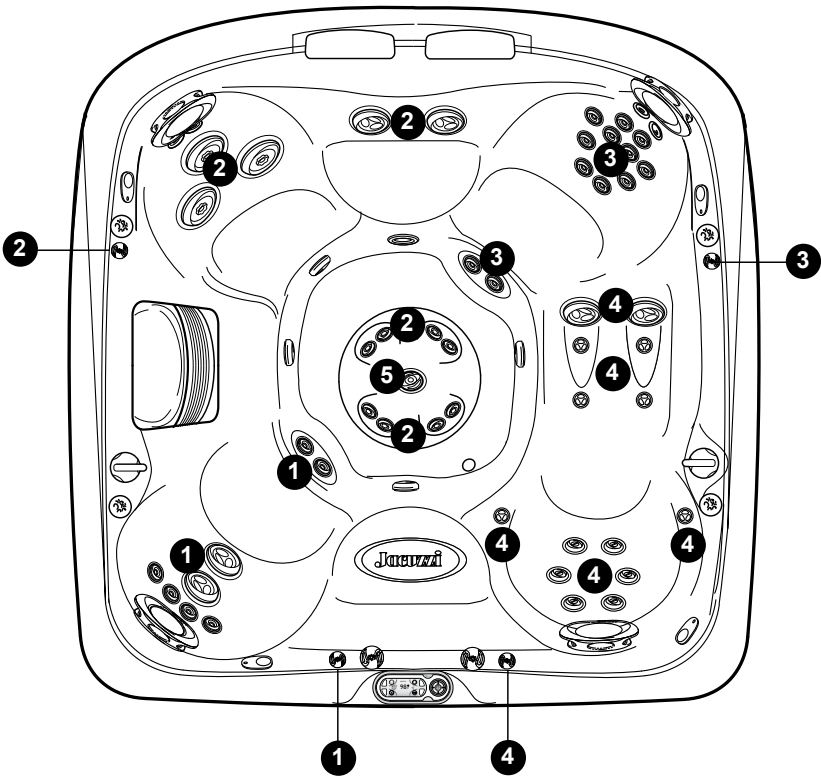
**Air Controls Operation**

- Rotate air controls 1-4 to add air to designated jet groups.
- Center footwell IX Jet (5) draws air at all times when jets pump is running. This jet has no air control.

9.7 J-470 Spa Features

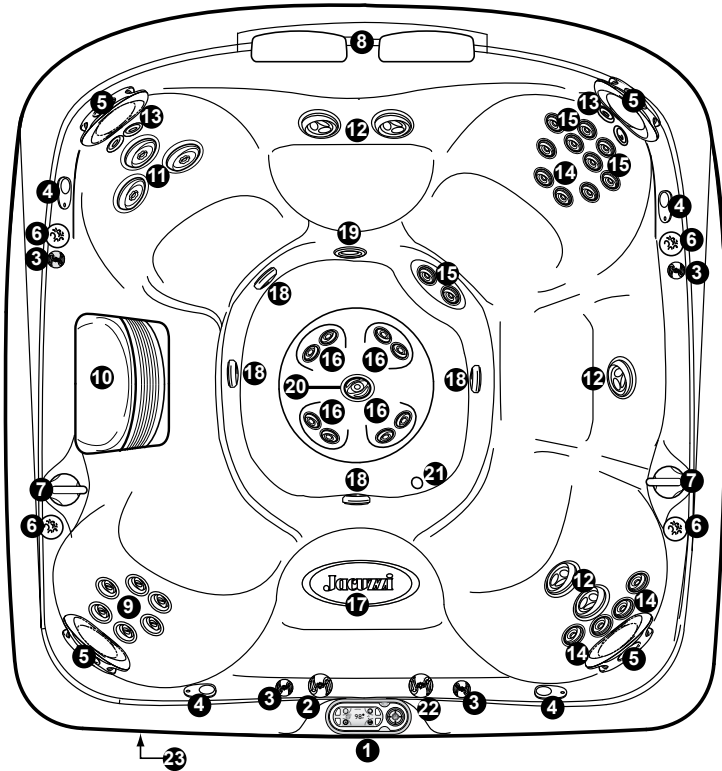

- | | |
|---------------------------------------------------------------------|----------------------------------------------------------|
| 1. J-1000 Control Panel | 12. FX2-S Jets (5 ea.) |
| 2. Waterfall Control Valve | 13. NX2 Jets (4 ea.) |
| 3. Air Control Valves (4 ea.) Introduce Air to Specified Jet Groups | 14. FX Jets (10 ea.) |
| 4. Optional Audio System Speakers (4 ea.) | 15. FX-S Jets (6 ea.) |
| 5. Adjustable Pillows (4 ea.) | 16. FX-M Jets (8 ea.) |
| 6. Lighted Cup Holders (4 ea.) | 17. Lighted Seat Logo |
| 7. Massage Selectors (2 ea.) Controls Specified Jet Groups | 18. Footwell Filter Suction Covers (4 ea.) |
| 8. Waterfalls (2 ea.) | 19. Waterfall Filtration Return |
| 9. RX3 Jets (6 ea.) | 20. Lighted IX Jet |
| 10. Filter/Skimmer Grill | 21. Gravity Drain/Heater Input/CLEARARRAY Return Fitting |
| 11. MX2 Jets (3 ea.) | 22. Lighted IX Jet Flow Control Valve |
| | 23. Optional J-1000 Audio System |

Spa features subject to change without notice

9.8 J-470 Massage/Waterfall Selector Diagram

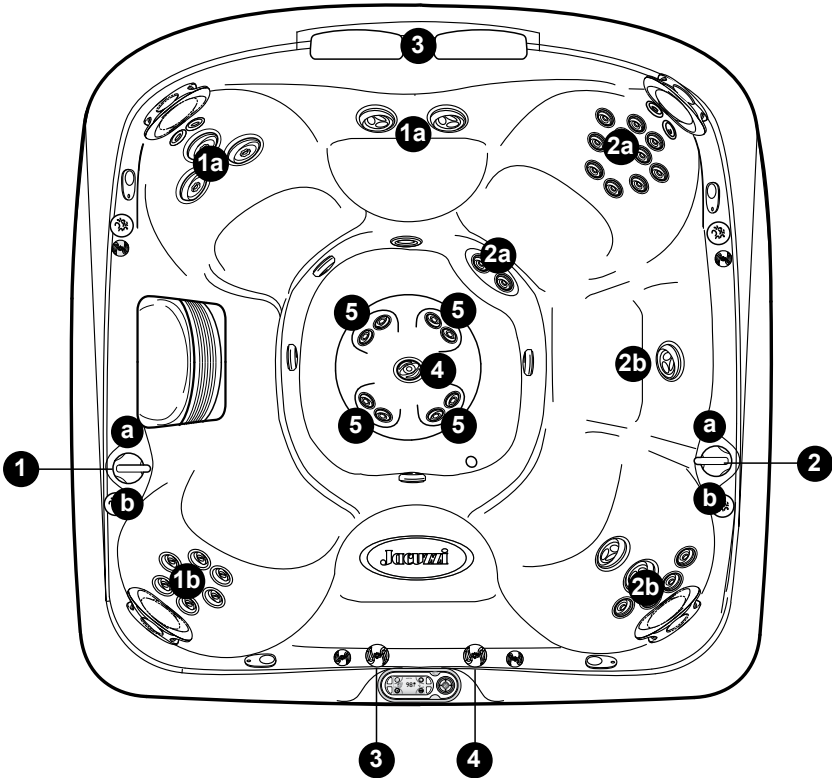
**Massage Selectors (1-2)**

- Massage selector 1 diverts jets pump N° 1 output between jet groups 1a-1b.
- Massage selector 2 diverts jets pump N° 2 output between jet groups 2a-2b.

Waterfall Selector (3)

- Waterfall selector 3 controls circulation pump output to waterfalls.

IX Jet Flow Control Valve (4)

- Valve (4) controls output to footwell IX Jet when jets pump N° 2 is running.

Jets Without Massage Selector Controls (5)

- Jets (5) are always on when jets pump N° 1 is running.

9.9 J-470 Air Controls Diagram

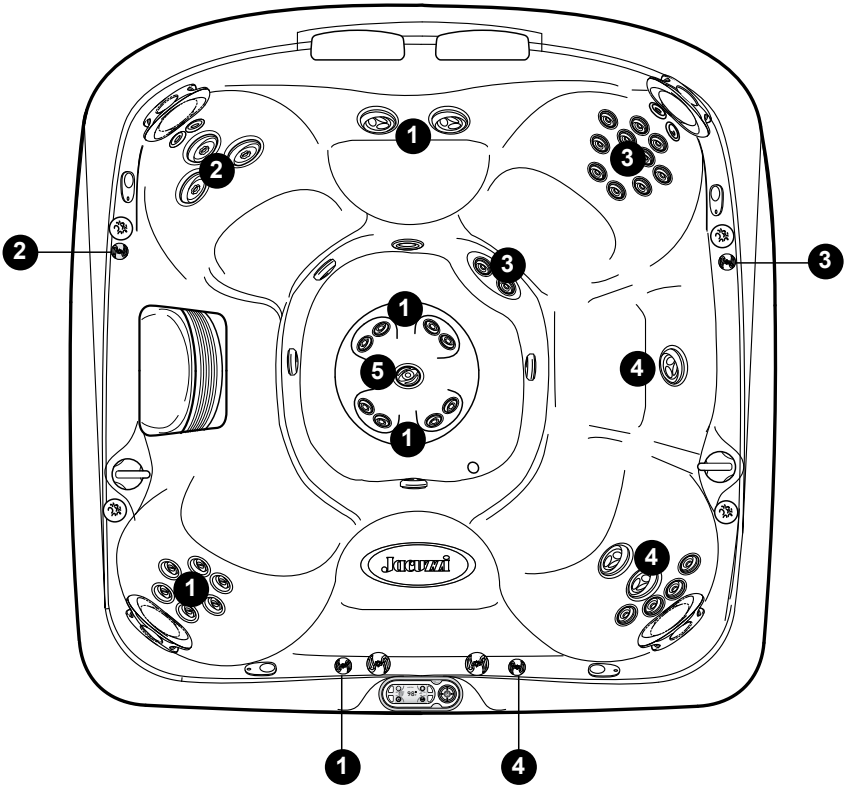

Air Controls Operation

- Rotate air controls 1-4 to add air to designated jet groups.
- Center footwell IX Jet (5) draws air at all times when jets pump is running. This jet has no air control.

9.10 J-465 Spa Features

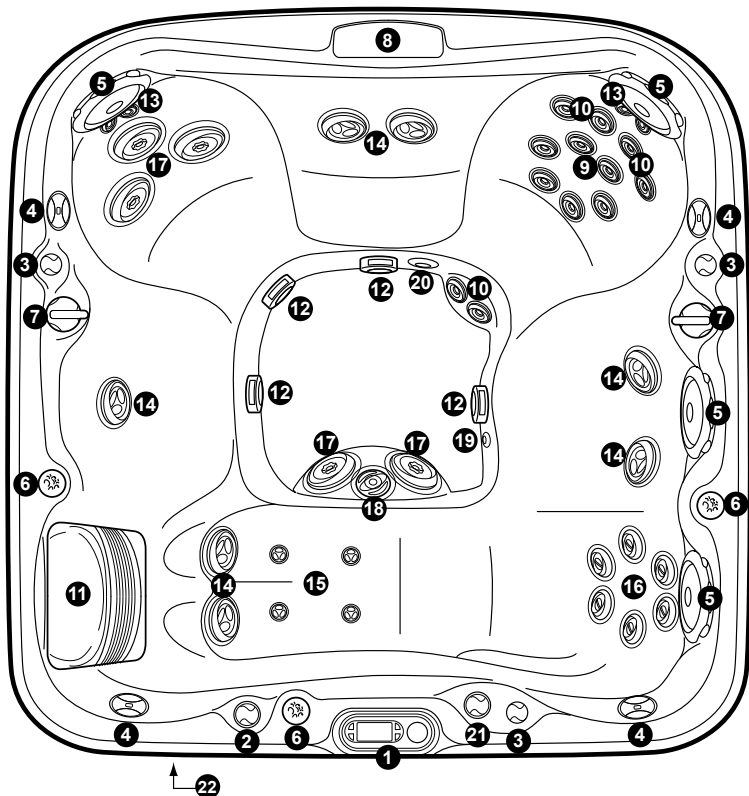

- | | |
|---------------------------------------------------------------------|--------------------------------------------------------|
| 1. J-1000 Control Panel | 13. NX2 Jets (4 ea.) |
| 2. Waterfall Control Valve | 14. FX2-S Jets (7 ea.) |
| 3. Air Control Valves (3 ea.) Introduce Air to Specified Jet Groups | 15. PX Jets (4 ea.) |
| 4. Optional Audio System Speakers (4 ea.) | 16. RX3 Jets (6 ea.) |
| 5. Adjustable Pillows (4 ea.) | 17. MX2 Jets (5 ea.) |
| 6. Lighted Cup Holders (3 ea.) | 18. Lighted IX Jet |
| 7. Massage Selectors (2 ea.) Controls Specified Jet Groups | 19. Gravity Drain/Heater Input/CLEARRAY Return Fitting |
| 8. Waterfall | 20. Waterfall Filtration Return |
| 9. FX Jets (6 ea.) | 21. Lighted IX Jet Flow Control Valve |
| 10. FX-S Jets (6 ea.) | 22. Optional J-1000 Audio System |
| 11. Filter/Skimmer Grill | |
| 12. Footwell Filter Suction Covers (4 ea.) | |

Spa features subject to change without notice

9.11 J-465 Massage/Waterfall Selector Diagram

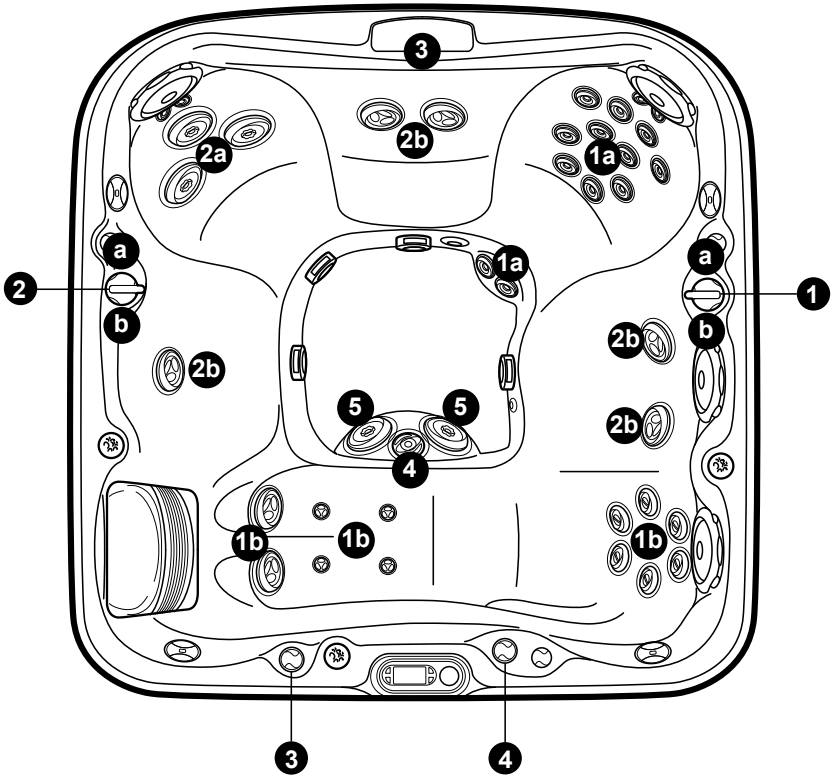

Massage Selectors (1-2)

- Massage selector 1 diverts jets pump N° 1 output between jet groups 1a-1b.
- Massage selector 2 diverts jets pump N° 2 output between jet groups 2a-2b.

Waterfall Selector (3)

- Waterfall selector 3 controls circulation pump output to waterfalls.

IX Jet Flow Control Valve (4)

- Valve (4) controls output to footwell IX Jet when jets pump N° 1 is running.

Jets Without Massage Selector Controls (5)

- Jets (5) are always on when jets pump N° 2 is running.

9.12 J-465 Air Controls Diagram

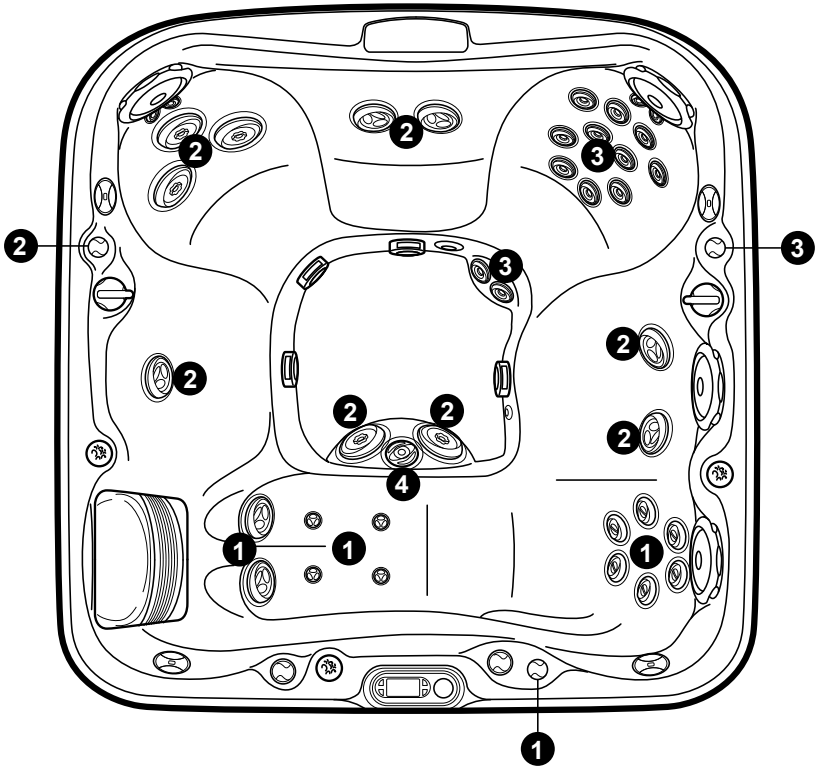

Air Controls Operation

- Rotate air controls 1-3 to add air to designated jet groups.
- Center footwell IX Jet (4) draws air at all times when jets pump is running. This jet has no air control.

9.13 J-425 Spa Features

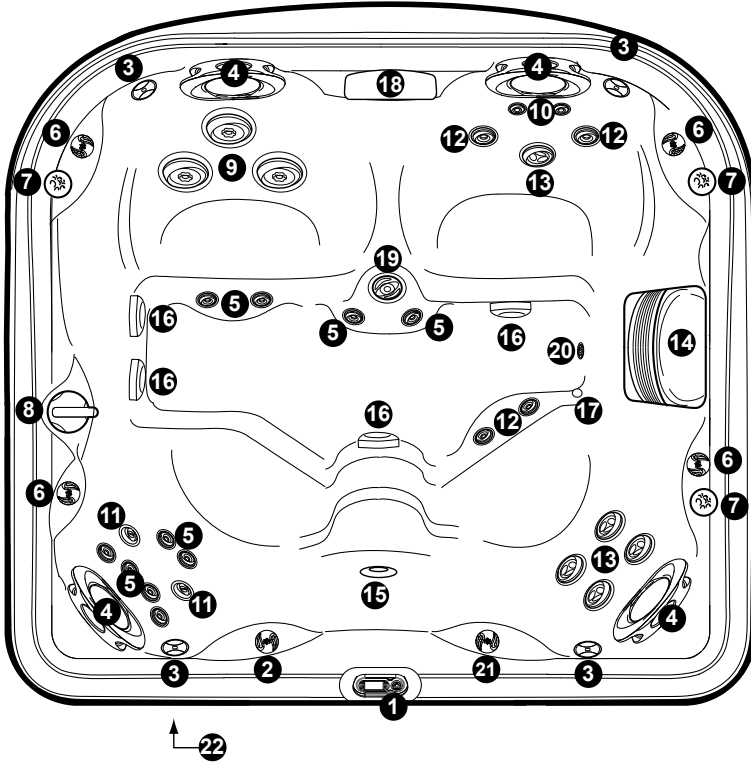

- | | |
|------------------------------------------------------------------------|-------------------------------------------------------------|
| 1. J-1000 Control Panel | 12. FX-S Jets (4 ea.) |
| 2. Waterfall Control Valve | 13. FX2-S Jets (5 ea.) |
| 3. Optional Audio System Speakers
(4 ea.) | 14. Filter/Skimmer Grill |
| 4. Adjustable Pillows (4 ea.) | 15. Underwater Light |
| 5. FX Jets (10 ea.) | 16. Footwell Filter Suction Covers (4 ea.) |
| 6. Air Control Valves (4 ea.) Introduce Air
to Specified Jet Groups | 17. Gravity Drain/Heater Input/CLEARARRAY
Return Fitting |
| 7. Lighted Cup Holders (3 ea.) | 18. Waterfall |
| 8. Massage Selector (1 ea.) Controls
Specified Jet Groups | 19. Lighted IX Jet |
| 9. MX2 Jets (3 ea.) | 20. Waterfall Filtration Return |
| 10. NX2 Jets (2 ea.) | 21. Lighted IX Jet Flow Control Valve |
| 11. RX3 Jets (2 ea.) | 22. Optional J-1000 Audio System |

Spa features subject to change without notice

9.14 J-425 Massage/Waterfall Selector Diagram

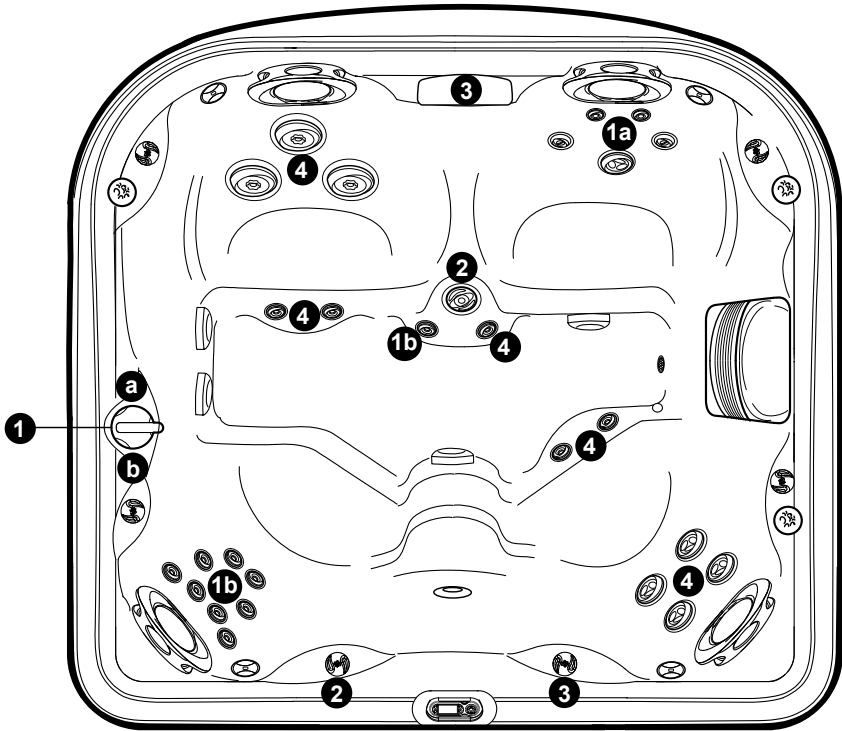
**Massage Selector (1)**

- Massage selector 1 diverts jets pump N° 1 output between jet groups 1a-1b.

IX Jet Flow Control Valve (2)

- Valve (2) controls output to footwell IX Jet when jets pump N° 1 is running.

Waterfall Selector (3)

- Waterfall selector (3) controls circulation pump output to waterfall.

Jets Without Massage Selector Controls (4)

- Jets (4) are always on when jets pump N° 2 is running.

9.15 J-425 Air Controls Diagram

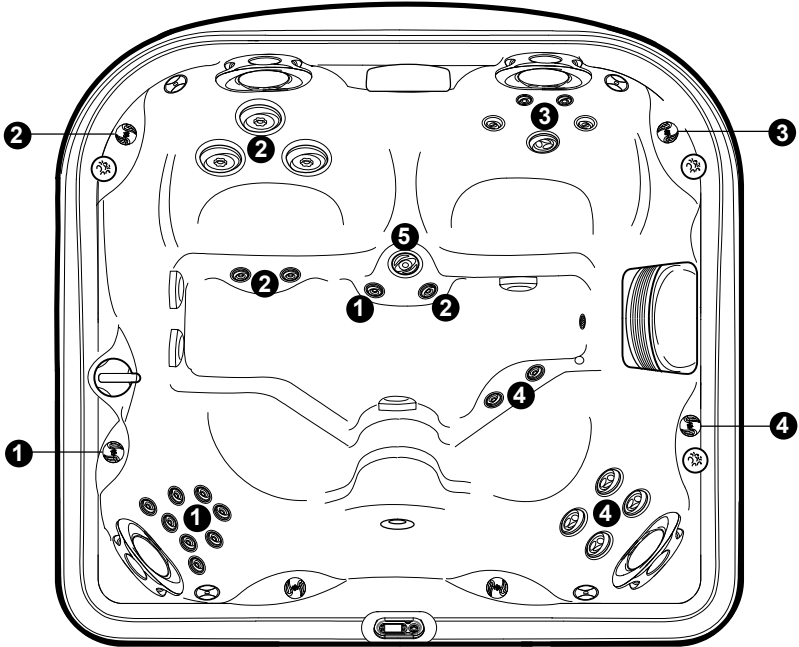

Air Controls Operation

- Rotate air controls 1-4 to add air to designated jet groups.
- Center footwell IX Jet (5) draws air at all times when jets pump is running. This jet has no air control.

9.16 J-415 Spa Features

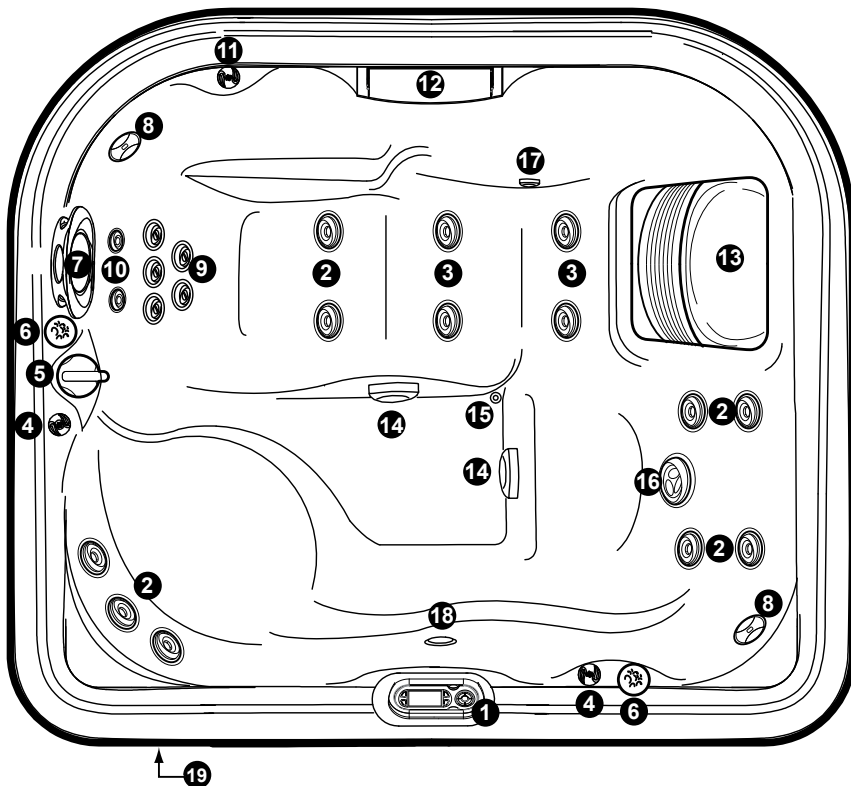

- | | |
|---------------------------------------------------------------------|--------------------------------------------------------|
| 1. J-1000 Control Panel | 11. Waterfall Control Valve |
| 2. FX Jets (9 ea.) | 12. Waterfall |
| 3. FX-S Jets (4 ea.) | 13. Filter/Skimmer Grill |
| 4. Air Control Valves (2 ea.) Introduce Air to Specified Jet Groups | 14. Footwell Filter Suction Covers (2 ea.) |
| 5. Massage Selector (1 ea.) Controls Specified Jet Groups | 15. Gravity Drain/Heater Input/CLEARRAY Return Fitting |
| 6. Integrated Cup Holders (2 ea.) | 16. FX2-S Jets (1 ea.) |
| 7. Adjustable Pillow | 17. Waterfall Overflow |
| 8. Optional Audio System Speakers (2 ea.) | 18. Underwater Light |
| 9. RX3 Jets (5 ea.) | 19. Optional J-1000 Audio System |
| 10. NX2 Jets (2 ea.) | |

Spa features subject to change without notice

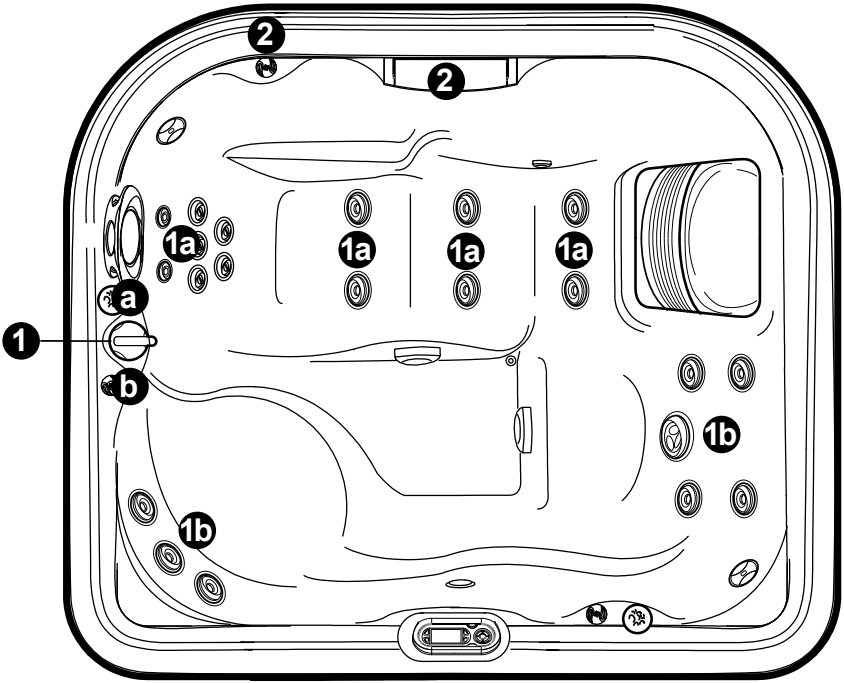
9.17 J-415 Massage/Waterfall Selector Diagram**Massage Selector (1)**

- *Massage selector 1 diverts output between jet groups 1a-1b.*

Waterfall Selector (2)

- *Waterfall selector 2 controls circulation pump output to waterfall.*

9.18 J-415 Air Controls Diagram

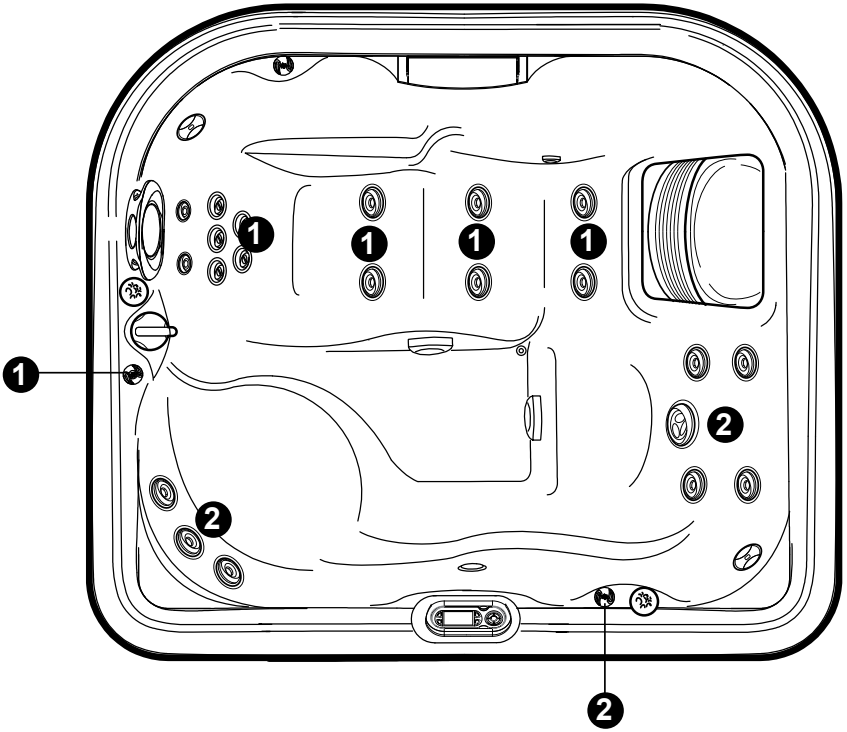

Air Controls Operation

- Rotate air controls 1-2 to add air to designated jet groups.

10.0 Control Panel Main Menu

10.1 Control Panel

Your Jacuzzi Spa is equipped with a state-of-the-art control panel. You will be able to access sets of multi-level menus. Familiarize yourself with the following information, so you can gain the full benefits of your spa. By learning the key features of the control panel, you will navigate through the menus and programming with ease. You will be referred back to this page as you move on to proceeding sections. Please pay close attention to the key points below.

- Although the graphics on the LCD display are vivid and colorful, the screen is not a touch-screen. The screen does display menu icons on every corner. These menus are activated by the button located just to the side of them (buttons A-D).
- At times you will see up, down, left or right arrows surrounding key features that are selected or made by using the Navigational Quad Keypad (see below).
- In the center of the Quad Keypad is the “Splash” button. This button is mostly used to save, set, reset or enter your changes.
- Located to the left, about mid-screen, is an icon that lets you know what menu you are currently in.

Note: The Start up menu will time out after approximately 3 seconds and then change to the display in Section 10.2, page 42. Display for the control panel will vary depending on the model.

START UP MENU DIAGRAM

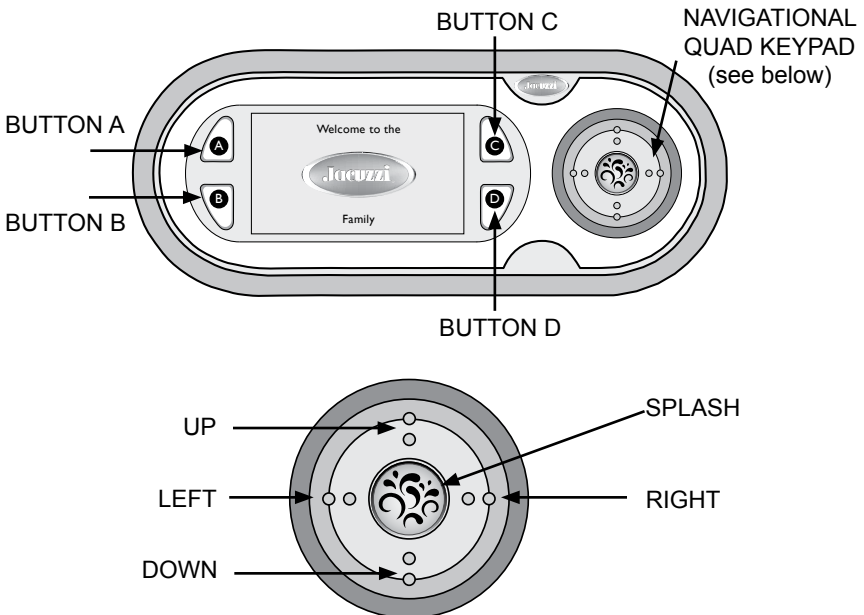

10.2 Main Menu Features

From the Main Menu you can access the main component menus to operate your Jacuzzi Spa. Listed below is a list of the Main Menu icons.

A. Menu Control Buttons



 **Temp.** = **Temperature Control:** Indicates that by using the Quad Keypad you can:

- Increase the temperature by pressing the Up button.
- Decrease the temperature by pressing the Down button.
- To display the temperature in °F, press the Right button.
- To display the temperature in °C, press the Left button.

Note: The temperature range for the spa is 80 to 104°F (27 to 40°C). To activate the **Extended Temperature feature**, that allows the spa to reach 106°F (41°C), refer to page 90.



= **Heating Icon:** Indicates that the heater is on and heating the water. **If icon is blinking**, refer to page 90.



= **Temperature Indicator:** The thermometer icon will either rise or fall depending on the actual water temperature.



below
79°F



80°-88°F



89°-98°F







99°-104°F



105°F
higher

- A** = **Button A:** Press this button to access the corresponding menu located to the right side of it.
- B** = **Button B:** Press this button to access the corresponding menu located to the right side of it.
- C** = **Button C:** Press this button to access the corresponding menu located to the left side of it.

-  = **Button D:** Press this button to access the corresponding menu located to the left side of it.
-  = **Entertainment Menu Icon:** Press button A to access the menu to operate the J-1000 Audio System (page 45).
-  = **Jets Menu Icon:** Press button B to access the menu to operate the jets pump (page 56).
-  = **Lights Menu Icon:** Press button C to access the menu to operate the lights and lighting effects (page 57).
-  = **Settings Menu Icon:** Press button D to access the menu to program and operate a majority of the key functions of the spa.

B. Menu Indicators

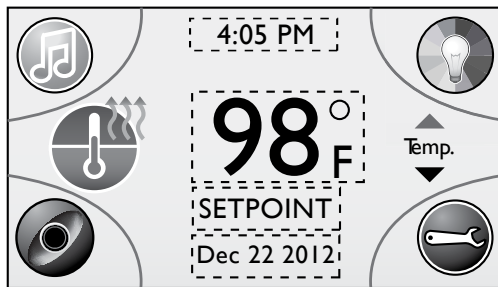

- 4:05 PM
1605 = **Time Indicator:** The time will always be shown when the Main Menu is displayed. The appearance will vary depending on whether the clock is set to a 12-Hour or 24-Hour configuration, Section 14.3, page 72.

Note: The spa does not adjust for daylight saving time, so the time must be manually adjusted. The AM or PM indicators will only appear with the 12-Hour configuration.

- 98[°]_F
37.6[°]_C = **Temperature:** Displays the actual water temperature in either °F or °C. Reference “Temperature Control” in Section 10.2, page 42.

SETPOINT = **Temperature Setpoint:** Displays the temperature that the spa has been set to. Press the Up or Down button on the Quad Keypad once to view setpoint. The word “setpoint” will only appear when manually setting the temperature.

- Dec 22 2012 = **Date:** The date will always be shown when the Main Menu is displayed, Section 14.2 page 71.

10.3 Menu Flowchart

The flowchart below is included to help you understand the spa's navigational screens. By pressing the buttons located next to each corner icon, you will enter additional menus and submenus. Each menu is covered in detail in the sections to follow.

Note: If your spa is not equipped with an audio system. The Entertainment Menu and menu icon () will not appear and be replaced with a Lock icon ().

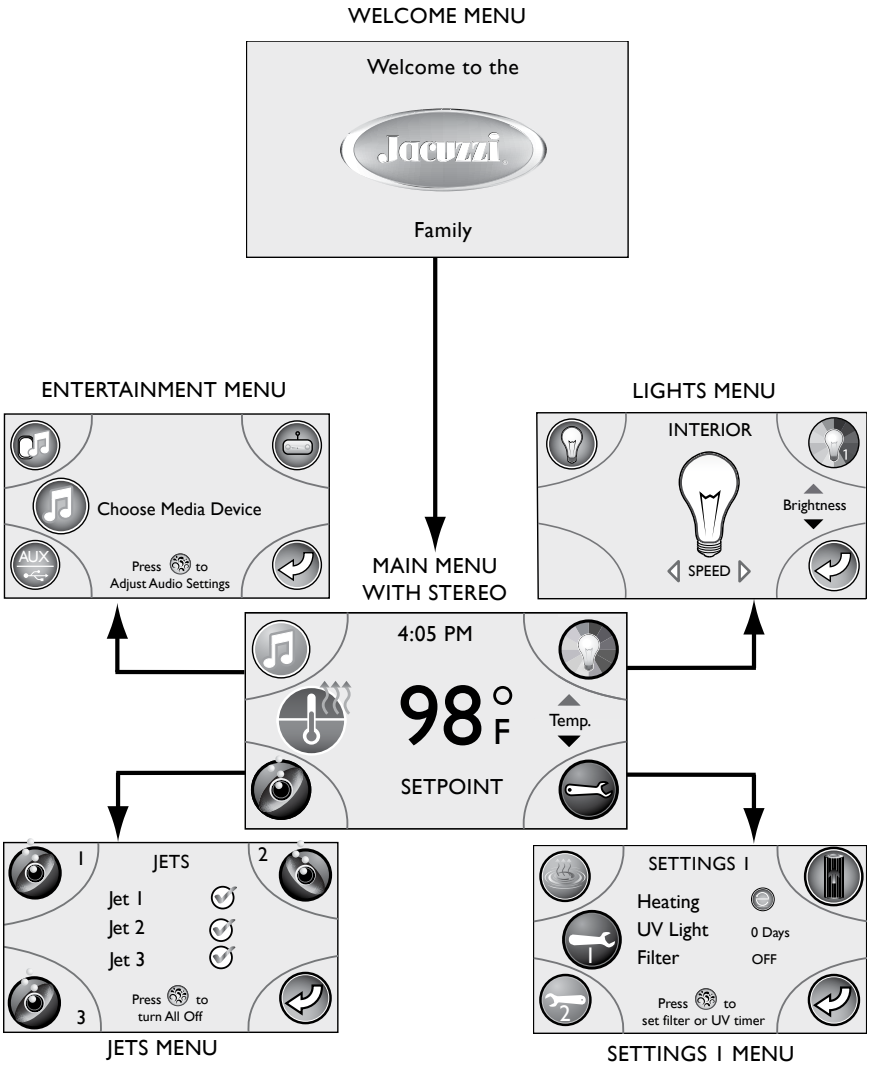

10.4 Entertainment Menu Display

Jacuzzi models equipped with the optional J-1000 Audio System offer an enhanced spa experience. These models include an integrated Bluetooth, FM Radio, iPod®, Universal Serial Bus, Auxiliary device receiver, four high fidelity spa engineered speakers for unsurpassed sound quality and long-life, and an integrated subwoofer for a superb acoustical sound. A wireless remote control can be used to further enhance your experience by providing full sound, lighting and jets control at your fingertips.

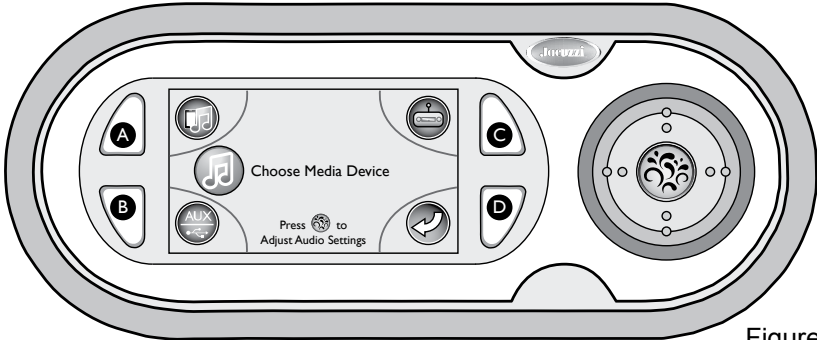

Figure A



= **Bluetooth Menu Icon:** In order for this feature to work a Bluetooth device must be connected. Press button A to access the Bluetooth submenu from this screen (page 46).

Note: Bluetooth menu icon will animate when a Bluetooth device is connect to the receiver.



= **Auxiliary (AUX)/Universal Serial Bus (USB) Menu Icon:** Press button B to access the AUX device submenu (page 47) from this screen.

Note: Will default to last device used.



= **Radio Menu Icon:** Press button C to access the FM tuner and FM preset modes (page 50).



= **Previous Icon:** Press button D to return to the Main Menu.



= **Splash Button:** This is a multi-task button, depending on the menus and action required. Pressing this button will take you to the Adjust Audio Settings Menu from this screen (page 53).

Note: Digital Rights Management (DRM) Files cannot be played on this deck. Personal files (MP3, WMA, iTunes or AAC) can be played as long as they are not DRM encrypted.

10.5 Bluetooth Submenu

While in the Entertainment menu (only when a Bluetooth device is connect) press button A to access the Bluetooth submenu (Figure B). You can scroll through the tracks, control the volume, and pause/play the device.

Note: In order to use your Bluetooth device it must be paired to the J1000 audio system. Please refer to the Bluetooth device operating manual for pairing instructions.



WARNING: RISK OF ELECTRICAL SHOCK HAZARD EXISTS AND EQUIPMENT DAMAGE! Never install or remove electrical devices while hands are wet or while sitting partially immersed or fully immersed in spa!

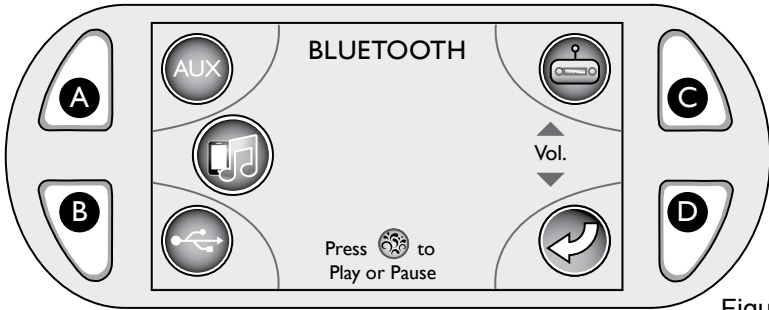

Figure B



= **Quad keypad:** Press the Left button to move to the previous track. Press the Right button to move to the next track.



= **Bluetooth Icon:** A Bluetooth device must be connected to access the submenu. When the Bluetooth device has successfully paired to the stereo the icon will be animated in the "Choose Media Device" Menu.



= **AUX Icon:** Press button A to access the AUX device submenu (page 47).



= **USB Icon:** Press button B to access the USB device submenu (page 48).





= **Radio Icon:** Press button C to access the Radio device submenu (page 50).



= **Volume Control:** Allows you to control the volume level. The arrows on the top and bottom of the volume indicate that the Quad Keypad can be used to lower or raise the volume. When pressing the Up or Down button the "Vol" icon is replaced by the volume level number.

- Press the Up button to increase the volume.
- Press the Down button to decrease the volume.

-  = **Previous Icon:** Press button D to return to the Choose Media Device Menu.
-  = **Splash Button:** Press this button once to pause the track. Press again to play.

10.6 AUX Submenu

When you press button B (while still in the Entertainment Menu) you can access the AUX/USB submenu. The Auxiliary submenu (Figure C) displays when you connect any Auxiliary or MP3 device. When this submenu is active it provides volume control only, all other functions are controlled through the connected device.



WARNING: RISK OF ELECTRICAL SHOCK HAZARD EXISTS AND EQUIPMENT DAMAGE! Never install or remove electrical devices while hands are wet or while sitting partially immersed or fully immersed in spa!

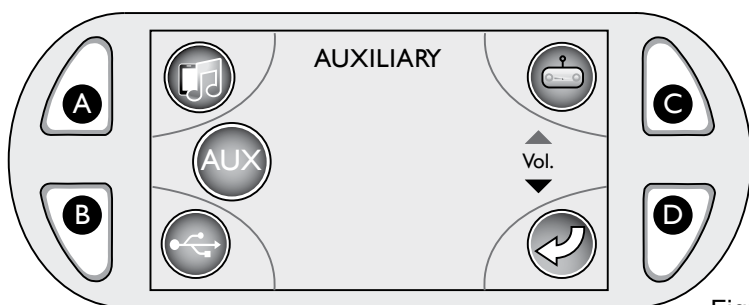







Figure C

-  **Vol.** = **Volume Control:** Allows you to control the volume level. The arrows on the top and bottom of the volume indicate that the Quad Keypad can be used to lower or raise the volume. When pressing the Up or Down button the "Vol" icon is replaced by the volume level number.
 - Press the Up button to increase the volume.
 - Press the Down button to decrease the volume.
-  = **Bluetooth Icon:** Press button A to access the Bluetooth submenu (page 46). A Bluetooth device must be connected to access the submenu.
-  = **USB Icon:** Press button B to access the USB submenu (page 48).
-  = **Radio Icon:** Press button C to access the Radio submenu (page 50).
-  = **Button D:** Press this button to return to the previous menu.

10.7 USB Submenu

When you press button B (from the Auxiliary Menu) you can access the USB submenu. The USB submenu lets you connect to a USB device (page 95). You can control the folder selection, track selection, volume, and pause/play the device.

A. Accessing a track

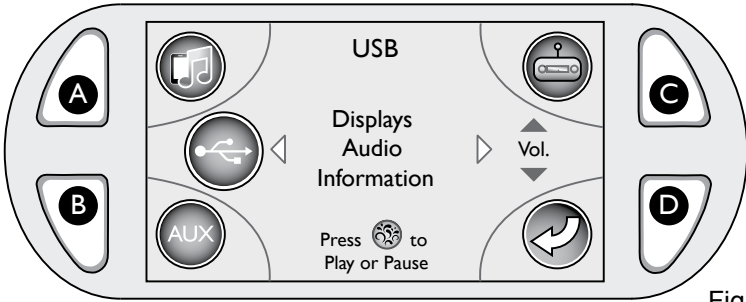

Figure D

◀ "Displays Audio Information" ▶

▶ = Audio Information: Displays the track number, artist, song, and time elapsed (if available). The arrows on either side indicate that the Quad Keypad can be used to scroll through the tracks.

- Press the Left button to move to the previous track.
- Press the Right button to move to the next track.



Vol. = Volume Control: Allows you to control the volume level. The arrows on the top and bottom of the volume indicate that the Quad Keypad can be used to lower or raise the volume.

- Press the Up button to increase the volume.
- Press the Down button to decrease the volume.



= Splash Button: Allows you to pause or play the music.

- Press the Splash button to pause when playing.
- Press the Splash button again to reactivate.



= Button A: Press this button to access the Bluetooth submenu (page 46). A Bluetooth device must be connected to access the submenu.



= Button B: Press this button to access the AUX submenu (page 47).



= Button C: Press this button to access the Radio submenu (page 50).



= Button D: Press this button to access the Folder submenu (page 49).

B. Accessing a folder

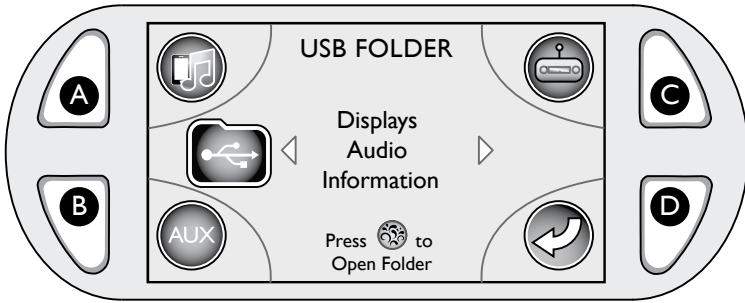

◀ "Displays Audio Information" ▶

Folder Icon: Allows you to select the folder from the USB drive. The arrows on either side indicate that the Quad Keypad can be used to scroll through the folders.

- Press the Left button to move to the previous folder.
- Press the Right button to move to the next folder.
- Once the folder is located that you would like to listen to, press the Splash button to select it. The LCD display will change to the track information (Figure D).



Splash Button: Press this button to open the folder selected.



WARNING: RISK OF ELECTRICAL SHOCK HAZARD EXISTS AND EQUIPMENT DAMAGE! Never install or remove USB device while hands are wet or while sitting partially immersed or fully immersed in spa!

10.8 FM Radio Submenu

The FM radio submenu (Figure E) gives you access to your local FM radio stations and preset stations.

A. Listening to local FM radio stations

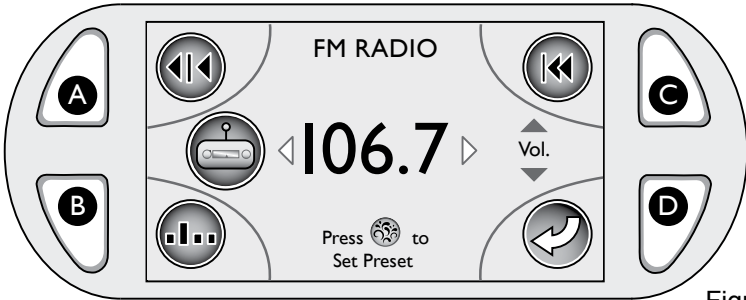

Figure E

- ◀106.7▶ = **Station Number:** Indicates the station that is currently playing. The arrows on the either side of the station number indicate that the Quad Keypad can be used to scroll through the local stations.
- Press the Left button to move slowly back through local stations.
 - Press the Right button to move slowly forward through local stations.

- ▲
Vol. = **Volume Control:** Allows you to control the volume level. The arrows on the top and bottom of the volume indicate that the Quad Keypad can be used to lower or raise the volume.
- Press the Up button to increase the volume.
 - Press the Down button to decrease the volume.

- 🔍 = **Splash Button:** Press to set a preset station. You can use the Left and Right buttons to choose the preset number you would like this station to be (page 52).

- ⏮ = **Scan Icon:** Press button A to activate the intro scan feature. The radio will scan and stop at frequencies with a strong signal for about 5 seconds, then continue scanning until button A is pressed again to stop the scan or the screen reverts back to the main menu (page 51).

- 📶 = **Preset Icon:** Press button B to access the FM preset stations. You can save up to 18 stations (page 52).

- ⏭ = **Seek Icon:** Press button C to seek through frequencies and stop at a frequency with a strong signal (page 51).

- ↶ = **Button D:** Press this button to return to the previous screen.

B. Using the scan feature

From the FM Radio Menu (Figure E) press button A to access the scan feature. The radio will scan and stop at frequencies with a strong signal for about 5 seconds then continue scanning.

1. The display will change to (Figure F) and the scan icon will be highlighted red.
2. Press the Left button to start an intro scan back through the frequencies.
3. Press the Right button to start an intro scan forward through the frequencies.
4. Press the scan button again to remain on a frequency that you would like to listen to (Figure G).
5. Press button D to return to the FM Radio Menu, Figure E.

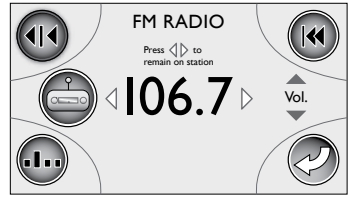

Figure F

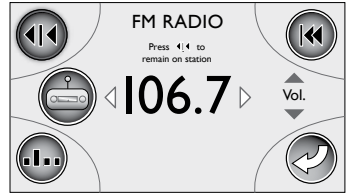

Figure G

C. Using the seek feature

From the FM Radio Menu (Figure E) press button C to access the seek feature.

1. The display will change to (Figure H) and the seek icon will be highlighted red.
2. Press the Left button to seek back through the frequencies and stop at the frequency with a strong signal.
3. Press the Right button to seek forward through the frequencies and stop at the frequency with a strong signal.
4. Press button D to return to the FM Radio Menu, Figure E.

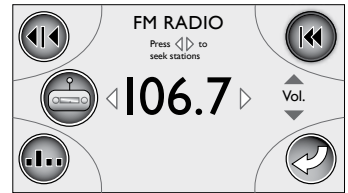

Figure H

D. Setting preset stations

Use the Quad Keypad to set stations into memory (Figure I).

1. Use the Left and Right buttons to locate a station you would like to set or use the scan and seek features.
2. Once a station has been selected press the Splash button to enter the preset submenu (Figure J).
3. Use the Left and Right buttons to assign a preset number to the station you would like to set.
4. Press the Splash button to confirm and save the changes.
5. You can save up to 18 stations. FM1, FM2 and FM3 allows six stations to be programmed for each segment.
6. Press button D to return to the FM Radio Menu.

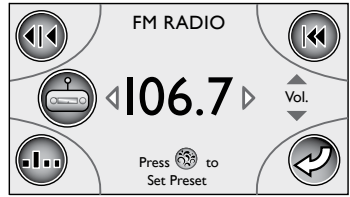

Figure I

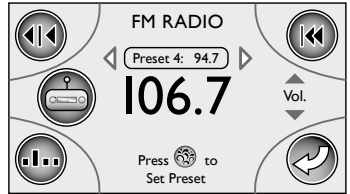

Figure J

E. Listening to preset stations

From the Radio Menu (Figure E) press button B to enter the preset submenu (Figure K).

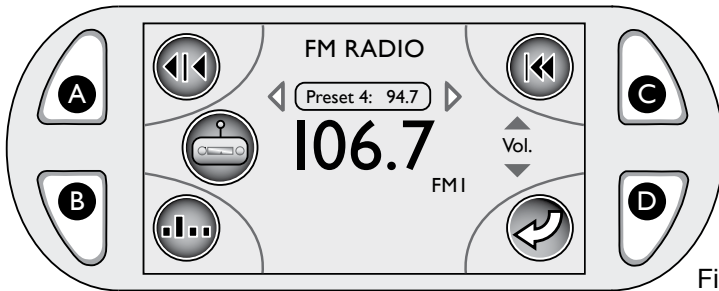

Figure K

Preset 4: 94.7

- = Preset Number:** Indicates which preset station is currently playing. The arrows on the either side of the Preset station icon indicate that the Quad Keypad can be used to scroll through the preset stations. You can set up to 18 stations.
- Press the Left button to move back through preset stations.
 - Press the Right button to move forward through preset stations.

10.9 Adjust Audio Settings Submenu

The J1000 audio system offers you the flexibility to adjust a series of audio settings. From the Choose Media Device Menu (Figure L), press the Splash button to enter the Adjust Audio Settings submenus (Figure M).

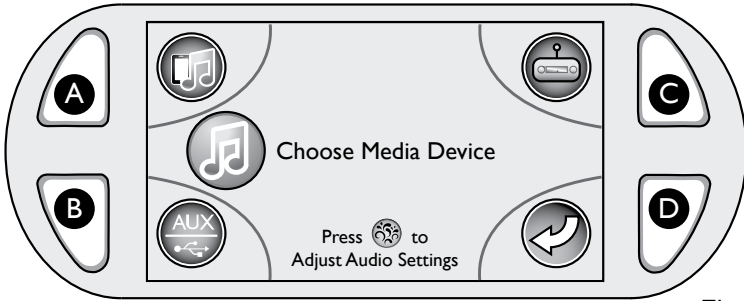

Figure L

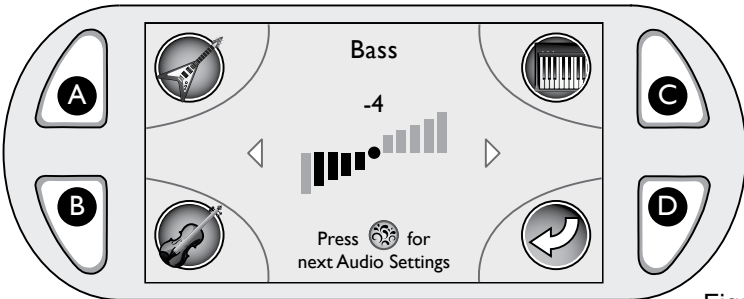

Figure M



Level Bar Icon: Indicates the adjustment level by the number of bars filled. Use the Quad Keypad to adjust the range from -5 to 5.

- Press the Left button to lower the level to a minimum of -5.
- Press the Right button to raise the level to a maximum of 5.



Rock Icon: Press button A to activate the “Rock” music setting from any of the Audio Setting Submenus.



Classic Icon: Press button B to activate the “Classic” music setting from any of the Audio Setting Submenus.



Pop Icon: Press button C to activate the “Pop” music setting from any of the Audio Setting Submenus.



Splash Button: Press this button to continue to the next Audio Setting Menu.

A. Adjusting the Bass Audio Setting

Use the Quad Keypad to adjust the range from -5 to 5 (Figure N).

1. Press the Left button to lower the bass to a minimum of -5.
2. Press the Right button to raise the bass up to a maximum of 5.
3. Press the Splash button to continue to the next Audio Setting Menu or button D to return to the Choose Media Device Menu.

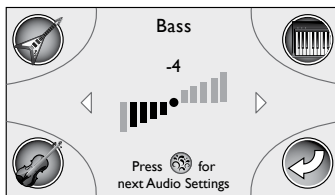

Figure N

B. Adjusting the Treble Audio Setting

Use the Quad Keypad to adjust the range from -5 to 5 (Figure O).

1. Press the Left button to lower the treble to a minimum of -5.
2. Press the Right button to raise the treble up to a maximum of 5.
3. Press the Splash button to continue to the next Audio Setting Menu or button D to return to the Choose Media Device Menu.



Figure O

C. Adjusting the Balance Audio Setting

Use the Quad Keypad to adjust the range from 10L to 10R (Figure P).

1. Press the Left button to adjust the balance from the right side to the left side (10L).
2. Press the Right button to adjust the balance from the left side to the right side (10R).
3. Press the Splash button to continue to the next Audio Setting Menu or button D to return to the Choose Media Device Menu.



Figure P

D. Adjusting the Fader Audio Setting

Use the Quad Keypad to adjust the range from 10F to 10R (Figure Q).

1. Press the Left button to adjust the fade setting from the front to the rear (10R).
2. Press the Right button to adjust the fade setting from the rear to the front (10F).
3. Press button D to return to the Choose Media Device Menu or the Splash button to return to the Bass Setting Menu (Figure N).



Figure Q

E. Rock Audio Setting

From the Audio Settings Menu, press button A to activate the rock audio settings (Figure R).

1. Programmed audio settings are Bass (+3) and Treble (+1).
2. If this audio setting is selected do not press any button and in 15 seconds the display will return to the Choose Media Device Menu.
3. Press button B to select the Classic Setting.
4. Press button C to select the Pop Setting.
5. Press button D to return to the Bass Setting Menu.

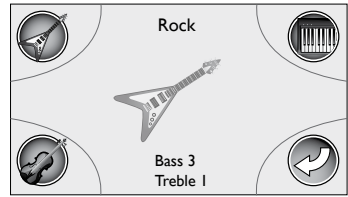

Figure R

F. Classic Audio Setting

From the Audio Settings Menu press button B to activate the classical audio settings (Figure S).

1. Programmed audio settings are Bass (+1) and Treble (+1).
2. If this audio setting is selected do not press any button and in 15 seconds the display will return to the Choose Media Device Menu.
3. Press button A to select the Rock Setting.
4. Press button C to select the Pop Setting.
5. Press button D to return to the Bass Setting Menu.

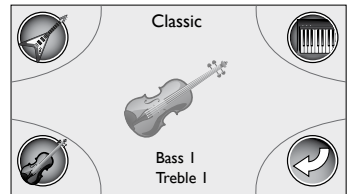

Figure S

G. Pop Audio Setting

From the Audio Settings Menu press button C to activate the pop audio settings (Figure T).

1. Programmed audio settings are Bass (-2) and Treble (-1).
2. If this audio setting is selected do not press any button and in 15 seconds the display will return to the Choose Media Device Menu.
3. Press button A to select the Rock Setting.
4. Press button B to select the Classic Setting.
5. Press button D to return to the Bass Setting Menu.



Figure T

11.0 Operating Instructions

11.1 J-1000™ Control Panel

Your Jacuzzi spa is equipped with a J-1000™ control panel, massage selectors, and air control knobs located on the top rim of the spa (pages 23-40). These controls let you operate many of the special functions of your Jacuzzi spa. When you press button B from the Main Menu, you will enter the Jets Pump Submenu (Figure A).

Note: Once you enter the Jets Pump Submenu, all the pumps will activate. You can turn off all or individual jets pump's by pressing the Splash button or the button next to the jets pump.

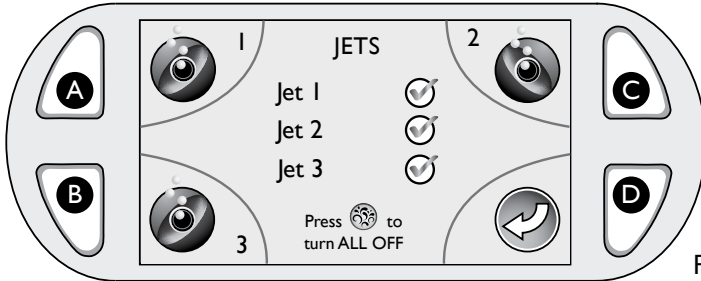

Figure A



= **Jets Pump 1 Icon**



= **Jets Pump 2 Icon (If applicable)**



= **Jets Pump 3 Icon (If applicable)**



= **Button A:** Turns Jets pump 1 on and off.



= **Button B:** Turns Jets pump 3 on and off (If applicable).



= **Button C:** Turns Jets pump 2 on and off (If applicable).



= **Button D:** Press this button to return to the Main Menu.

11.2 Activate Jets Pump

From the Main Menu (page 42), press button B to enter the Jets Pump Submenu. The LCD screen will display the Jets Pump Submenu (Figure A). From this menu you can control the pumps in the following sequence:

Note: If the pump(s) surge, please check the QuickDrain cap to make sure it is tighten and correctly installed.

1. Press the Splash button to turn all jet pumps off.
2. Press button A to turn pump #1 off.
3. Press again to activate pump #1.
4. Press button B to turn pump #3 off.
5. Press again to activate pump #3.



JETS ICON
WHEN OFF



JETS ICON
WHEN ON

6. Press button C to turn pump #2 off.
7. Press again to activate pump #2.

The pumps will move from an “ON” () state into an “OFF” state.

Auto Turn Off — Anytime a pump has been manually turned on, it will automatically turn off after approximately 20 minutes. If at this time you desire more jet operation you may simply turn the pump(s) back on.

11.3 Activate Lights

From the Main Menu (page 42), press button C to enter the Light's submenus. The LCD screen will display the Lighting icons (Figure B). From this menu you can control the interior lighting (waterfall, footwell, IX logo, pillows and cup holder lights). The spa is equipped with two light modes; 1) Solid Color or 2) Light Rotation mode for interior lighting.

Note: The interior lights automatically turn off after 2 hours. They can be reactivated if needed.

Figure B

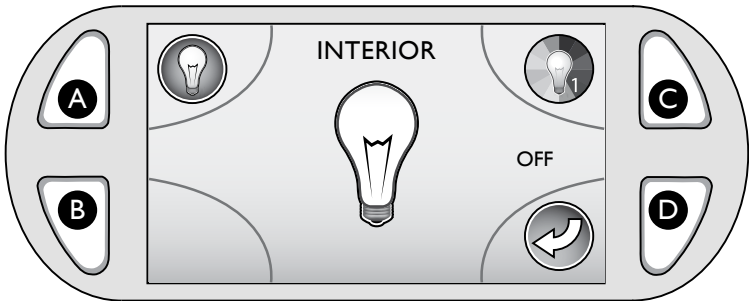

= **Interior Lights Icon**



= **Interior Light Rotation Icon**



= **Button A:** Press this button to access the interior lights menu.



= **Button B:** (button is not used).



= **Button C:** Press this button to access the interior light rotation menu.



= **Button D:** Press this button to return to the Main Menu.



= **Color selection:** Allows you to choose or scroll through the colors by using the Quad Keypad (page 41).



= **Brightness:** Allows you to control the intensity of the light by using the Quad Keypad.



= **Light Rotation selection:** Allows you to control the speed of the light rotation for interior by using the Quad Keypad.

A. To Access the Interior Solid Color Mode:

1. Press button A to activate the solid color mode.

Note: The default color and intensity will always be the last color and intensity used.

2. Press again to turn off.

3. Press either the Left or Right button of the Quad Keypad to scroll through or select one of the 7 different colors (Figure C).

- Press the Left button to move forward in the color sequence. (Blue-Cyan-Green-Yellow-Orange-Red-Purple-Blue).
- Press the Right button to move backwards in the color sequence. (Blue-Purple-Red-Orange-Yellow-Green-Cyan-Blue).

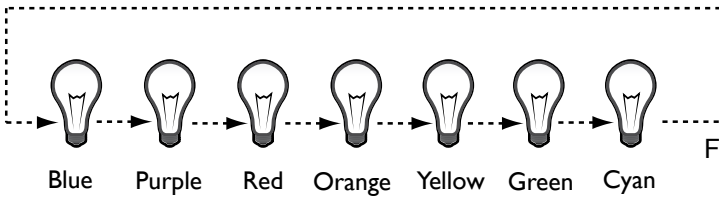

Figure C

4. The intensity of the lights can be controlled in both the solid color or light rotation modes by using the Quad Keypad (Figure D).

- Press the Up button to increase the intensity in 25% increments.
- Press the Down button to decrease the intensity in 25% increments.

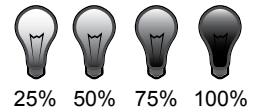

Figure D

Note: The intensity range is from 25% to 100%, in increments of 25%. As the intensity is increased/decreased the bulb will darken/lighten to reflect the effect. Intensity defaults to the last setting used.

B. To access the Interior Light Rotation Mode

The lighting performance can be user enhanced by controlling the intensity and frequency effects as follows:

1. Press button C to enter the Light Rotation Mode (Figure E).

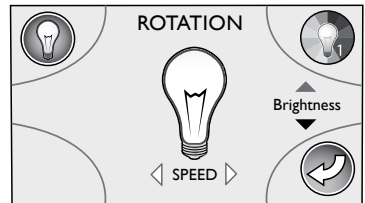

Figure E

2. To control the speed of the light rotation use the Quad Keypad by pressing the Right button to increase the speed of the light rotation speed from 1, 2, 3, 4, 5 or 6 (60, 33, 18, 10, 5 or 3

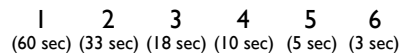

Figure F

seconds, respectively) or press the Left button to decrease the speed of the light rotation from 6, 5, 4, 3, 2 or 1 (3, 5, 10, 18, 33 or 60 seconds, respectively). On the LCD display you will see a number from 1-6 to indicate the speed selection (Figure F).

3. To increase or decrease light intensity, use the Quad Keypad as follows:
 - Press the Up button to increase the intensity in 25% increments.
 - Press the Down button to decrease the intensity in 25% increments.

Note: The intensity range is from 25% to 100%, in increments of 25%. As the intensity is increased the bulb will darken to reflect the effect (Figure D, page 58). Intensity defaults to the last setting used.
4. Press button A to deactivate the light rotation mode and select a solid color (the last color and intensity used).
5. Press button C to turn off the interior lights.
6. Press button D to return to Main Menu.

11.4 Adjusting Individual Jet Flow

The water flow to certain jets in your spa can be increased or decreased by rotating the outside jet face.

Note: Always keep at least 6 adjustable jets open at all times.



11.5 Adjusting PowerPro™ MX2 Jets

Tilt PowerPro MX2 Jet nozzle to angle of choice as desired. Rotate nozzle clockwise to reduce flow volume from jet or rotate counterclockwise to increase flow volume.

Note: Always keep at least 6 adjustable jets open at all times.



11.6 Adjusting RX Jets

Rotate the outside jet face clockwise to decrease or shut off water flow. Turn counterclockwise to turn on or increase water flow.

Note: Always keep at least 6 adjustable jets open at all times.



11.7 WaterColour™ Waterfall Control

Turn waterfall control valve (pages 23-40) counterclockwise to increase waterfall output. Turn control valve clockwise to decrease or turn off waterfalls.



11.8 Air Controls

Certain jet systems have their own air control. Each control introduces air into the water lines that supply that specific jet group (pages 23-40). Simply rotate any air control clockwise to open or rotate counterclockwise to close. To minimize heat loss, all air controls should be closed when the spa is not in use.



11.9 Selecting the Desired Massage Action

Your Jacuzzi spa is equipped to allow you to customize the massage action you desire. Each model incorporates a massage selector that allow you to customize the massage and performance by diverting water between various jet systems. Simply turn massage selector to position A (Combo), B, or C to divert water pressure to various jet groups.

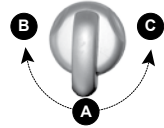

Note: The massage selector valve(s) is designed to operate in positions A (Combo), B, and C for optimum performance. It is considered normal for sound levels within the valve to vary between positions due to the large amounts of water flowing through it. For optimum filtration benefits, leave the valve in position A when spa is covered. Select position B or C for maximum jet performance during spa use.

11.10 Indicator Light

The indicator light located on the front cabinet panel of the spa is an early detection system that will notify you when the spa needs immediate attention. A



solid white light indicates that all operations are normal. A solid red light indicates that immediate attention is required to clear or fix an error code. For a detailed explanation refer to Section 17.0, page 88. Always insist on genuine Jacuzzi replacement parts.

11.11 Optional J-1000™ Audio System

Jacuzzi models equipped with the optional audio system offer enhanced hot tub enjoyment with an integrated state-of-the-art audio system. These models include an integrated FM/BT/USB/Bluetooth player receiver, a wireless remote, high-quality spa engineered speakers for unsurpassed sound quality and long-life, and a powered subwoofer for an enhanced acoustical experience.



12.0 Programming Instructions for Settings 1 Menu

Your Jacuzzi spa is equipped with three settings menus that allow you to program and activate different components of the spa. In the “Settings 1” menu you can program the Heating, the CLEARRAY® Water Purification System (UV), and the check/clean filter reminder. You can also access the “Settings 2” menu (Section 13.0, page 67) and the Filter Boost function.

Your Jacuzzi spa is equipped with three modes of heating. An energy saving heating cycle called “Eco-Mode.” An automatic mode called “Auto-Heating,” where the spa’s temperature is maintained at all times by the “Setpoint.” Lastly a “Programmable” mode, where the spa will only activate the heater at set times programmed by you. To activate either mode follow the procedures below.

To access the Settings 1 Menu:

1. Press button D from the Main Menu (page 42) to enter the Settings 1 Menu (Figure A).
2. From this menu you can choose a heating cycle, set the timer for the CLEARRAY Water Purification System, and set the change/clean filter reminder.

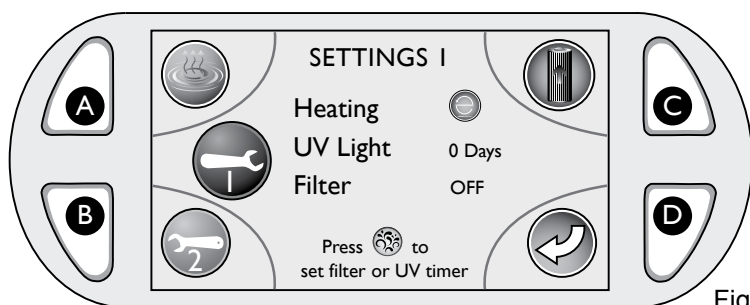

Figure A



= **Heating Menu Icon:** Press button A to access the heating programs.



= **Filter Boost Icon:** Press button C to activate the filter boost cycle. All the jets pumps will activate for 20 minutes for additional filtering. The display will read “Filter Boost Enabled” and revert to the “Settings 1” Menu within 5 seconds.



= **Settings 2 Menu Icon:** Press button B to access the additional programming features.



= **Previous Icon:** Press button D to return to the previous menu.



= **Splash Button:** Press to access the Set Filter or UV Timer Submenus.

12.1 Programming the Eco-Mode Heating Mode

Eco-Mode is an energy saving heating program. By heating the spa in the non-peak hours, you conserve electricity. While in Eco-Mode the spa is programmed to heat during the hours of 5:00 PM to 7:00 AM on a daily basis. The functions for this mode cannot be altered.

To access the Eco-Mode Submenu:

1. From the “Settings 1” menu (Figure A), press button A to enter the Heating programs. The menu appears with Eco-Mode selected. The display will change to Figure B.
2. If you elect to use this mode, press the Splash button on the Quad Keypad. The display will confirm your selection and Figure C will be displayed briefly then return to the Heating submenu.
3. To exit the submenu, press button D to return to the Settings 1 menu.
4. If you have programmed the Eco-Mode cycle you will see the Eco-Mode icon (☺) next to word “Heating” on the display (Figure A).

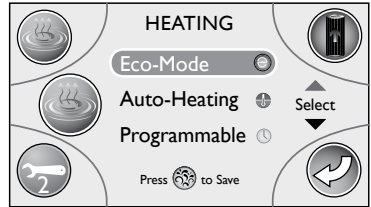

Figure B

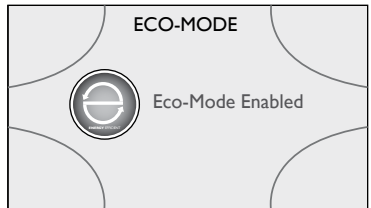

Figure C

12.2 Programming the Auto-Heating Mode

Auto-Heating mode is typically selected by customers in cold climates where heat up times are extended due to lower ambient temperatures. In this mode, water temperature is regulated by the set temperature which activates the heater automatically as needed.

Note: If you elect to use Auto-Heating, you can skip this section. Auto-Heating is the default spa setting.

1. Press button B to enter the Heating Menu (Figure D). Use the Quad Keypad to down button to select Auto-Heating.
2. If you elect to use this mode, press the Splash button on the Quad Keypad. The display will confirm your selection and Figure E will be displayed briefly then return to the Heating submenu.

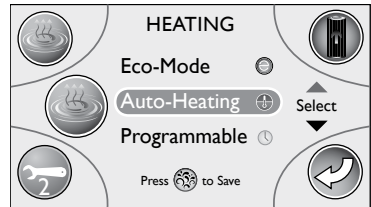

Figure D

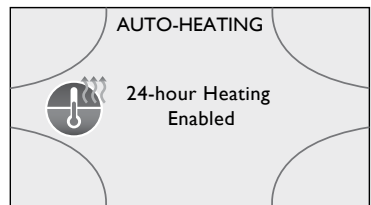

Figure E

- To exit the submenu, press button D to return to the Settings 1 Menu.
- If you have programmed the Auto-Heating cycle you will see the Thermometer with wavy lines icon next to word Heating on the display (Figure F).

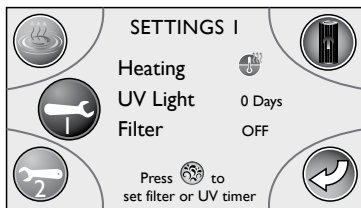

Figure F

12.3 Programmable Heating Mode

Programmable heating mode is typically selected by customers in warm climates where heat up times are minimized due to higher ambient temperatures. In this mode, the water temperature is regulated by the set temperature only when a programmed heating cycle is running, unless in summer logic page 68.

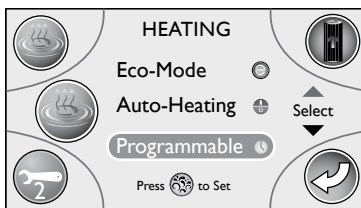

Figure G

From the Heating Menu (Figure B, page 62), use the Quad Keypad Down button to select the programmable setting, then press the Splash button to enable selection, Figure G.

A. Program A Heating Mode

- You are allowed to have two separate programs in the programmable mode, you can elect to use both or just one. Press the Splash button to enter the submenus for “Program A” (Figure H).

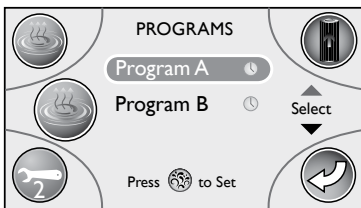

Figure H

- From this menu (Figure I), you can set the days, times, and duration. With “Day Settings” selected press the Splash button on the Quad Keypad to access the submenu.



Figure I

- When you enter the submenu (Figure J), you can choose the day(s) you would like “Program A” to run for a heating cycle. Press the Up or Down button (on the Quad Keypad) to scroll through and choose the days you would like the heater to activate. Press the Left or Right button to turn “ON” (☑) or “OFF” the heater for that day.

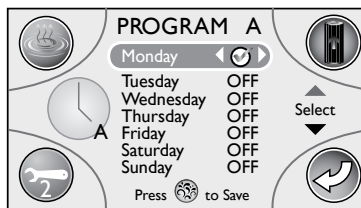

Figure J

4. Press the Splash button to save settings. Then the display will revert to the Program A menu (Figure I).
5. Press the Down button on the Quad keypad to select “Start Time” (Figure K). Press the Left or Right button on the Quad Keypad to select the time you wish the spa to run. Press the Down button to access the “Duration” submenu.

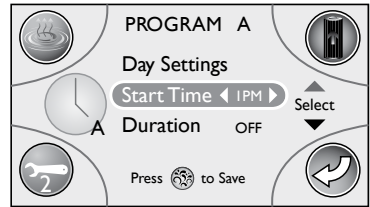

Figure K

Note: If you are using a standard 12-Hour period, you will see the hour displayed as “1PM.” For the 24-Hour period it will read “1300.”

6. Now you will need to adjust the cycle “Duration” (Figure L). Cycle duration range is adjustable from 0 (OFF) to 6 hours. Press the Left or Right button on the Quad Keypad to make adjustments in increments of 1 hour.

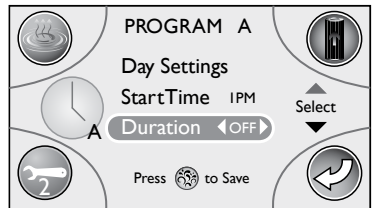

Figure L

Note: The default “Duration” is OFF.

7. Press the Splash button on the Quad Keypad to save your changes and return to the Heating Menu. At this point you can program a Secondary Heating Mode (Program B) or press button B to enter the “Settings 2” Menus (Section 13.0, page 67).

B. Program B Heating Mode

1. To program the Secondary Heating mode press the Down button on the Quad Keypad to access the “Program B” (Figure M) settings. Press the Splash button to enter the submenus for Program B.

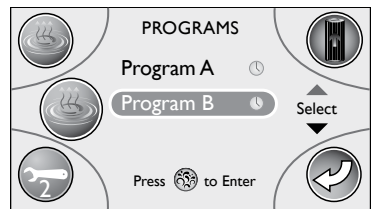

Figure M

2. From this menu (Figure N), you can set the days, times, and duration. With “Day Settings” selected, press the Splash button on the Quad Keypad to confirm selection.

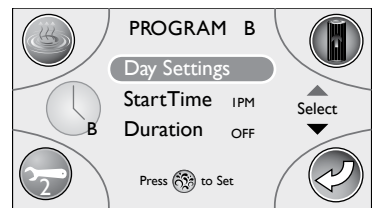

Figure N

- When you enter the submenu (Figure O), you can choose the day(s) you would like “Program B” to run for a heating cycle. Press the Up or Down button (on the Quad Keypad) to scroll through and change the days you would like the heating to activate. Press the Left or Right button to turn “ON” (☑) or “OFF” the heating for that day.

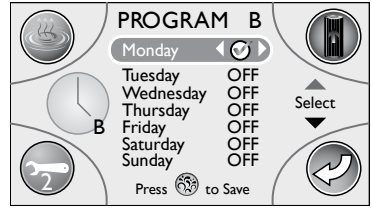

Figure O

- Press the Splash button to save settings. Then the display will revert to the Program B Menu (Figure P).
- Once back to the “Program B” Main Menu, press the Down button on the Quad Keypad to select “Start Time” (Figure P). Press the Left or Right button on the Quad Keypad to select the time you wish the spa to run. Press the Down button on the Quad keypad to access the “Duration” setting.

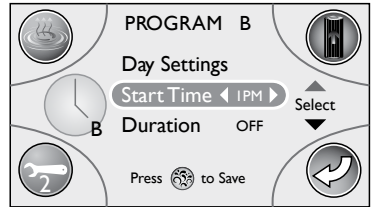

Figure P

Note: If you are using a standard 12-Hour period, you will see the hour displayed as “1PM.” For the 24-Hour period it will read “1300.”

- Now you will need to adjust the “Duration” (Figure Q) of the cycle. The duration range is from 0 (OFF) to 6 hours. Press the Left or Right button on the Quad Keypad to make your adjustment(s) in increments of 1 hour.

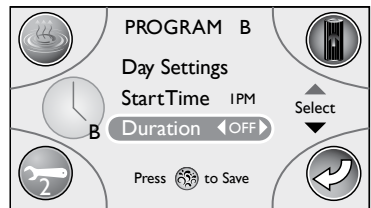

Figure Q

Note: The default “Duration” is OFF.

- Press the Splash button on the Quad Keypad to save your changes and return to the Heating Menu.
- Press button D to exit the Heating Menu and return to the Settings 1 Main Menu. If you have programmed both heating cycles and the settings have been accepted, you will see the two program icons next to word “Heating” on the display (Figure R). If only one cycle was programmed, there will only be one icon.

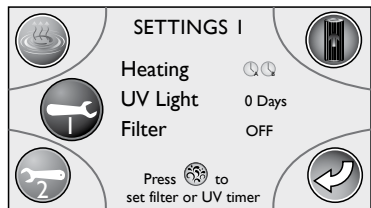

Figure R

12.4 Clean-Up “Blow-Out” Cycle

The clean-up cycle occurs once per day in all Heating modes at 12:00 (noon) for two minutes. This is not user programmable. Each jets pump activates for one minute to circulate any water in the plumbing unless a pump has just finished a 20 minute time out, it will not automatically activate for the clean-up cycle. Be aware, the factory programmed clean-up cycle cannot be canceled or altered!

12.5 Programming the CLEARRAY® timer

1. Press the Splash button to activate the “UV timer” (Figure S).
2. Press the Left button on the Quad Keypad to set the “UV timer” to 365 days (Figure T).

Note: The UV timer counts down by days not usage. The days are store in memory if the power is interrupted. The timer will only reset once it counts down to “0 Days.”

3. Press the Splash button to confirm and save your selection or press the Down button to program the “Check Filter” timer (Section 12.6).
4. When the timer expires, a message will appear on the Main Menu display (Figure U). The UV bulb must be replaced (page 84) and the timer must be reset. Follow the instructions above to reset the UV timer.

Note: When the timer expires, the indicator light will turn red. The bulb must be replaced and the timer reset. To reset the timer prior to the 365 days, press and hold the Up button. Then press the Left or Right buttons in increments of 10 days.

12.6 Setting the Check Filter Reminder

1. Press the Splash button to access the “set filter timer” (Figure V).
2. Press the Left or Right button on the Quad Keypad to scroll the number of days you would like the reminder to appear so the filters and polishing bag can be cleaned or replaced (Figure W).

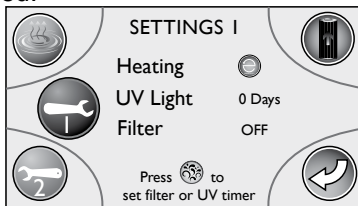

Figure S

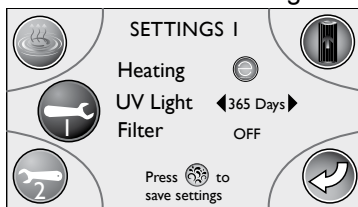

Figure T

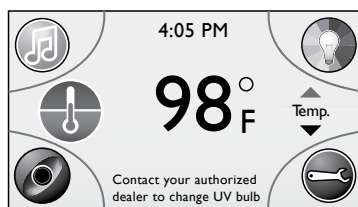

Figure U

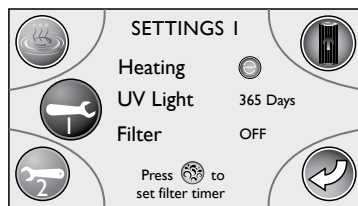

Figure V

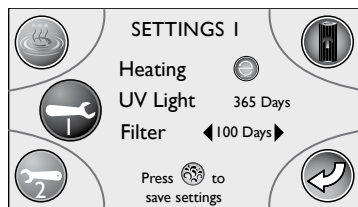

Figure W

3. Press the Splash button to confirm and save your selection.
 4. When the set time period expires, the “Please check filter!” message will appear on the Main Menu display (page 91). The reminder must be reset when the time allotted expires.
- Note:** The time range is from 10 to 365 days in increments of 10 days or you can elect to turn the feature “OFF.”

13.0 Programming Instructions for Settings 2 Menu

The “Settings 2” screen allows you to program the Primary Filter mode, Secondary Filter mode and access the “Settings 3” Submenus.

To access the “Settings 2” Menu:

1. From the “Settings 1” Menu (Figure A), press button B.
2. The “Settings 2” Menu will appear (Figure B).

Note: You can return to the factory default filtration modes by pressing the Splash button on the Quad Keypad while in the Settings 2 Main Menu (Figure B) at any time, Section 17.0, page 91.

Figure A

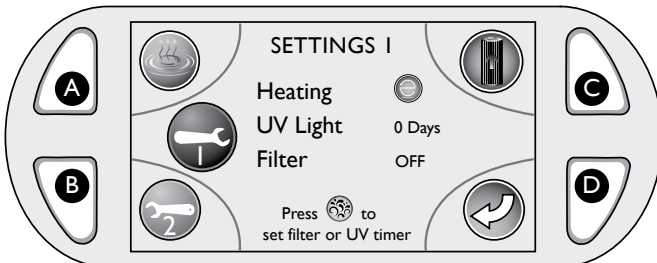
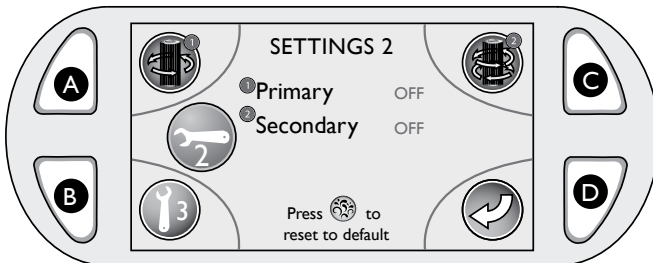

Figure B



= **Primary Filter Cycle Icon:** Press button A to access the Primary filtration submenus.



= **Secondary Filter Cycle Icon:** Press button C to access the Secondary filtration submenus.



= **Settings 3 Menu Icon:** Press button B to access the “Settings 3” Submenus.



= **Previous Icon:** Press button D to go to the previous menu.

13.1 Programming the Primary Filter Cycle

1. To program the Primary Filter cycle press button A. This cycle is mainly used to alter the pre-programmed 12-Hour running period of the circulation pump. The 12-Hour cycle is from 12:00 AM to 12:00 PM. (If you would like to leave the circulation pump as is, then skip this section).



Figure C

Upon entering the Primary submenu the “Start Time” will be selected (Figure C).

2. Press the Left or Right button on the Quad Keypad to choose the hour you want the circulation pump to start running.

Note: If you are using a standard 12-Hour period, you will see the hour displayed as “1PM.” For the 24-Hour period it will read “1300.”

3. Now you will need to adjust the “Duration” (Figure D) of the cycle. Press the Down button to select “Duration.” Press the Left or Right button on the Quad Keypad to make adjustments in increments of 1 hour. Press the Splash button on the Quad Keypad to save hour and duration selections and return to the Settings 2 Main Menu (Figure B, page 67).

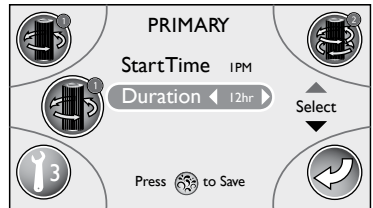

Figure D

Summer Logic: In warm weather, the water temperature in the spa may exceed the set temperature. This condition may occur due to heat transference from the filter/circulation pump and jets pumps. If the water temperature is higher than 95°F (35°C) and rises two degrees above the set temperature, a “Summer Logic” condition occurs that deactivates the filter/circulation pump and CLEARRAY®. This safety feature cannot be altered! The filter/circulation pump and CLEARRAY® will remain off until the water temperature cools to the set temperature (except between 9am-11am when the filter/circulation pump runs for it’s mandatory 2 hour cycle.) To help prevent a “Summer Logic” condition, it may be necessary to reduce filter/circulation pump cycles run times in warm weather.

13.2 Programming the Secondary Filter Cycle

1. To program the Secondary Filter cycle, press button C (Figure B, pg. 67). This cycle will activate the main jet pump to run for additional filtration when programmed (Figure E). If you choose not to use this feature, please skip this section.

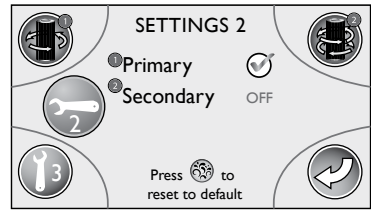

Figure E

2. When you enter the Secondary Filter Cycle submenu, the “Day Settings” will be selected (Figure F). From this menu, you can set the day, time, and duration. Press the Splash button on the Quad Keypad to confirm selection.

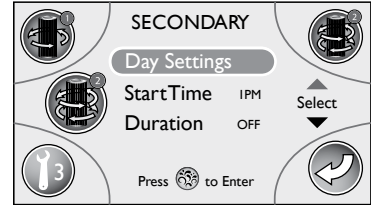

Figure F

3. You can choose the day(s) you would like to run a secondary filter cycle (Figure G). Press the Up or Down button on the Quad Keypad to scroll through and change the days you would like the filtration to run. Press the Left or Right button to turn “ON” (☑) or “OFF” the filtration for that day.



Figure G

4. Press the Splash button to save settings. Then the display will revert to the Secondary Program Menu (Figure H).
5. Press the Down button on the Quad Keypad to select “Start Time” (Figure H). Press the Left or Right button on the Quad Keypad to select the time you wish the spa to filter. Press the Down button on the Quad keypad to access the “Duration” setting.

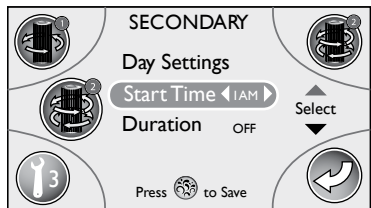

Figure H

Note: If you are using a standard 12-Hour period, you will see the hour displayed as “1PM.” For the 24-Hour period it will read “1300.”

- Now you will need to adjust the filter cycle “Duration” (Figure I). The duration range is from 0 (OFF) to 120 minutes. Press the Left or Right button on the Quad Keypad to make your adjustments in increments of 15 minutes.

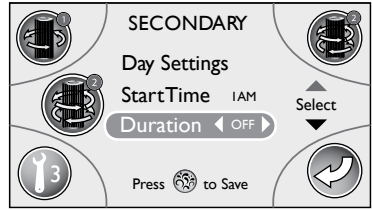

Figure I

- Press the Splash button on the Quad Keypad to save the selection. Then press button D to return to the “Settings 2” Main Menu (page 67) and continue on to the “Settings 3” Main Menu.

14.0 Programming Instructions for Settings 3 Menus

The “Settings 3” screen allows you to program the Language, Date and Time and to Lock/Unlock the spa.

To access the “Settings 3” Menu:

- From the “Settings 2” Menu (Figure A), press button B.
- The “Settings 3” Menu will appear (Figure B).

Figure A

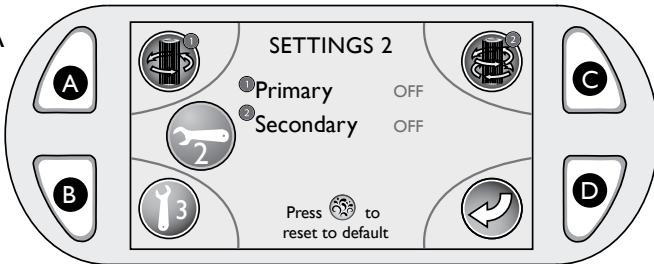
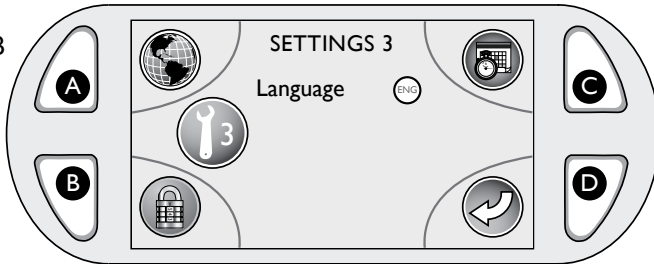

Figure B



= **Language Icon:** Press button A to access the Language submenu.



= **Time Icon:** Press button C to access the Date and Time submenus.

Note: The Date and Time submenus will default to the last submenu accessed.



= **Date Icon:** Press button C to access the Date and Time submenus.

Note: The Date and Time submenus will default to the last submenu accessed.



= **Lock/Unlock Icon:** Press button B to lock and unlock the control panel.



= **Previous Icon:** Press button D to go to the previous menu.

14.1 Choosing the Language

1. Press button A to enter the Language submenu. The screen will change to the Figure C.

Note: English is the default language.

2. Use the Quad Keypad to switch between English and Français by pressing the Up or Down button.

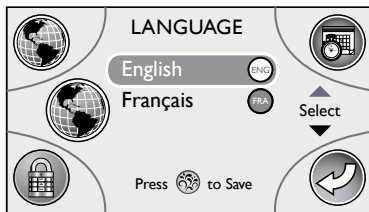

Figure C

3. Press the Splash button to save your change. The screen will return to the Settings 3 Main Menu.

14.2 Setting the Date

1. Press button C (Figure B, page 70) to enter the date menu. The screen will open with the “Set Year” selected Figure D. Press the Left or Right button on the Quad Keypad to scroll through selection. Once the correct year is displayed, press the Down button on the Quad Keypad to access the month selection.



Figure D

2. With the “Set Month” selected (Figure E), use the Left or Right button on the Quad Keypad to scroll through selection. Once the correct month is displayed, press the Down button to access the day selection.



Figure E

- With the “Set Day” selected (Figure F), press the Left or Right button on the Quad Keypad to scroll through selection. Once the correct day is displayed, press the Splash button to save your changes. The display will change to the Time Setting Submenu.



Figure F

14.3 Setting the Time

- The display will open with “Set Clock” selected (Figure G). Press either the Left or Right button on the Quad Keypad to choose either a 12-Hour or 24-Hour display. Then press the Down button to access the hour selection.



Figure G

- With “Set Hour” selected (Figure H), press the Left (decrease) or Right (increase) button on the Quad Keypad to scroll through the selection. Once the correct hour is displayed, press the Down button to access the minutes selection.



Figure H

Note: If you are using a standard 12-Hour period, you will see the hour displayed as “1PM.” For the 24-Hour period it will read “1300.”

- With “Set Min.” selected (Figure I), press the Left (decrease) or Right (increase) button on the Quad Keypad to scroll through the selection. Once the correct minutes are displayed, press the Splash button to save your changes. Press button D to return to the “Settings 3” Main Menu.



Figure I

14.4 Locking and Unlocking the Topside

1. From the “Settings 3” Menu (Figure J), press button B to access the Lock feature. The Lock Menu opens up to a padlock (Figure K). This feature accepts a three digit code to lock and unlock the panel from unauthorized use.

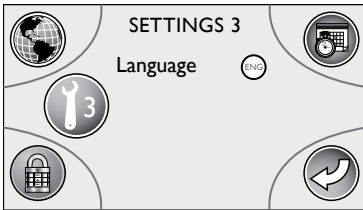

Figure J

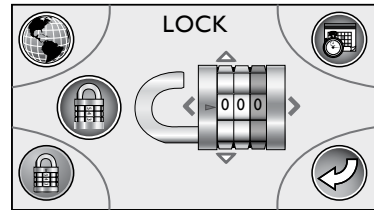

Figure K

2. To set each “lock code” digit, use the Left or Right button on the Quad Keypad. To change a number, press the Up or Down button to scroll through selection 0-9 (Figure L). Once you have selected a 3-Digit code, press the Splash button to save your changes. When the spa is locked the LCD display will look like Figure M.

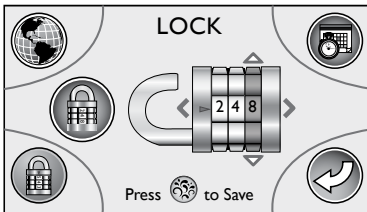

Figure L

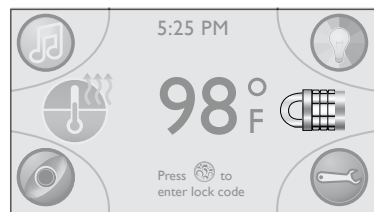

Figure M

3. To Unlock the topside panel, press the Splash button on the Quad Keypad. The lock icon will appear on the LCD display (Figure N). Press the Up, Down, Left and Right Quad Keypad buttons to enter “lock code” from left to right. After all three lock code digits are entered, press the Splash button to access the Main Menu (if correct code was entered).

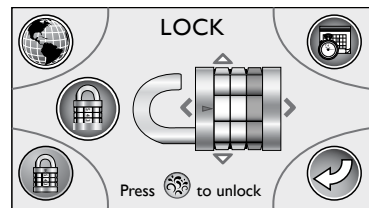

Figure N

Note: In case the lock/unlock code is lost or forgotten, a default code of 772 can be used to unlock the panel.

15.0 Spa Maintenance

Proper and regular maintenance of your spa will help it retain its beauty and performance. Your authorized Jacuzzi dealer can supply you with all the information, supplies, and accessory products you will need to accomplish this.



DANGER: RISK OF SEVERE INJURY OR DROWNING BY ENTRAPMENT!

- Keep hair, loose articles of clothing or hanging jewelry away from suction fittings, rotating jets or other moving components to avoid entrapment that could lead to drowning or severe injury.
- Never use the spa unless all suction guards, filter, filter lid, or skimmer assembly are installed to prevent body and/or hair entrapment.
- Never operate or use the spa if the filter, filter lid, or skimmer assembly are broken or any part of the skimmer assembly is missing. Please contact your dealer or nearest service center for service.
- The suction fittings and suction covers in this spa are sized to match the specific water flow created by the pump(s). If it is necessary to replace the suction fittings, suction covers or pump(s), be sure that the flow rates are compatible and are in compliance with the VGB Safety Act, page 2.
- Never replace a suction fitting or suction cover with one rated less than the flow rate marked on the original suction fitting. Using improper suction fittings or suction covers can create a body or hair suction entrapment hazard that may lead to drowning or severe injury.
- Owners must alert all spa users to the potential risk of Hair, Limb, Body, Evisceration (disembowelment), and Mechanical Entrapment, page 6.

15.1 Cleaning the Filter Cartridges

A programmable “Please Check Filter” reminder appears on the control panel display after a specified number days to remind you to clean the skimmer filter and to check the polishing bag filter. This reminder must be reset at each filter cleaning interval.

Refer to Section 12.6 (page 66) for additional information and programming details. Your new spa is equipped with an advanced 2-Stage filtration system. Fine debris are filtered by the circulation pump drawing water through the ProClarity™/ProClear™ skimmer and pleated filter cartridges 12 hours (unless programmed otherwise). Large debris are filtered when jets pump 1 is running when the spa is in use or during

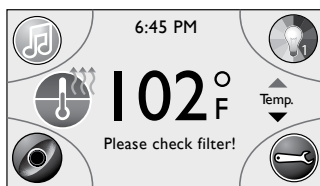

a programmed filter cycle. These pumps draw water from footwell suction fitting and through a secondary water polishing bag filter and additional filter.

A. Cleaning the filters and filter bag

To ensure optimum performance:

1. The ProClarity™ filter cartridge (A) must be cleaned every three months and replaced every two years.
2. The ProClarity Depth filter (B) must be replaced every 3 to 4 months.
3. The ProClarity filter canister (C) can be rinsed when the filters are cleaned.
4. The ProClear II skimming filter cartridge (D) must be cleaned every three months and replaced every two years.
5. The ProClarity debris bag (E) should be checked and emptied monthly.

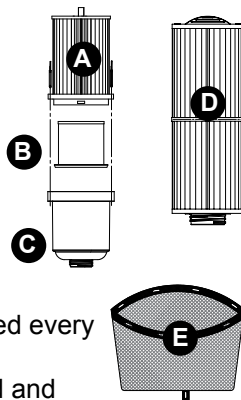

To accomplish this, refer to the following filter cleaning procedure.

Note: Do not attempt to wash the ProClarity depth filter (B) and the ProClear/ProClarity debris bag (E) or it will come apart!

B. Cleaning the Filters/Debris bag:

A **DANGER: TURN POWER TO SPA OFF! TO DECREASE RISK OF DEATH, DROWNING, OR ENTRAPMENT, NEVER OPERATE SPA WHEN FILTER IS NOT PROPERLY INSTALLED OR IF SKIMMER ASSEMBLY IS DAMAGED OR ALTERED!**



B

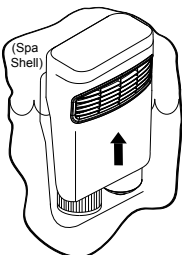

Lift the cover upward to access filter cartridges.

C

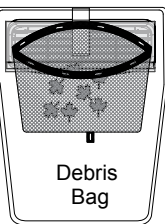

Remove the ProClarity debris bag from clips and then clean out debris.

D

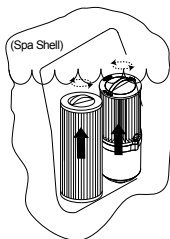

Rotate each filter cartridge handle counterclockwise to unthread from mating wall fitting.

E

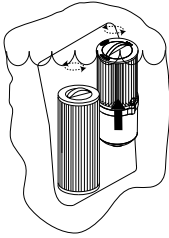

Lift unthreaded filter cartridge from skimmer well.

F

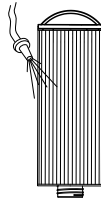

Cartridge 1

If used, remove the chemical feeder as instructed prior to rinsing the filter cartridge. Rinse debris from filter pleats using a garden hose and high-pressure nozzle. Start at the top and work downward towards handle. Repeat until all pleats are clean.

G

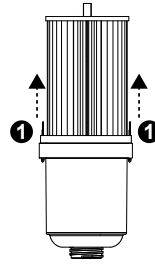

Remove the filter pins **1** in order to separate the ProClarity filter and canister.

H

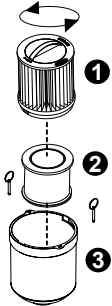

Once the filter pins are removed, rotate the filter cartridge handle counterclockwise to unthread from the filter canister. You can clean the filter **1** and canister **3**, but you must replace the ProClarity Depth Filter **2** every 3 to 4 months.

I

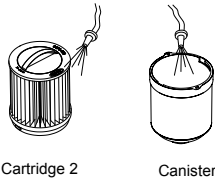

Rinse debris from filter pleats using a garden hose and high-pressure nozzle. Start at the top and work downward towards handle. Repeat until all pleats are clean. Rinse out any debris from the canister.

J

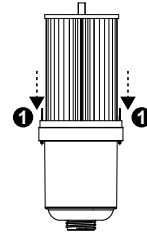

Reassemble the ProClarity Filter. Remember to replace the depth filter with a new one. Once the filter is assembled, secure it with the filter pins **1**.

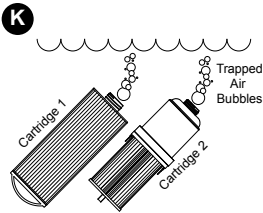

Submerge both filter cartridges in spa. Tilt threaded end upward to remove trapped air bubbles, then keep cartridges submerged to prevent air entrapment during installation.

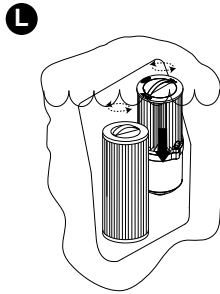

Place each cartridge back into skimmer well, then rotated each cartridge handle clockwise to thread back into wall fitting. **DO NOT OVERTIGHTEN!**

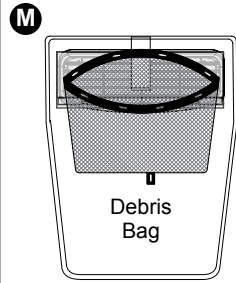

Install clean debris bag back onto the filter cover clips as shown (you can flip the filter skimmer and use the back side to extend usage).



Reinstall the skimmer shield over the filters. Then turn power to spa back on.

15.2 Draining and Refilling

About every 3 to 6 months, you will want to replace the spa's water. The frequency depends on a number of variables including the amount of use, number of users, attention paid to water quality maintenance, etc. You will know it is time for a change when you cannot control sudsing and/or you can no longer get the normal feel or sparkle to the water even though the key water balance measurements are all within the proper parameters.

CAUTION! READ THIS BEFORE DRAINING: To prevent damage to the spas components, turn off power to the spa at the circuit breaker before draining it. Do not turn the power back on until your spa has been refilled.

CAUTION: There are certain precautions to keep in mind when draining your spa. If it is extremely cold, and the spa is outdoors, freezing could occur in the lines or the equipment (see "WINTERIZING," page 81). On the other hand, if it is hot outdoors, do not leave the spa's surface exposed to direct sunlight.

A. To drain your spa, perform the following steps (standard drain):

1. Turn off power to spa at breaker.
2. Locate the drain valve located on the front left corner on the black plastic pan. Hold the larger (rear) drain valve body to prevent it from turning, then loosen and remove the front cap to expose the underlying male hose threads.
3. Attach a garden hose to the exposed threads.
4. Gently rotate the larger (rear) valve body 1/3 turn counterclockwise to unlock the drain valve.
5. Pull the larger (rear) body outward as shown to open drain.
6. After the spa drains, perform steps 2-5 in reverse order to close the drain prior to refilling spa.

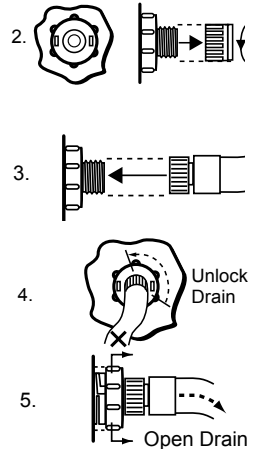

After refilling, turn on power to the spa and follow the steps listed under "Spa Fill Up Procedures" (page 18). Always fill your spa through both filter buckets.

B. To drain your spa, perform the following steps (QuickDrain):

1. Turn off power to spa at breaker.
2. Locate the QuickDrain valve on the left side of the black plastic pan (Figure A).
3. Unscrew drain valve cap to expose the underlying female threads (Figure B). Place the cap aside.
4. Screw in the adapter with hose that was included in the equipment bay (Figure C). Make sure to direct the hose to an area where the water will drain properly.
5. Once you begin to install the QuickDrain adapter (Figure D) it will push in the valve and the spa will start draining.
6. After the hot tub has drained, unscrew the QuickDrain adapter. Reinstall the QuickDrain cap before refilling hot tub.

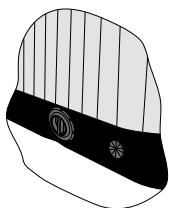

Figure A

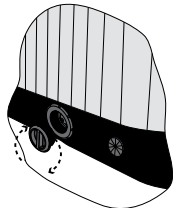

Figure B

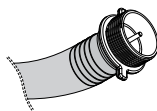

Figure C

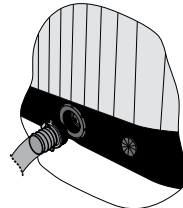

Figure D

After refilling, turn on power to the spa and follow the steps listed under "Spa Fill Up Procedures" (page 18). Always fill your spa through both filter buckets.

Note: If the pumps surge, please check the QuickDrain cap to make sure it is tighten and correctly installed.

15.3 Cleaning the Spa Interior

To preserve the sheen of your spa's surface, it is crucial that you avoid using abrasive cleaners or cleaners which have adverse chemical effect on the surface. If you are not certain as to the suitability of a particular cleanser, consult your authorized Jacuzzi dealer. Regardless of the cleanser used, use extreme care to assure that no soap residue is left on the surface. This could cause severe sudsing when the spa is refilled.

15.4 Pillow Care

Clean the headrests in your spa as needed by wiping them with a cloth with soapy water. It is not necessary to remove the headrests for cleaning. To remove headrests for long term storage or replacement, grasp both ends of each headrest and gently pull inward towards the center of the spa. To reinstall, over mounting strip and press down until headrest mounting bracket emits a "click" sound. Then adjust headrest height by simply moving up or down as desired.

15.5 Maintaining the Synthetic Cabinet

The synthetic cabinet requires little or no maintenance of any kind. To clean, simply wipe cabinet with mild detergent soap solution and a clean towel.

15.6 Cleaning the Control Panel

To clean, simply wipe cabinet with a micro-fiber cloth that is used for cleaning polycarbonate lenses.



CAUTION: Never spray cabinet with a high pressure garden hose for any reason since this action may induce an electrical short in the spa's electrical equipment.

15.7 Vinyl Cover Care and Maintenance

Your Jacuzzi cover has a vinyl encasement. This vinyl encasement is attractive and durable. Monthly cleaning and conditioning is strongly recommended to maintain and increase the longevity of your cover.

A. To Clean and Condition the Vinyl Cover

1. Use a garden hose to loosen debris and dirt.
2. Using a large sponge or a soft bristle brush, use diluted or mild soap and scrub the vinyl top. Rinse clean and do not allow soap to dry on cover. Do not use soap on the underside of the cover.
3. Please check with your Jacuzzi Dealer for recommended cover care and conditioning products. Condition using non-petroleum based conditioners to keep the vinyl supple and threads/stitching from drying out. Do not use solvents, abrasive cleaners or strong detergents. Do not use products that contain silicone or alcohol.

B. Additional Care and Maintenance Instructions:

1. Debris can accumulate on the spa cover. Removal of snow or other debris will help to avoid breakage of the foam cores.
2. Be sure to lock the cover straps to secure the cover from unwanted or accidental entry.
3. Do not place heavy objects on the vinyl.
4. Do not walk, sit or stand on the cover.
5. Do not drag or use the flaps/skirt or the cover lock straps to remove the cover.
6. Use only recommended cover lift systems.
7. Use only chemicals and cleaners recommended by Jacuzzi.
8. Remember to keep spa covered when not in use. Maintaining proper water levels assures efficient operation and efficient electrical usage.
9. Do not expose your spa to the sun for extended periods of time as UV rays can damage the interior surface.
10. Use caution when removing cover. Before removing cover, assure all locks have been released to avoid lock breakage and or cover strap damage.

15.8 Winterizing

Your Jacuzzi spa is designed to automatically protect itself against freezing when operating properly. During periods of severe freezing temperatures, you should check periodically to be certain that the electrical supply to the spa has not been interrupted. Constantly check the indicator light to make sure it is white, page 60. In extreme, bitter cold weather (less than -20°F) we recommend that the circulation pump is set for 24-Hour operation (Section 13.1 Programming The Primary Filter Cycle, page 68) and that auto-heating is selected (Section 12.2 Auto-Heating, page 62) to protect against damage to the spa.

If you do not intend to use your spa, or if there is a prolonged power outage during periods of severe freezing temperatures, **it is important that all water be removed from the spa and equipment to protect against damage from freezing.**

Expert winterization of your spa is highly recommended, contact your authorized Jacuzzi dealer. In emergency situations, damage can be minimized by taking the following steps:

CAUTION: TURN OFF POWER TO SPA.

1. Follow the directions on page 78 for draining the spa.
2. Turn the massage/diverter selector(s) into the middle combo position to allow the water in the plumbing lines to drain, see page 60.
3. Turn the waterfall valve to the open position to allow the water in the plumbing lines to drain, see page 59.
4. As the water level drops below the seats, use whatever means necessary to get the water out of the recessed seating areas and into the footwell, such as a wet/dry vacuum.
5. Open all the air controls and leave them open until you resume use of the spa, page 59.
6. When the water level ceases to drop, use whatever means available to remove any remaining water from the footwell, such as a wet/dry vacuum.
7. Remove the equipment-side cabinet panels and locate the drain plugs in the front of each pump (Figure A, page 12). Remove these plugs to allow the water to drain out of the pumps and heater.

Note: Approximately one to two gallons will be released during this procedure. Use a wet/dry vacuum or other means to keep this from flooding the equipment compartment. Replace the drain plugs.

8. Loosen hose clamp at bottom of heater (Figure A, page 12) and pull hose off of heater fitting (twist the hose back and forth while pulling downward). Tip hose down and allow to drain, then reinstall hose and clamp.
9. Loosen the hose clamp on the circulation pump (if equipped) intake behind the control box (Figure A) and pull the hose off (twist hose back and forth while pulling outward). Tip hose down and allow to drain, then reinstall hose and clamp.

10. Loosen hose clamp at bottom of CLEARRAY® system and pull hose off of CLEARRAY fitting (twist the hose back and forth while pulling downward). Tip hose down and allow to drain. Then reinstall hose and clamp. Remove the cover of the CLEARRAY system to access the UV bulb and quartz tube. Remove and store the UV bulb in a safe location. Remove and dry off the quartz tube then reinstall it. Depending on the length of time, consider replacing the UV bulb when you resume use of your hot tub.
11. Re-install cabinet side panels and cover spa so that no casual moisture can enter into it.

Consult your Jacuzzi dealer if you have any questions regarding winter use or winterizing.

15.9 Restarting Your Spa in Cold Weather

If you want to start up your spa after it has sat empty for a time in freezing temperatures, be aware that the water remaining in certain sections of the piping may still be frozen. This situation will block water flow preventing the spa from operating properly and possibly damaging the equipment. We recommend you consult your dealer for guidance before attempting to restart your spa under these conditions.

16.0 Water Quality Maintenance

To decrease the risk of contracting a waterborne illness (e.g. an infection, bacteria or virus) and/or respiratory ailments, maintain water quality within specified limits. This will enhance your enjoyment and prolong the life of the hot tub's equipment. Doing so requires regular attention because the water chemistry involved is a balance of several factors. Procrastination in regard to water maintenance will result in poor and potentially unhealthful conditions for soaking and even damage to your hot tub investment. For specific guidance on maintaining water quality, consult your authorized Jacuzzi dealer who can recommend appropriate chemical products for sanitizing and maintaining your hot tub.



WARNING: FAILURE TO MAINTAIN WATER QUALITY WILL:

- Increase risk of contracting a waterborne illness (e.g. an infection bacteria or virus) and/or respiratory ailments.
- Damage the equipment, components and spa shell, which are not covered under the hot tub's warranty.

CAUTION: Never store hot tub chemicals inside the hot tub's equipment bay. The equipment bay may reach elevated temperatures, this is where high voltage electronic devices are located. This area is not intended for storage of any kind.

16.1 pH Control

pH is a measure of relative acidity or alkalinity of water and is measured on a scale of 0 to 14. The midpoint of 7 is said to be neutral, above which is alkaline and below which is acidic. In spa water, it is very important to maintain a slightly alkaline condition of 7.4 to 7.6. Problems become proportionately severe the further outside of this range the water gets. A low pH will be corrosive to metals in the spa equipment. A high pH will cause minerals to deposit on the interior surface (scaling). In addition, the ability of the sanitation agents to keep the spa clean is severely affected as the pH moves beyond the ideal range. That is why almost all spa water test kits contain a measure for pH as well as sanitizer.

16.2 Sanitizing

To destroy bacteria and organic compounds in the spa water, a sanitizer must be used regularly. Chlorine and bromine are the two most popular sanitizers used to date. The "Proclear Mineral Spa Clarifier" designed especially for your hot tub is a beneficial product for water maintenance. Many other additives are available for your spa. Some are necessary to compensate for out-of-balance water; some aid in cosmetic water treatment and others simply alter the feel or smell of the water. Your authorized Jacuzzi dealer can advise you on the use of these additives. When adding spa shock (chlorine or non-chlorine) or pH balancing chemicals activate the jet pump(s) and leave the spa cover open for a minimum of 20 minutes. By doing this you will allow excessive chemical vapors to exit the spa, protecting pillows and plastic knobs from chemical attack.



WARNING: RISK OF PERSONAL INJURY, DROWNING OR ENTRAPMENT!

Never leave your hot tub unattended for any reason while the cover is open and accessible, especially to small children and animals!

CAUTION: RISK OF PERSONAL INJURY OR SPA DAMAGE!

Never add chlorine tablets (trichlor) or acid to your hot tub for any reason! These chemicals may damage components within your hot tub, burn or irritate your skin, create a rash and void the manufacturer warranty for your spa.

16.3 Other Additives

Many other additives are available for your spa. Some are necessary to compensate for out-of-balance water, some aid in cosmetic water treatment and others simply alter the feel or smell of the water. Your authorized Jacuzzi dealer can advise you on the use of these additives.

16.4 CLEARRAY® (Ultraviolet) Water Purification System

CLEARRAY Water Purification System is exclusive technology utilizing natural ultraviolet technology to eliminate waterborne bacteria, viruses, and algae in portable spas. The ultraviolet light otherwise known as UV-C or germicidal light inactivates the microorganisms disrupting the DNA so that it cannot reproduce and is considered lifeless. CLEARRAY is plumbed in-line with your filtration system. After the water is drawn from the pump, filter, and heater it is then directed through the CLEARRAY system. Water passes through an ultraviolet light energy that treats and disinfects the water. The water is then pumped back into the spa giving you crystal clear water instantly. The system has a ballast that is the power supply for the purification system; it has two LED indicator lights the green indicating incoming power flow and the red indicating the system is properly working. CLEARRAY is standard for all models.

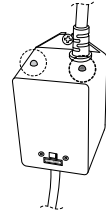
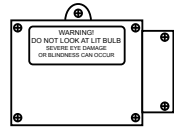

Note: The CLEARRAY System only runs when the circulation pump is running and shuts off when either jets pump is manually activated during spa use. The system will remain off for 5 minutes after both jets pumps time out or are manually turned off, then resume operations if the circulation pump is programmed to run.

After a year the bulb must be replaced. If the UV timer has been programmed correctly a message will appear on the LED display when the time allotted has expired. In order to clear the "blb" message a new UV bulb needs to be installed and the timer must be reset (Section 12.5, page 66).

16.5 CLEARRAY® Bulb Replacement and Quartz Tube Maintenance

Important: It is **MANDATORY** that the UV bulb is replaced and the quartz tube be cleaned every 12 months to maintain optimum performance.

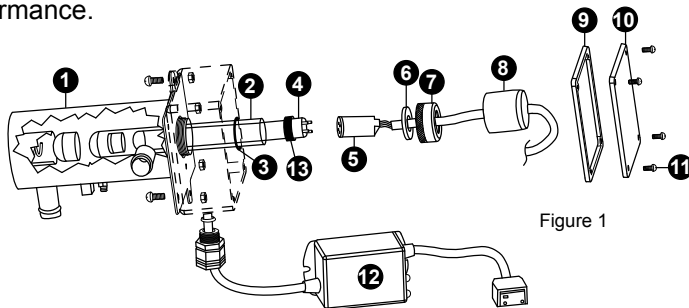

Figure 1



DANGER: TURN THE SPA BREAKER TO THE OFF POSITION!



WARNING: DRAIN THE SPA IF YOU ARE REPLACING OR CLEANING THE QUARTZ TUBE!



WARNING: ALLOW BULB TO COOL DOWN PRIOR TO REMOVING FROM QUARTZ TUBE.



DANGER: NEVER LOOK AT THE LIT BULB. THIS CAN CAUSE SEVERE EYE DAMAGE OR BLINDNESS.

UV bulb replacement and quartz tube maintenance:

Note: Location of CLEARRAY System and connection may vary by model.

1. Turn the breaker to the spa OFF. DRAIN YOUR SPA. Disconnect the CLEARRAY System from the controller, Figure 2.

Note: If you are only replacing the UV bulb then the spa does not have to be drained. You will need to drain it if you are replacing or cleaning the quartz tube.

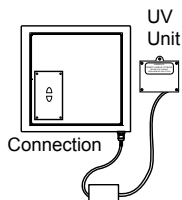

Figure 2



DANGER: NEVER REMOVE COVER WITHOUT FIRST TURNING OFF AT POWER SOURCE AND DRAINING THE SPA.

2. Once the UV bulb has cooled off remove the CLEARRAY System enclosure cover (10) and gasket (9) by removing the four screws (11).

Figure 3

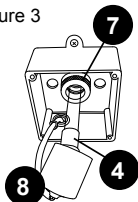

Figure 4

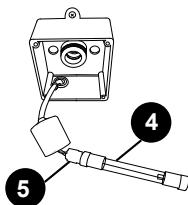
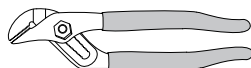

Figure 5



3. Remove the black bulb boot (8) by sliding it over the cable away from the quartz seal compression nut (7), Figure 3.
4. Slowly remove the UV bulb (4) out of the quartz tube.
5. Remove bulb socket (5) from the UV bulb (4), Figure 4.
6. Remove the quartz seal compression nut (7) by turning it **counterclockwise**, Figure 3. Use a pair of channel-lock pliers if needed, Figure 5. You will notice that there is a stainless steel compression washer (6) that slides over the quartz tube. Save the washer (6) for later use, Figure 6. There is also a black seal ring (13), grasp the black seal ring; slowly and carefully remove the quartz tube.

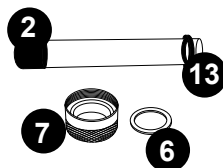

Figure 6

7. Now you are ready to clean or replace the quartz tube (2). For the cleaning of the quartz tube (2), follow steps 8 and 9 then proceed to step 10. For replacing of the quartz tube (2), skip steps 8 and 9 and proceed to step 10.
8. **Cleaning quartz tube:** Clean the quartz tube by wiping until clear using a paper towel or a dry cotton cloth. If needed a household tub and shower lime removal product can be used.



WARNING: Do not use abrasive cleaners as they can scratch the quartz tube surface.

9. Rinse the quartz tube with clean water to completely remove any cleaning products that were used in step 4.
 10. **Replacing quartz tube:** You will notice that the new quartz tube does not have a black cushion on the domed end as the old quartz tube does. This is normal as the cushion was provided with the original quartz tube to protect it from breakage during transportation. Install the black seal ring (13) over the opened end of the quartz tube. Place the new quartz tube (2) into the water chamber (1) with the domed end first making sure it is inserted and seated inside the quartz end holder. Only a small portion will be exposed when it is seated correctly.
 11. Reinstall the compression washer (6) over the open end of the quartz tube (2). Push it against the quartz black seal ring (13).
 12. Reinstall and hand tighten the quartz seal compression nut (7) by turning it **clockwise**.
 13. Refill your spa.
 14. **System Test 1:** Assure there is no water dripping from the seal compression nut (7). If water is visible, STOP and tighten the compression nut (7) using a pair of channel lock pliers to a maximum of 1/4 turn. If that does not fix the leak, then repeat quartz tube maintenance process from step 1 through step 13. Make sure there is no water leaking before proceeding to step 15.
 15. **System Test 2:** Reconnect the CLEARRAY System to the controller. Turn breaker back ON and turn on the pump to circulate the water through the CLEARRAY System. Wait for 5 minutes and assure no water is dripping. If water is visible, STOP, fix the leak by repeating quartz tube maintenance process from step 1 through step 14. **Make sure there is no water visible. Turn the pump and breaker OFF, and disconnect the CLEARRAY System from the controller BEFORE proceeding to step 16.**
 16. Reconnect the bulb socket (5) to the new UV bulb (4) make sure you use the latex glove provided when handling the UV bulb.
- Note:** Align pins on UV bulb (4) to the receptacle holes on the bulb socket (5) before inserting the pins completely into socket holes. Failure to do so will damage the UV bulb.



WARNING: DO NOT TOUCH THE NEW UV BULB WITH YOUR BARE HAND. Oil on your skin will cause hot spot on the UV bulb and shorten the life of your UV bulb. Use the provided latex glove to handle the UV bulb.

17. Slide the new UV bulb (4) back inside the quartz tube, Figure 3.
18. Reinstall the black bulb boot (8) back over the quartz seal compression nut (7).
19. Reinstall the enclosure cover (10) with gasket (9) and secure with the screws.
20. Reconnect the CLEARRAY System to the controller and turn on the power to the spa.
21. Properly dispose of the old UV bulb.



WARNING: This CLEARRAY System includes a UV bulb, which contains mercury. Dispose of the bulb in accordance with disposal laws. See www.lamprecycle.org.

22. Once power is activated you can check the ballast (12), Figure 7, to see if the CLEARRAY System is functioning. A solid green light indicates that the CLEARRAY System is being provided power and should always be on. A solid red light indicates that UV bulb is activated.

Indicator
Lights



Figure 7

17.0 Error/Display Messages



There are a number of unique functions designed into your Jacuzzi spa to protect it from damage and/or to aid in troubleshooting. When an error occurs the spa will notify you by showing the screen below and an error code next to it. Also the indicator light located on the front cabinet panel of the spa is an early detection system that will notify you when the spa needs immediate attention. A solid white light indicates that all operations are normal. A solid red light indicates that immediate attention is required to clear or fix an error code. Following is a listing of all the possible messages along with their meanings. **Always insist on genuine Jacuzzi replacement parts.**

Error	Logo Light	Error	Logo Light
Overheat Protection	Red	Shorted Sensor (Hi-Limit)	Red
Water is below set-temp	White	Start-up Malfunction	Red
Communication Error	Red	Open Flow Switch	Red
Pump does not operate	Red	Closed Flow Switch	Red
Freeze Protection	White	Audio Comm. Malfunction	White
Emergency Shutdown	Red	Blinking Heater Icon	White
Open Sensor	Red	Extended Temp Activated	White
Shorted Sensor	Red	Please Check Filter	White
Open Sensor (Hi-Limit)	Red	Feature Not Installed	White

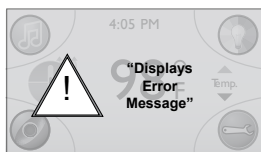

1. Overheat protection: (Heater is deactivated, filter/circulation pump is activated). Water temperature is above acceptable limits. **DO NOT ENTER THE WATER!** Remove spa cover to speed cooling. See "Water Is Too Hot" on page 93. If condition persists, contact your authorized dealer or authorized service center.



WARNING: RISK OF HYPERTHERMIA (OVER-HEATING) CAUSING SEVERE INJURY, BURNS, OR WELTS.

2. Water is below set-temp: If the spa water is more than 20°F/6°C cooler than the temperature set point, the circulation pump and heater will automatically activate to provide freeze protection. The spa will stay in this mode until the water temperature reaches 15 degrees below the set temperature. No corrective action is necessary.

3. Communication error: Communication between the control panel and circuit board is faulty. If condition persists, contact your authorized dealer or service organization.
4. Pump does not operate: Proper flow of water is inhibited or a flow switch has malfunctioned. Check for proper water level and for clogged filter (page 74). If no sound is detected or if a “buzzing” sound is detected, turn off power to the hot tub. Pump may not be properly primed. If condition persists, contact your authorized dealer or service organization.
5. Freeze protection: A potential freeze condition has been detected. No action is required. Jets pump(s) and heater operate until the spa is out of danger. Depending on the amperage provided, operation will be as follows:
 - In 60A or 20A (50Hz only) logic, the heater remains on at all times, while pump 1 and pump 2 turn on for 10 minutes and then off for 10 minutes. The pumps will alternate on and off until the spa gets out of the freeze condition.
 - In 50A or 30A logic, the heater turns on for 10 minutes then turns off. Then pump 1 and pump 2 turn on for 10 minutes, then turn off. The spa will alternate between the heater and the pumps being on and off until the spa gets out of the freeze condition.

Note: The pumps cannot be manually controlled while the Freeze condition is active. If a button is pushed, the error message will go away, but will reappear if the spa is still in the Freeze condition 5 minutes later. This error commonly occurs when the spa is first filled because tap water is often very cold.

6. Emergency shutdown: Water temperature is above acceptable limits. **DO NOT ENTER SPA!** (spa is deactivated) A problem has been detected which could cause damage to the spa or its components. Contact your authorized dealer or service organization.



WARNING: RISK OF HYPERTHERMIA (OVER-HEATING) CAUSING SEVERE INJURY, BURNS, OR WELTS.

7. Open sensor: The temperature sensor is not functional. Heater is disabled. This must be repaired only by a qualified authorized service organization or service technician.
8. Shorted sensor: The temperature sensor is not functional. Heater is disabled. This must be repaired only by a qualified authorized service organization or service technician.
9. Open sensor: The hi-limit temperature sensor is not functional. Heater is disabled. This must be repaired only by a qualified authorized service organization or service technician.

10. Shorted sensor: The hi-limit temperature sensor is not functional. Heater is disabled. This must be repaired only by a qualified authorized service organization or service technician.
11. Start-up malfunction: Flow switch is non-functional. Closed or shorted flow switch on system start-up (system disabled). This must be repaired only by an authorized dealer or qualified service organization.
12. Open Flow Switch: (Heater is deactivated. The filter/circulation may also be deactivated.) The flow switch is malfunctioning open, the circulation pump's filter cartridge is excessively dirty, or an air lock condition has occurred at the circulation pump intake. Contact your authorized dealer or service organization.
13. Closed Flow Switch: (Heater is deactivated. The filter/circulation may also be deactivated.) The flow switch is malfunctioning closed. Contact your authorized dealer or service organization.
14. Audio Communication Malfunction: Communication between the control panel and audio system is faulty. Shutdown power to the spa, wait 3 seconds and restart the spa to reset the communication. Contact your authorized dealer or service organization.
15. Blinking Heater icon: This icon will blink on and off to indicate that:
 - The temperature sensor is sensing a $-20^{\circ}\text{F}/6^{\circ}\text{C}$ difference between the actual and set temperature or;
 - The temperature sensor is sensing a temperature above $112^{\circ}\text{F}/44^{\circ}\text{C}$ or the hi-limit temperature sensor is sensing a temperature above $116^{\circ}\text{F}/46^{\circ}\text{C}$.



16. Extended Temperature Activated:

The spa is set to go up to 104°F (40°C), but it can be set to reach 106°F (41°C). To access the extended temperature you must press the "Up" (on the Quad Keypad) button and button D at the

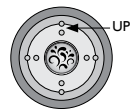
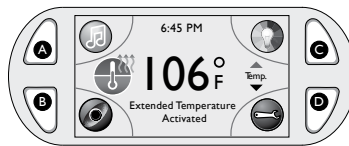

Figure A

same time for 2 seconds. The system will now allow you to raise the temperature to 106°F (41°C) and the LCD display will read **"EXTENDED TEMPERATURE ACTIVATED"** (Figure A). To clear this message, just press the Down button on the Quad Keypad to lower the temperature below or back to 104°F (40°C).

17. Please Check Filter!

This message will appear when the filter reminder time has expired (Figure B). Please remove the ProClarity/Proclear filters and filter/debris bag for cleaning or replacement.



Figure B

18. Feature not installed:

This message will appear when a user tries to activate a feature that is not installed. To clear the message press button D to return to the Main Menu.

19. Clear Settings 2 Programs:

This message will appear when you choose to reset all settings 2 menu settings back to factory defaults (Figure C). You can either press the Splash button to reset or press the Previous button D to cancel.

Figure C

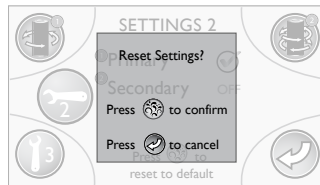
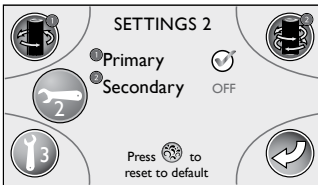

20. Remote bonding screens:

These message screens will appear when the wireless remote has been bonded to the spa and can now be used to control the spa functions (Figure D).

Figure D

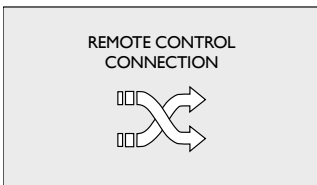

18.0 Troubleshooting Procedures

In the unlikely event your spa is not working the way you believe it should, please first review all the installation and operating instructions in this manual and check the message on the panel display; second, if you are still not satisfied it is working properly, please follow the appropriate troubleshooting instructions.

PROBLEM

PROCEDURE

NONE OF THE COMPONENTS OPERATE (i.e. pump light)

Check the control panel lights.

1. If there are letters or symbols displayed on the screen, refer to the previous section to determine the meaning and action required.
2. If nothing appears on the screen:
 - A. Check the household circuit breaker.
 - B. Contact you dealer or authorized service center.

PUMP DOES NOT OPERATE AND ICON DOES

Activate the "JETS":

1. If no sound is detected or if a "buzzing" sound is detected, turn off power to the spa and contact your dealer or service center.
2. If motor operates but no water flows to jets:
 - A. Pump may not be properly primed. See instructions below.
 - B. Contact dealer or authorized service center.

Pump Priming Instructions:

1. Turn off power to the spa.
2. Remove the handle from the massage selector supplied by the pump you are priming.
3. Loosen the massage selector's cap slightly (counterclockwise), listening for the air to seep out.
4. Tighten the cap finger-tight, replace the handle and turn the hot tub's power back on.

Note: This method must be used for the jet's pumps because these pumps are not connected to the main filter system in any way.

CAUTION: If freezing conditions exist and pump is not operational, take measures to protect the system from freeze damage. See Section titled "Winterizing" (page 81).

POOR JET ACTION
(see pages 23-40)

1. Make certain the jets pump is turned on.
2. Check position of massage selectors.
3. Open air control for selected jet system.
4. Check for adequate water level.
5. Check for dirty filter (page 74).

WATER IS TOO HOT

1. Reduce thermostat setting (page 19).
2. Switch hot tub to “Programmable” mode to turn heater on only during programmed filter cycles (page 63).

NO HEAT

1. Check thermostat setting.
2. Keep the cover in place while heating.
3. If heater indicator is displayed, but no temperature increase is experienced after a reasonable period of time, contact your dealer or authorized service center.

**FILTER/CIRCULATION
PUMP OFF**

1. Verify filter/circulation pump is programmed to run 12 hours a day (page 68).
2. Filter/circulation pump cycle canceled by power interruption. Wait 24 hours for hot tub to reset.
3. Hot tub water is warmer than 95°F (34°C) and two degrees warmer than the set temperature. The “Summer Logic” safety feature has activated. See note on page 68 for details.

Jacuzzi builds the best spas in the industry. Nonetheless, we are always striving to improve the quality and features of our products. Your input as a Jacuzzi spa owner is a cherished part of this process. If you have any comments or suggestions, or if you wish to be informed on any new products for your spa, please write to us.

CONGRATULATIONS on your good taste and welcome to the happiest and most relaxed family in the world!

19.0 Typical Spa Wiring Diagrams

19.1 Wiring diagram for North American 60 Hz Models Only

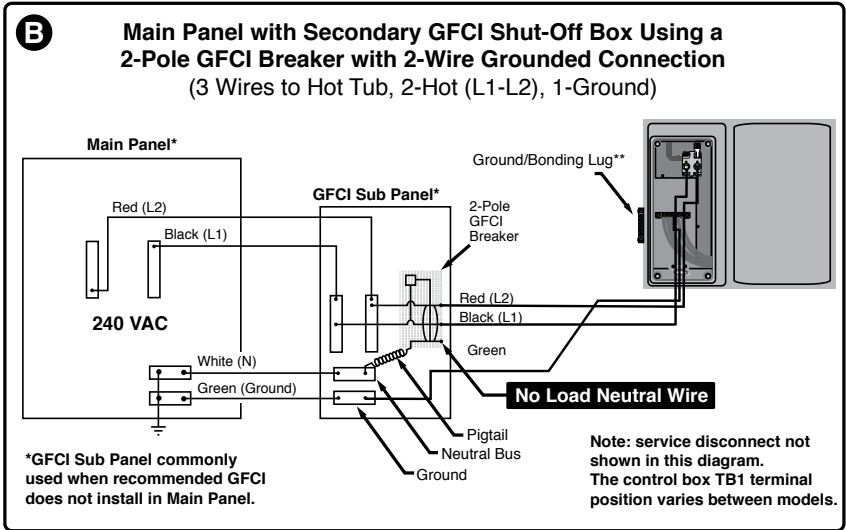
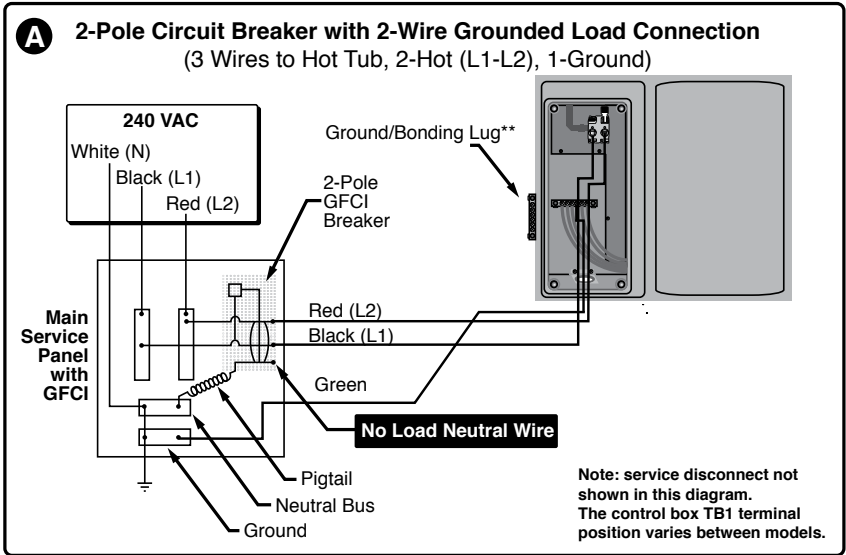

20.0 Optional Jacuzzi J-1000™ Audio System Stereo

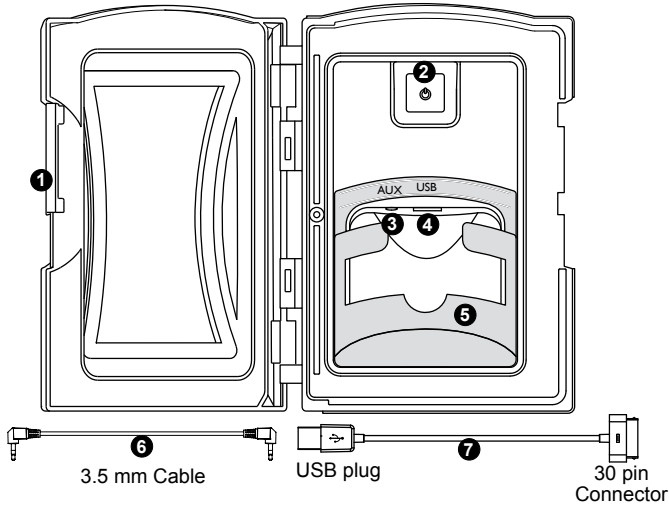

1. **Media Locker Handle**
Slide the handle to lock and unlock the protective door.
2. **Power Button**
Press power button once to turn “ON” stereo system. Press a second time to place the stereo in standby mode and the red light will remain illuminated.
3. **Auxiliary Input Jack Connector**
Allows you to connect an Auxiliary device by using a 3.5 mm cable. Refer to page 47 for operating instructions.
4. **Universal Serial Bus (USB) Device Connector**
Allows you to connect your device via the USB port and a USB cable compatible with your device. Apple 30-pin cable supplied with the J1000 Audio System. Refer to page 48 for operating instructions.
5. **Auxiliary Device Holding Base**
The removable base securely holds the auxiliary device in place. It can be removed for larger devices.
6. **3.5 mm Plug Cable**
Use this cable to connect your Auxiliary or MP3 device to the stereo via the “AUX” connection.
7. **Apple 30-pin to USB Cable**
Use this cable to connect your compatible iPod, iPhone or MP3 device to the stereo via the “USB” port.

Note: Digital Rights Management (DRM) Files cannot be played on this deck. Personal files (MP3, WMA, iTunes or AAC) can be played as long as they are not DRM encrypted.



WARNING: RISK OF ELECTRICAL SHOCK HAZARD EXISTS AND EQUIPMENT DAMAGE! Never install or remove electrical devices while hands are wet or while sitting partially immersed or fully immersed in spa!

CAUTION: Never leave electrical devices in the Docking Station when spa is not in use to prevent damage from outdoor elements! Never spray Docking Station with a pressurized water hose for any reason! Damage to the device or spa stereo system caused by water intrusion is not covered under the manufacturer's warranty! Damage to Docking Station port or electrical devices due to excessive force or improper alignment during installation or removal from Docking Station is not covered under warranty.

20.1 Optional J-1000 Wireless Remote

A. The Optional J-1000 Remote (Included with models equipped with the Audio System)

Most spa functions can be controlled with the remote (Figure A). The sleek modern design and easy navigation make this remote a great addition to your spa enjoyment. Listed below are the remote features, how to access and control them. General features of the remote are:

- The remote does not have a touch screen.
- When you first use the remote, it needs to be bonded to the spa.
- When not in used or after any 15 seconds of inactivity the remote goes into a "Sleep" status until activated. The backlighting and display will turn off.
- When activated the remote checks and verifies that it and the control system are bonded.
- When activated the remote checks to see if any of the components are running. If so, the component icon will blink on the remote LCD display to alert you that those components are activated. The water temperature is displayed on top of the screen, while the main menu is displayed.
- Pressing any key will activate the remote; the backlight will turn on and illuminate the keys and display. This lighting has a 10 second time-out period if no keys are pressed.

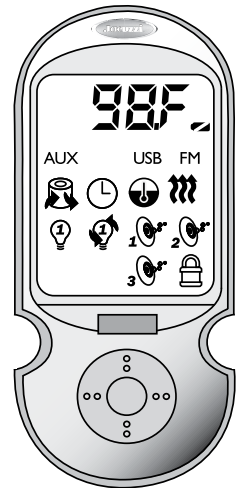

Figure A

Note: Remote unit is **water resistant not waterproof**, therefore the unit should never be left in the spa while the cover is on and spa is not in use. Displays for the remote will vary depending on the hot tub model.



= **Filter Boost Icon:** Allows you to active the Filter Boost feature. Jets pumps will activate for 20 minutes.



= **Time Icon:** Allows you to view the time, either in a 12-Hour or 24-Hour period.



= **Temperature Icon:** Allows you to set and control the temperature.



= **Heating Icon:** Will only appear if the spa is heating.



= **Lights 1 Icon:** Allows you to control the interior lights.



= **Show 1 Icon:** Allows you to control the interior Light Rotation mode.



= **Jet 1 Icon:** Allows you to turn on/off the jets pump 1.



= **Jet 2 Icon:** Allows you to turn on/off the jets pump 2.



= **Jet 3 Icon:** Allows you to turn on/off the jets pump 3.



= **Lock Icon:** Will only appear if the spa is in locked mode and needs to be unlocked via the spa not the remote.



= **Low Battery Icon:** Notifies you when the batteries are low and might need to be replaced. This icon will only appear if the battery is low.



= **Return button:** Will return you to the Main menu from most submenus.

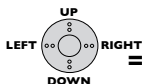

= **Navigational Keypad:** Allows you to make selections using the Up, Down, Left, and Right buttons. The Select button is in the middle.



For spas with the stereo option the features below are also included.

FM = **FM Icon:** Allows access to the 18 preset stations.

USB = **USB Icon:** Allows you to access files on a USB drive. Devices must be connected in order for the remote to operate some functions.

- AUX = **AUX Icon:** Allows you to access files on an auxiliary device. Devices must be connected in order for the remote to operate some functions.

- BT = **Bluetooth Icon:** Allows you to access files on a Bluetooth device. This icon will only appear if a Bluetooth device is connected.



Remote display for spas with the stereo option



Remote display for spas without the stereo option

1. Bonding the remote and spa

When you first use the remote, it will need to be bonded to the spa for operational use. To bond the remote:

- Press button D and the Down button, at the same time, for 2 seconds (Figure B).
- The programming instructions will appear on the control panel LCD Display (Figure B).
- You will need to press the keys below on the remote unit, not the control panel on the spa, in the following sequence (Figure C):
 1. Return, up
 2. Return, up
 3. Return, up
 4. Select
- After you press the Select button, Figure D will appear on the control panel LCD Display.
- Finally, Figure E will appear once the bonding has finished. To clear the LCD display, press any key on the control panel.



Figure B



Figure C

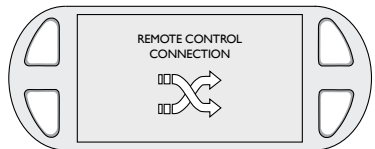

Figure D



Figure E

2. Main Menu

When any key is pressed and the remote awakes it will display the icons that are selectable. You can use the Navigational Keypad (up, down, left or right) to navigate through the screens and make selections. By moving through the icons, they will blink to let you know that if you hit the Select button you will activate that component or aspects of it.

3. Adjusting the Temperature

When the temperature icon is selected, all other icons on the display screen will disappear. The only two items shown are the thermometer icon and the digit temperature in °C or °F. Using the Navigational Keypad you can:

- Increase the temperature by pressing the Up button.
- Decrease the temperature by pressing the Down button.
- Use °C reading by pressing the Left button.
- Use °F reading by pressing the Right button.
- Go to the Main Menu by pressing the Return button or not pressing any keys for 4 seconds.

Note: When you first enter the screen the temperature display will be blinking. You can stop this by pressing any key.

4. Activating the Jets

When the Jets pump icon is selected, all other icons on the display screen will disappear. The only two items shown are the jets pump icon and the digit temperature in °C or °F. Using the Navigational Keypad you can:

- Turn on the Jets pump (either 1, 2, or 3) by pressing the Select button.
- Turn off the Jets pump by pressing the Select button.

5. Turning on the Interior Lights

When the Lights 1 icon is selected, all other icons on the display screen will disappear. The only two items shown are the temperature and the Light 1 icon. Using the Navigational Keypad you can:

- Press Select to turn the lights on or off.
- Increase the intensity by pressing the Up button (the lights will increase in increments of 25%, ranging from 25 to 100%).
- Decrease the intensity by pressing the Down button (the lights will decrease in increments of 25%, ranging from 25 to 100%).
- Go to the previous color by pressing the Left button.
- Go to the next color by pressing the Right button.
- Turn on or off the interior lights by pressing the Select button.
- Go to the Main Menu by pressing the Return button.

6. Turning on the Interior Light Rotation Mode

When the Show 1 icon is selected, all other icons on the display screen will disappear. The only two items shown are the temperature and the Show 1 icon. Using the Navigational Keypad you can:

- Increase the intensity by pressing the Up button.
- Decrease the intensity by pressing the Down button.
- Slow down the light show speed by pressing the Left button (the lights will decrease in speed from 3, 5, 10, 18, 33, or 60 seconds).
- Speed up the light show speed by pressing the Right button (the lights will increase in speed from 60, 33, 18, 10, 5, or 3 seconds).
- Turn on or off the interior Light Rotation mode by pressing the Select button.
- Go to the Main Menu by pressing the Return button.

7. Lock Reminder

If you press any key to activate the remote and the lock icon is the only thing showing, then the spa has been locked. You must first unlock the spa from the main control panel to be able to use the remote.

B. If your model is equipped with the J-1000 Audio System, the additional functions below are also controllable by your remote.

1. FM Radio Operation

You can scan through your FM preset stations and adjust the volume with the remote. When you are in the FM radio mode the screen will appear like Figure A; then it will change to the actual station number.

Using the Navigational Keypad you can:

- Increase the volume by pressing the Up button.
- Decrease the volume by pressing the Down button.
- Go to the previous preset station by pressing the Left button.
- Go to the next preset station by pressing the Right button.
- Go to the Main Menu by pressing the Return button.

Note: Export models will show a small superscripted number after the station number (Figure B).

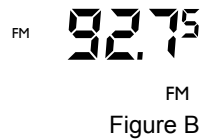
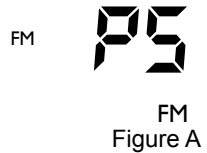

2. USB Track Operation

You can scan through the track numbers (Figure D) and adjust the volume with the remote. Once you enter the screen and the track number has appeared, the screen will change to the track duration for the track. Using the Navigational Keypad you can:

- Increase the volume by pressing the Up button.
- Decrease the volume by pressing the Down button.
- Go to the previous track by pressing the Left button.
- Go to the next track by pressing the Right button.
- Pause or play by pressing the Select button.
- Go to the Folder menu by pressing the Return button.

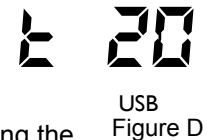

3. USB Folder Operation

You can scan through the folders (Figure C), track numbers and adjust the volume with the remote. Using the Navigational Keypad you can:

USB
Figure C

- Increase the volume by pressing the Up button.
- Decrease the volume by pressing the Down button.
- Go to the previous track by pressing the Left button.
- Go to the next track by pressing the Right button.
- Pause or play by pressing the Select button.
- Go to the Main Menu by pressing the Return button.

4. Auxiliary Operation

You can control the volume of an auxiliary device (Figure E). Using the Navigational Keypad you can:

AUX

Figure E

- Increase the volume by pressing the Up button.
- Decrease the volume by pressing the Down button.
- Go to the Main Menu by pressing the Return button.

Note: Remote control has no effect on electrical device playback if/when the generic cable output is used.



WARNING: RISK OF ELECTRICAL SHOCK HAZARD EXISTS AND EQUIPMENT DAMAGE!

Never install, handle or remove electrical devices while hands are wet or while sitting partially or fully immersed.

5. Bluetooth Operation

You can control the volume of an Bluetooth device (Figure G). Using the Navigational Keypad you can:

BT

Figure G

- Increase the volume by pressing the Up button.
- Decrease the volume by pressing the Down button.
- Go to the next track by pressing the Right button.
- Go to the previous track by pressing the Left button.
- Go to the Main Menu by pressing the Return button.

Note: The Bluetooth icon will only appear if a Bluetooth device is connected. Any other functions are controlled via the Bluetooth device.

6. Error has occurred

If the remote senses an error that needs attention, it will display the words "Spa" - "Err," one word at a time, (Figure H). The words will cycle for 1 second each. Please go to the main spa control panel for further instructions. If the user does not detect this error within 20 seconds, the remote will go to sleep mode and the backlighting will begin to flash on and off until a key is pressed.

Figure H

20.2 J-1000 Wireless Remote Battery Replacement

1. Turn the remote unit over and locate the battery door (Figure A).

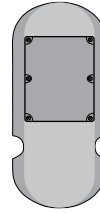

Figure A

2. Remove the six screws securing the door.

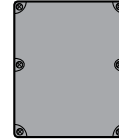

Figure B

3. Remove the battery door. You could use a small screwdriver to pry the door upward.
4. Replace or install 3 AAA batteries.

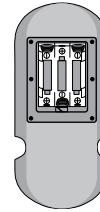

Figure C

5. Reinstall the battery door and screws.

Note: Remote unit is water resistant not waterproof. Although it is designed to be used while in the spa, it should never be left in the spa while the cover is on and spa is not in use. The remote should be stored in a dry location such as the stereo remote pouch (if applicable) located on the outside of the spa cover or within your home. Extreme weather can affect the remote control battery. In extreme hot or cold environments store the remote control indoors to prolong battery life.



20.3 J-1000 Audio System Stereo Specifications

Power supply 10.7-14.4V DC

Tuner

FM radio sensitivity 8uV
FM radio reception Stereo

20.4 Stereo Cautions

1.  **“CAUTION** - Risk of Electric Shock. Do not leave compartment door open.”
2.  **“CAUTION** - Risk of Electric Shock. Replace components only with identical components.”
3. “Do not operate the audio/video controls while inside in the spa.”
4.  **“WARNING** - Risk of Electrocution. Do not connect any auxiliary components (for example cables, additional speakers, headphones, additional audio/video components, etc.) to the system.”
5. These units are not provided with an outdoor antennae; when provided, it should be installed in accordance with Article 810 of the National Electrical Code, ANSI/NFPA 70.
6. Do not service this product yourself as opening or removing covers may expose you to dangerous voltage or other risk of injury. Refer all servicing to qualified service personnel.
7. When the power supply connections or power supply cord(s) are damaged; if water is entering the audio/video compartment or any electrical equipment compartment area; if the protective shields or barriers are showing signs of deterioration; or if there are signs of other potential damage to the unit, turn off the unit and refer servicing to a qualified service personnel.
8. This unit should be subjected to periodic routine maintenance (for example, once every 3 months) to make sure that the unit is operating properly.



