

Limelight™

HOT TUBS



Owner's Manual



Watkins Manufacturing Corporation congratulates you on your decision to enjoy the finest hot tub available... Welcome to the growing family of Limelight® hot tub owners.

Owner's Manual

This Owner's Manual will acquaint you with the operation and general maintenance of your new hot tub. We suggest that you take some time to carefully review all eleven sections. Please keep this manual available for reference.

If you have any questions about any aspect of your hot tub's set-up, operation or maintenance, contact your authorized Limelight dealership. They are trained professionals who are familiar with the product as well as new hot tub ownership concerns. Their expertise will facilitate the enjoyment of your new Limelight hot tub.

The serial number label is located within the equipment compartment of your Limelight hot tub.

IMPORTANT: Watkins Manufacturing Corporation reserves the right to change specifications, or design, without notification and without incurring any obligation.

DATE PURCHASED: _____

DATE INSTALLED: _____

DEALER: _____

ADDRESS: _____

TELEPHONE: _____

HOT TUB MODEL/SERIAL NUMBER: _____

COVER SERIAL NUMBER: _____

ACCESSORY SERIAL NUMBERS: _____



In most cities and counties, permits will be required for the installation of electrical circuits or the construction of exterior surfaces (decks and gazebos). In addition, some communities have adopted residential barrier codes which may require fencing and/or self-closing gates on the property to prevent unsupervised access to a pool (or hot tub) by children under 5 years of age. Your Limelight hot tub is equipped with a locking cover that meets the ASTM F1346-91 Standard for Safety Covers and as a result, is usually exempt from most barrier requirements. As a general practice, your local Building Department will inform you of any applicable barrier requirements at the time a permit is obtained for the installation of an electrical circuit. Your Limelight dealer can provide information on which permits may be required.

Welcome

Table of Contents

SAFETY INFORMATION

| | |
|-------------------------------------|---|
| Important Safety Instructions..... | 1 |
| Important Hot Tub Instructions..... | 3 |

HOT TUB SPECIFICATIONS.....4

INSTALLATION INSTRUCTIONS

| | |
|--------------------------------------|---|
| Site Preparation..... | 5 |
| Outdoor and Patio Installation | 5 |
| Deck Installation..... | 5 |
| Indoor Installation..... | 5 |
| Hot Tub Leveling Instructions..... | 6 |

CONTROLS AND EQUIPMENT

| | |
|-------------------------------------|---|
| Limelight® Pulse® (Model PLS) | 7 |
| Limelight Flair® (Model FLR) | 8 |
| Limelight Glow® (Model GLW) | 9 |

ELECTRICAL REQUIREMENTS AND PRECAUTIONS

| | |
|-------------------------|----|
| 230 Volt Connected..... | 10 |
|-------------------------|----|

OPERATING INSTRUCTIONS

| | |
|-------------------------------------|----|
| Start-Up and Refill Procedures..... | 12 |
| Diverter System..... | 13 |
| Air Control System..... | 13 |
| Jets | 13 |
| Water Feature | 14 |

JET SYSTEM MENU

| | |
|-----------------------------------|----|
| Limelight Pulse (Model PLS) | 15 |
| Limelight Flair (Model FLR) | 16 |
| Limelight Glow (Model GLW)..... | 17 |

CONTROL PANEL OPERATIONS

| | |
|---|----|
| Control Panel..... | 18 |
| Control Panel Buttons and Display | 18 |
| Indicator Lights..... | 19 |
| Control Panel Menu Display..... | 19 |
| Temperature Control..... | 19 |
| System Mode..... | 20 |
| Tools Menu..... | 20 |

| | |
|------------------------|----|
| Music Control | 21 |
| Display Inversion..... | 23 |

HOT TUB CARE AND MAINTENANCE

| | |
|--|----|
| Draining the Water | 23 |
| Prevention of Freezing..... | 23 |
| Filter System | 24 |
| Filter Cartridge Removal and Cleaning..... | 25 |
| Care of the Hot Tub Pillows | 25 |
| Care of the Exterior | 25 |
| ELMwood™ Hot Tub Cabinet..... | 26 |
| Care of the Hot Tub Cover..... | 26 |
| Retractable Cover Systems..... | 26 |
| Vacation Care Instructions..... | 27 |

WATER QUALITY AND MAINTENANCE

| | |
|--|----|
| General Information | 28 |
| Methods for Testing the Hot Tub Water..... | 28 |
| Limelight Hot Tub Water Maintenance Program..... | 29 |
| EverFresh® Water Care System | 31 |
| EverFresh Water Treatment Guide | 31 |
| Freshwater Ag+® Silver Ion Purifier Replacement..... | 32 |
| Chlorine (Sodium Dichlor)..... | 33 |
| Ozone (Optional Equipment)..... | 34 |
| Common Water Chemistry Questions | 36 |
| Water Terminology | 36 |

SERVICE INFORMATION

| | |
|--|----|
| GFCI and High Limit Thermostat..... | 37 |
| No-Fault® Heater and Heater Thermal Cut-off | 37 |
| Silent Flo 5000® Circulation Pump Thermal Cut-off..... | 38 |
| Freshwater® III High Output Ozone System..... | 38 |
| Miscellaneous Service Information | 38 |
| Acts Invalidating Warranty | 38 |
| Disclaimers..... | 39 |
| Watkins Customer Service | 39 |
| Troubleshooting Guides..... | 40 |

SAFETY INFORMATION

IMPORTANT SAFETY INSTRUCTIONS

(Read and follow all instructions)

AVOIDING THE RISK TO CHILDREN

DANGER:

- **RISK OF CHILD DROWNING.** Extreme caution must be exercised to prevent unauthorized access by children. To avoid accidents, ensure that children cannot use a hot tub unless they are supervised at all times.

WARNING:

- To reduce the risk of injury, do not permit children to use this hot tub unless they are closely supervised at all times.
- To reduce the risk of injury, lower water temperatures are recommended for young children. Children are especially sensitive to hot water.

DO:

- Make sure you always lock the child resistant locks after using the hot tub for your children's safety. Every Limelight® hot tub is equipped with a locking cover that meets the ASTM F1346-91 Standard for Safety Covers.
- Test the water temperature with your hand before allowing your children to enter the hot tub to be sure that it's comfortable. Children are especially sensitive to hot water.
- Remind children that wet surfaces can be very slippery. Make sure that children are careful when entering or exiting the hot tub.

DON'T:

- Allow children to climb onto the hot tub cover.
- Allow children to have unsupervised access to the hot tub.

AVOIDING THE RISK OF ELECTROCUTION

RISK OF ELECTROCUTION

- Connect only to a grounded source.
- Do not bury the power cord. A buried power cord may result in death, or serious personal injury due to electrocution if direct burial-type cable is not used, or if improper digging occurs.
- A ground terminal (pressure wire connector) is provided on the control box inside the unit to permit connection of a minimum No. 8 AWG (8.4 mm²) solid copper bonding conductor between this point and any metal equipment, metal water pipe, metal enclosures of electrical equipment, or conduit within five feet (1.5 m) of the unit as needed to comply with local requirements.
- Do not operate the audio main controls while inside the spa (if spa is equipped with an audio component).
- Do not connect any auxiliary components (for example, cable additional speakers, headphones, additional audio components) to the audio system unless approved by Watkins Manufacturing Corporation .
- Do not self service audio component by opening or removing cover as this may expose dangerous voltage or other risk of injury. Refer all servicing to qualified service personnel.
- Do not attach an external antennae to a spa audio system unless installed by a licensed electrician in accordance with Article 810 of the National Electric Code, ANSI/NFPA 70.

WARNING:

- To reduce the risk of electrical shock, replace a damaged cord immediately. Failure to do so may result in death or serious personal injury due to electrocution.

230 volt, permanently installed

- A ground terminal is provided on the terminal block (TB-1, system ground terminal) located inside the control box. To reduce the risk of electric shock, connect this terminal to the grounding terminal of your electrical service or supply panel with a continuous green, insulated copper wire. The wire must be equivalent in size to the circuit conductors supplying the equipment. In addition, a bonding terminal (pressure wire connector) is provided on the outside of the control box for bonding to local ground points. To reduce the risk of electric shock, this connector should be bonded with a No. 8 AWG (8.4 mm²) solid copper wire to any metal ladders, water pipes, or other metal within 5 feet (1.5 m) of the hot tub to comply with local requirements. The means of disconnection must be readily accessible, but must be installed at least 5 feet (1.5 m) from the hot tub.

- Your hot tub is provided with a suitably rated circuit breaker to open all ungrounded supply conductors.
- Your hot tub uses ground fault circuit interrupters in the electrical subpanel. Before each use of the hot tub and with the unit operating, push the TEST button on each breaker. The switch should click over to the "Trip" position. Wait 30 seconds and reset each GFCI breaker by switching it completely off and then completely on. The switch should then stay on. If either of the interrupters does not perform in this manner, it is an indication of an electrical malfunction and the possibility of an electric shock. Disconnect the power until the fault has been identified and corrected.

NOTE: Failure to wait 30 seconds before resetting the GFCI may cause the hot tub's Power Indicator (on the control panel) to blink. If this occurs, repeat the GFCI test procedure.

DANGER: RISK OF ELECTRICAL SHOCK

- Install at least 5 feet (1.5 m) from all metal surfaces. A hot tub may be installed within 5 feet of a metal surface if each metal surface is permanently connected by a minimum No. 8 AWG (8.4 mm²) solid copper conductor attached to the wire ground connector on the terminal box that is provided for this purpose if in accordance with National Electrical Code ANSI/NMFA70-1993.
- Do not permit any electrical appliances, such as a light, telephone, radio, or television within 5 feet (1.5 m) of a hot tub. Failure to maintain a safe distance may result in death, or serious personal injury due to electrocution if the appliance should fall into the hot tub.
- Install your hot tub in such a way that drainage is away from the electrical compartment and from all electrical components.

DO:

- Be sure your hot tub is connected to the power supply correctly - use a licensed contractor.
- Disconnect the hot tub from the power supply before draining the hot tub or servicing the electrical components.
- Test the Ground Fault Circuit Interrupter(s) before each use.
- Replace audio components only with identical components (if your spa is equipped with an audio component).
- Install your hot tub in such a way that drainage is away from the electrical compartment and from all electrical components.

DON'T:

- Use the hot tub with the equipment compartment door removed.
- Place electrical appliances within 5 feet (1.5m) of the hot tub.
- Use an extension cord to connect the hot tub to its power source. The cord may not be properly grounded and the connection is a shock hazard. An extension cord may cause a voltage drop, which will cause overheating of the jet pump motor and motor damage.
- Attempt to open the electrical control box. There are no user serviceable parts inside.

RISKS TO AVOID

DANGER: RISK OF INJURY

- To reduce the risk of injury to persons, DO NOT remove suction fittings or filter standpipe (located in the filter compartment).
- The suction fittings in the hot tub are sized to match the specific water flow created by the pump. Never replace a suction fitting with one rated less than the flow rate marked on the original suction fitting.
- There is a danger of slipping and falling. Remember that wet surfaces can be very slippery. Take care when entering or exiting the hot tub.
- Never operate hot tub if the suction fittings are broken or missing.
- People with infectious diseases should not use the hot tub.
- Keep any loose articles of clothing, long hair or hanging jewelry away from rotating jets or other moving components.

INCREASED SIDE EFFECTS OF MEDICATION

- The use of drugs, alcohol, or medication before or during hot tub use may lead to unconsciousness with the possibility of drowning.
- Persons using medications should consult a physician before using a hot tub; some medication may cause a user to become drowsy, while other medication may affect heart rate, blood pressure, and circulation.
- Persons taking medications which induce drowsiness, such as tranquilizers, antihistamines or anticoagulants should not use the hot tub.

HEALTH PROBLEMS AFFECTED BY HOT TUB USE

- Pregnant women should consult a physician before using hot tub.
- Persons suffering from obesity, or with a medical history of heart disease, low or high blood pressure, circulatory system problems, or diabetes should consult a physician before using hot tub.

UNCLEAN WATER

- Keep the water clean and sanitized with correct chemical care. The recommended levels for your Lighthouse™ hot tub are:

| | | | |
|----------------------------------|-------------|---------------------|-------------|
| - Free Available Chlorine (FAC): | 3.0-5.0 ppm | - Total Alkalinity: | 40-120 ppm |
| - Water pH: | 7.4-7.6 | - Calcium Hardness: | 100-150 ppm |

(Refer to Water Quality and Maintenance section for complete instructions.)

IMPORTANT: Turn on the jet pump for a least ten minutes after adding ANY hot tub water chemicals into the filter compartment.

- Clean the filter cartridge monthly to remove debris and mineral buildup which may affect the performance of the hydromassage jets, limit the flow, or trip the high limit thermostat which will turn off the entire hot tub.

AVOIDING THE RISK OF HYPERTHERMIA

Prolonged immersion in hot water can result in HYPERTHERMIA, a dangerous condition which occurs when the internal temperature of the body reaches a level above normal (98.6°F). The symptoms of hyperthermia include unawareness of impending hazard, failure to perceive heat, failure to recognize the need to exit the hot tub, physical inability to exit the hot tub, fetal damage in pregnant women, and unconsciousness resulting in a danger of drowning.

⚠ WARNING:

The use of alcohol, drugs, or medication can greatly increase the risk of fatal hyperthermia in hot tubs.

TO REDUCE THE RISK OF INJURY:

- The water in the hot tub should never exceed 104°F. Water temperatures between 100°F and 104°F are considered safe for a healthy adult. Lower water temperatures are recommended for extended use (exceeding ten minutes) and for young children. Extended use can cause hyperthermia.
- Pregnant or possibly pregnant women should limit hot tub water temperatures to 100°F. Failure to do so may result in permanent injury to your baby.
- Do not use hot tub immediately following strenuous exercise.

AVOIDING THE RISK OF SKIN BURNS:

- To reduce the risk of injury, before entering a hot tub the user should measure the water temperature since the tolerance of temperature-regulating devices may vary.
- Test the water with your hand before entering the hot tub to be sure it's comfortable.

SAFETY SIGN

Each Limelight™ hot tub is shipped with a SAFETY SIGN in the owner's package. The sign, which is required as a condition of Product Listing, should be permanently installed where it is visible to the users of the hot tub. To obtain additional SAFETY SIGNS, contact your Limelight dealer and request Part #70798.

IMPORTANT HOT TUB INSTRUCTIONS

The following contains important hot tub information, and we strongly encourage you to read and apply them.

DO:

- Use and lock the vinyl cover when the hot tub is not in use, whether it is empty or full.
- Follow the hot tub Care and Maintenance recommendations stated in this manual.
- Use only approved accessories and recommended hot tub chemicals and cleaners.

DON'T:

- Leave the Limelight hot tub exposed to the sun without water or the cover in place. Exposure to direct sunlight can cause solar distress of the shell material.
- Roll or slide the hot tub on its side. This will damage the siding.
- Lift or drag the vinyl cover by using the tie-down straps; always lift or carry the cover by using the handles.
- Attempt to open the electrical control box. There are no user serviceable parts inside. Opening of the control box by the hot tub owner will void the warranty. If you have an operational problem, carefully go through the steps outlined in the Troubleshooting section. If you are not able to resolve the problem, contact your authorized Limelight dealer. Many problems can easily be diagnosed over the telephone by an Authorized Service Technician.

SAVE THESE INSTRUCTIONS

HOT TUB SPECIFICATIONS

| | Footprint dimensions | Height | Effective filter area | Heater (Watts) | Water capacity | Dry weight | Filled weight* | Dead weight | Electrical Requirements |
|--|--------------------------------|--------------|-----------------------|----------------|-----------------------------|---------------------|-------------------------|--------------------------|---|
| Limelight® Pulse® (Model PLS) Seats 6 Adults | 7' 5" x 7' 5" 2.26m x 2.26m | 38" 97 cm | 65 square feet | 4,000 | 380 gallons 1,438 litres | 920 lbs. 417 kg. | 5,154 lbs. 2,337 kg. | 115 lbs. per square foot | 230v System, 230 volt, 50 amp single phase GFCI protected circuit |
| Limelight Flair® (Model FLR) Seats 5 Adults | 7' 0" x 7' 0" 2.13m x 2.13m | 36" 91 cm | 65 square feet | 4,000 | 310 gallons 1,173 litres | 789 lbs. 358 kg. | 4,267 lbs. 1,935 kg. | 110 lbs. per square foot | 230v System, 230 volt, 50 amp single phase GFCI protected circuit |
| Limelight Glow® (Model GLW) Seats 4 Adults | 6' 4" x 7' 0" 1.93m x 2.13m | 33" 84 cm | 65 square feet | 4,000 | 270 gallons 1022 litres | 710 lbs. 322 kg. | 3,515 lbs. 1,594 kg. | 105 lbs. per square foot | 230v System, 230 volt, 50 amp single phase GFCI protected circuit |

CAUTION: Watkins Manufacturing Corporation suggests a structural engineer or contractor be consulted before the hot tub is placed on an elevated deck.

* **NOTE:** The "Filled weight" and "Dead weight" of the hot tub includes the weight of the occupants (assuming an average occupant weight of 175 lbs).

INSTALLATION INSTRUCTIONS

SITE PREPARATION

You probably have a spot picked out for your new hot tub, whether it's indoors or outdoors, on a patio or on a deck. Just make sure you check the following:

- Always put your hot tub on a structurally sound, level surface. A filled hot tub can weigh a great deal. Make certain that the location you choose can support the weight of your filled hot tub.
- Don't forget to level your hot tub before filling it. (See Hot Tub Leveling Instructions.)
- Locate your equipment compartment, which houses all of the electrical components, in a place where water drainage will be away from it. Do not allow water into the equipment compartment. Water can cause damage to the electronics, or may trip the circuit breaker on your house's electrical panel.
- Leave yourself easy access to the circuit breakers in the subpanel.
- Never let water get into the subpanel. Your 230 volt hot tub's subpanel is rain-tight when installed correctly with the door closed. Periodically check these conditions and correct any flaws if detected.
- Leave access to the equipment compartment for periodic hot tub care and maintenance.
- Your hot tub is equipped with an air-intake screen located between the base of the equipment compartment (center of compartment) and the ground. Make sure the screen remains clear of debris at all times, this is the only location that allows air to flow into the equipment compartment.

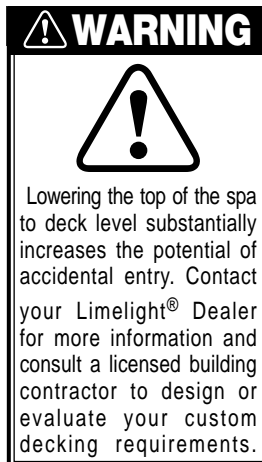

OUTDOOR AND PATIO INSTALLATION

No matter where you install your new hot tub, it's important that you have a solid foundation to support it. Structural damage to the hot tub resulting from incorrect installation, or placement on an inadequate foundation, is not covered under the hot tub's limited warranty.

If you install the hot tub outdoors, we recommend a reinforced concrete pad at least four inches thick. The reinforcing rod or mesh in the pad should be attached to a #10 AWG bonding wire per national electrical codes (contact your local electrical code compliance inspector for more information; inspection for proper grounding may be required before pouring concrete to form the slab).

If you place the hot tub on the ground, even temporarily, place stepping stones under the leveling areas (see Hot Tub Leveling Instructions). The stones should be at least two inches thick and twelve inches square. Even with stones in place, the hot tub will inevitably settle and become unlevel. Plus, a hot tub surrounded by dirt or grass will soon be filled with dirt or grass from users' feet; therefore, it's important to get it onto a solid foundation as soon as possible.

DECK INSTALLATION

To be certain your deck can support your hot tub, you must know the deck's maximum load capacity. Consult a qualified building contractor or structural engineer. To find the weight of your hot tub, its contents and occupants, refer to the Hot Tub Specification chart. This weight per square foot must not exceed the structure's rated capacity, or serious structural damage could result.

INDOOR/BASEMENT INSTALLATION

Be aware of some special requirements if you place your hot tub indoors. Water will accumulate around the hot tub, so flooring materials must provide a good grip when wet. Proper drainage is essential to prevent a build-up of water around the hot tub. When building a new room for the hot tub it is recommended that a floor drain be installed. The humidity will naturally increase with the hot tub installed. Water may get into woodwork and produce dry rot, mildew, or other problems. Check for airborne moisture's effects on exposed wood, paper, etc. in the room. To minimize these effects, it is best to provide plenty of ventilation to the hot tub area. An architect can help to determine if more ventilation must be installed.

Your Limelight dealership can help you with local information such as zoning regulations and building codes. They can also give you a copy of our planning guide – just ask for Limelight hot tub Pre-Delivery Instructions.

- ⚠ **WARNING:** Please keep the area around your hot tub well ventilated when it is installed indoors or in a confined area. Inadequate ventilation around the hot tub could cause a build-up of a higher-than-normal concentration of hot tub chemicals and/or bacterial fragments. These dispersed hot tub chemicals and/or bacterial fragments can be inhaled, and may result in breathing difficulties or lung damage in certain people suffering from a compromised immune system or respiratory infection. If you or other bathers are affected by this condition, please seek medical attention as soon as possible.

In addition to the previous information, properly clean and maintain your hot tub as follows:

- Follow all procedures in this Owner's Manual and printed instructions on all water care (chemical) products packaging.
- Test the water regularly to ensure proper levels of sanitizers, pH, and other water care requirements.
- Drain, clean, and refill your hot tub with fresh water on a regular schedule, and in accordance with this owner's manual.
- Clean the filter(s) at least once per month.
- Check to make sure you have proper circulation throughout your hot tub water system.
- Have hot tub users bathe before entering the hot tub water.

HOT TUB LEVELING INSTRUCTIONS

In order for your Lighthouse[®] hot tub to operate properly, and the internal plumbing to drain completely, the hot tub must be level.

⚠ **WARNING:** Watkins Manufacturing Corporation recommends that a structural engineer or contractor be consulted prior to placing the hot tub on an elevated deck, or platform.

IMPORTANT: Watkins Manufacturing Corporation reserves the right to change any specifications or design without incurring any obligation.

Hot Tub Leveling Preparation

Concrete sloped at 1/2 inch (1.3 cm) per 10 feet (305 cm) is preferred so that rain water and water spillover will run off and not puddle underneath the hot tub (water under the hot tub for long periods of time may cause the wood to deteriorate). Other options are brick, stepping stone, or blocks.

It is important to note that soft surfaces, even when stepping stones are used to evenly distribute the weight of the hot tub, will have a tendency to settle, thus resulting in an unlevel hot tub.

NOTE: Placing the hot tub on grass or dirt may increase the amount of debris which is inadvertently brought into the hot tub water and may cause harm to your equipment as well as the hot tub surface, which is not covered under warranty.

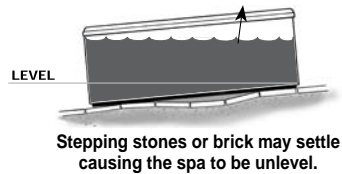
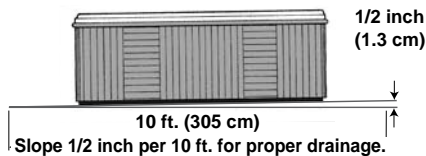

CONTROLS AND EQUIPMENT

LIMELIGHT® PULSE® MODEL (PLS)

OVERHEAD VIEWS

- A. Combination XL Hydromassage jets
- B. Combination Hydromassage jets
- C. Direct Hydromassage jets
- D. Secondary suction
- E. Hot tub pillow
- F. Filter compartment
- G. Control panel
- H. Air Lever for Direct Hydromassage jets
- I. Diverter Lever
- J. Cup holder
- K. Water Feature lever
- L. Water Feature
- M. Heater jet / Ozone (optional accessory)
- N. Speaker (optional accessory)



EQUIPMENT COMPARTMENT

- 1. Silent Flo 5000® Circulation pump
- 2. Wavemaster® jet pump
- 3. No-Fault® heater
- 4. IQ 2020® hot tub control box
- 5. Drain valve
- 6. Ozone injector (optional accessory)
- 7. Bonding terminal

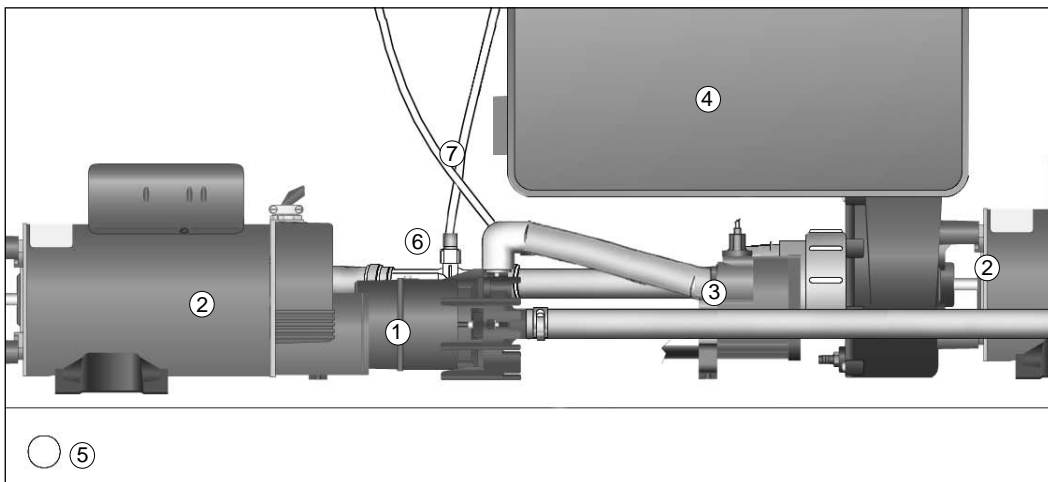

LIMELIGHT[®] FLAIR[®] MODEL (FLR)

OVERHEAD VIEWS

- A. Combination XL Hydromassage jets
- B. Combination Hydromassage jets
- C. Direct Hydromassage jets
- D. Secondary suction
- E. Hot tub pillow
- F. Filter compartment
- G. Control panel
- H. Air Lever for Direct Hydromassage jets
- I. Diverter Lever
- J. Cup holder
- K. Water Feature lever
- L. Water Feature
- M. Heater jet / Ozone (optional accessory)
- N. Speaker (optional accessory)

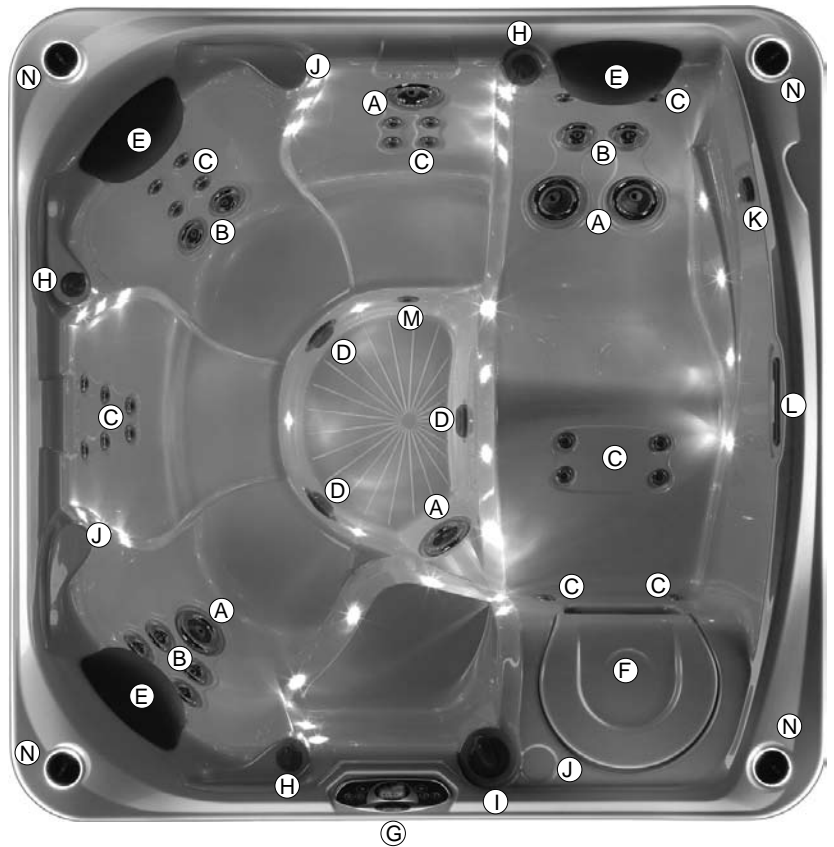

EQUIPMENT COMPARTMENT

- 1. Silent Flo 5000[®] Circulation pump
- 2. Wavemaster[®] jet pump
- 3. No-Fault[®] heater
- 4. IQ 2020[®] hot tub control box
- 5. Drain valve
- 6. Ozone injector (optional accessory)
- 7. Bonding terminal

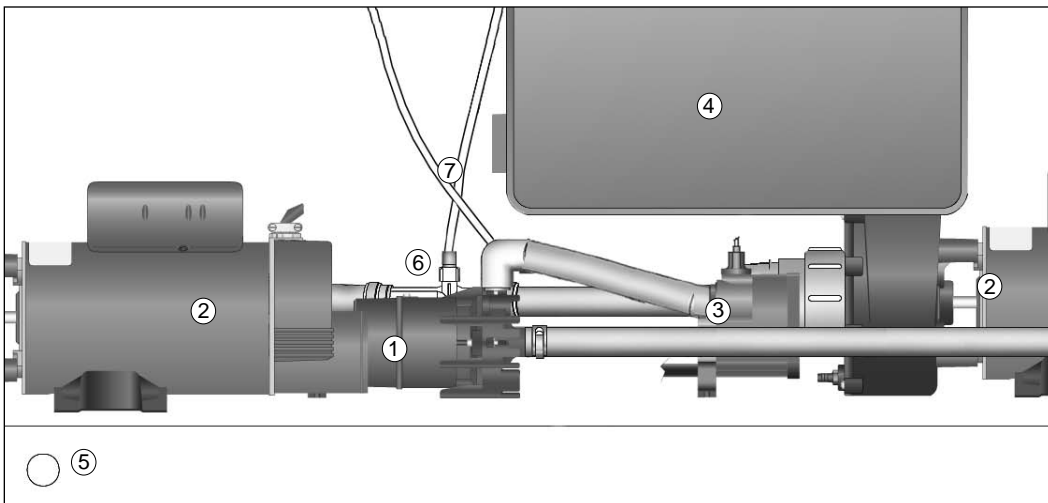

LIMELIGHT[®]

GLOW[®]

MODEL (GLW)

OVERHEAD VIEWS

- A. Combination XL Hydromassage jets
- B. Combination Hydromassage jets
- C. Direct Hydromassage jets
- D. Secondary suction
- E. Hot tub pillow
- F. Filter compartment
- G. Control panel
- H. Air Lever for Direct Hydromassage jets
- I. Cup holder
- J. Water Feature lever
- K. Water Feature
- L. Heater jet / Ozone (optional accessory)
- M. Speaker (optional accessory)



EQUIPMENT COMPARTMENT

- 1. Silent Flo 5000[®] Circulation pump
- 2. Wavemaster[®] jet pump
- 3. No-Fault[®] heater
- 4. IQ 2020[®] hot tub control box
- 5. Drain valve
- 6. Ozone injector (optional accessory)
- 7. Bonding terminal

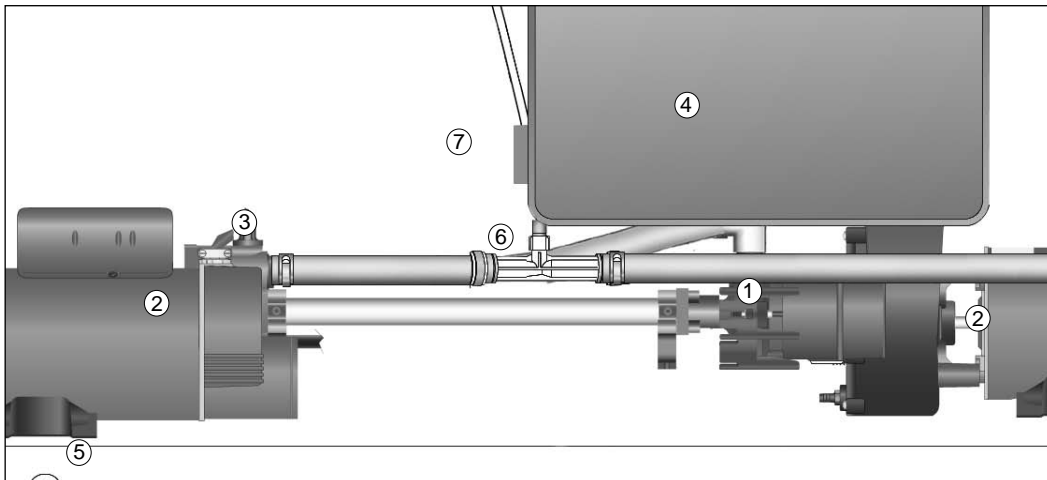

ELECTRICAL REQUIREMENTS AND PRECAUTIONS

Your Limelight® hot tub has been carefully designed to give you maximum safety against electric shock. Connecting the hot tub to an improperly wired circuit will negate many of the hot tub's safety features. Improper wiring may also cause electrocution, risk of fire, and other risks of injuries. Please read and follow the electrical installation requirements and instructions for your specific hot tub model completely!

SERVICE NOTE: The Limelight hot tub is equipped with a power indicator which, in addition to showing the hot tub has power to it, has a diagnostic function as well. It will begin blinking if the heater high-limit thermostat has tripped. If the power indicator light is blinking, follow the instructions in the Troubleshooting section to identify and correct the cause. The power indicator will stop blinking once the problem has been corrected.

230 VOLT CONNECTED

ELECTRICAL REQUIREMENTS

LIMELIGHT HOT TUB MUST BE WIRED IN ACCORDANCE WITH ALL APPLICABLE LOCAL ELECTRICAL CODES. ALL ELECTRICAL WORK SHOULD BE DONE BY AN EXPERIENCED, LICENSED ELECTRICIAN. WE RECOMMEND THE USE OF APPROPRIATE ELECTRICAL CONDUIT, FITTINGS, AND WIRE FOR ALL CIRCUITS.

An electrical subpanel containing two GFCI breakers is included with each 230 volt hot tub. We recommend that this subpanel be used to supply power and protect the hot tub.

This subpanel requires a 50 amp, single phase, 230 volt, four wire service (two line, one neutral, one ground). The grounding conductor must not be less than #10 AWG. Refer to local codes and to NEC 250-122 (table).

Mount the subpanel in the vicinity of the hot tub, but not closer than five feet away, in accordance with all local codes. (N.E.C. 680-38 to 41-A-3).

INSTALLATION INSTRUCTIONS

1. To connect the electrical service, first remove the screws from the equipment compartment panel. Carefully pull the door panel away and down in order to remove it completely from the hot tub.
2. Locate the IQ 2020® hot tub control box. Loosen the screws on the front of the control box. Remove the screws and the control box cover.
3. Route the electrical service from the subpanel into the hot tub equipment compartment.
NOTE: The subpanel must be placed in sight of the hot tub, at a minimum distance of five feet away.
4. Connect the supply conduit to the bottom of the IQ 2020 hot tub control box, using a 3/4" liquid-tight, flex conduit fittings.

WIRING CONNECTIONS

1. Identify the TB-1 terminal block, located inside the control box at the lower left-hand corner.
2. Connect the #12 AWG, BLUE wire, from the subpanel 20 amp breaker, terminal L1 to TB-1, terminal 2.
3. Connect the #12 AWG, RED wire, from the subpanel 20 amp breaker, terminal L2 to TB-1, terminal 4.
NOTE: The WHITE neutral wire must be attached to the LOAD neutral on the 230 volt, 30 amp breaker (not to the neutral bus bar in the subpanel). The WHITE neutral wire coming from the breaker itself is already connected to the neutral bus bar.
4. Connect the #10 AWG, BLUE wire, from the subpanel 30 amp breaker, terminal L1 to TB-1, terminal 5.
5. Connect the #10 AWG, RED wire, from the subpanel 30 amp breaker, terminal L2 to TB-1, terminal 6.
6. Connect the #10 AWG, WHITE wire, from the subpanel 30 amp breaker, terminal N (load neutral) to TB-1, terminal 7.
7. Connect the #10 AWG, GREEN wire, from the subpanel GROUND bar to TB-1, system ground terminal.
8. Using the pressure wire connector provided on the outside of the control box, bond the hot tub to all exposed metal equipment or fixtures, handrails, and the concrete pad (if applicable) per N.E.C. and local codes.
9. Replace the control box cover and securely tighten the fastening screws. Close and secure the equipment compartment panel as follows:
 - Place top of panel directly below bartop against the frame of the hot tub.
 - Push bottom of panel against the hot tub frame.
 - Slide panel upward until screw holes line up.
 - Slightly pull on panel, if door remains against the hot tub then replace the screws.

Limelight® Hot Tubs 230 volt permanently connected models

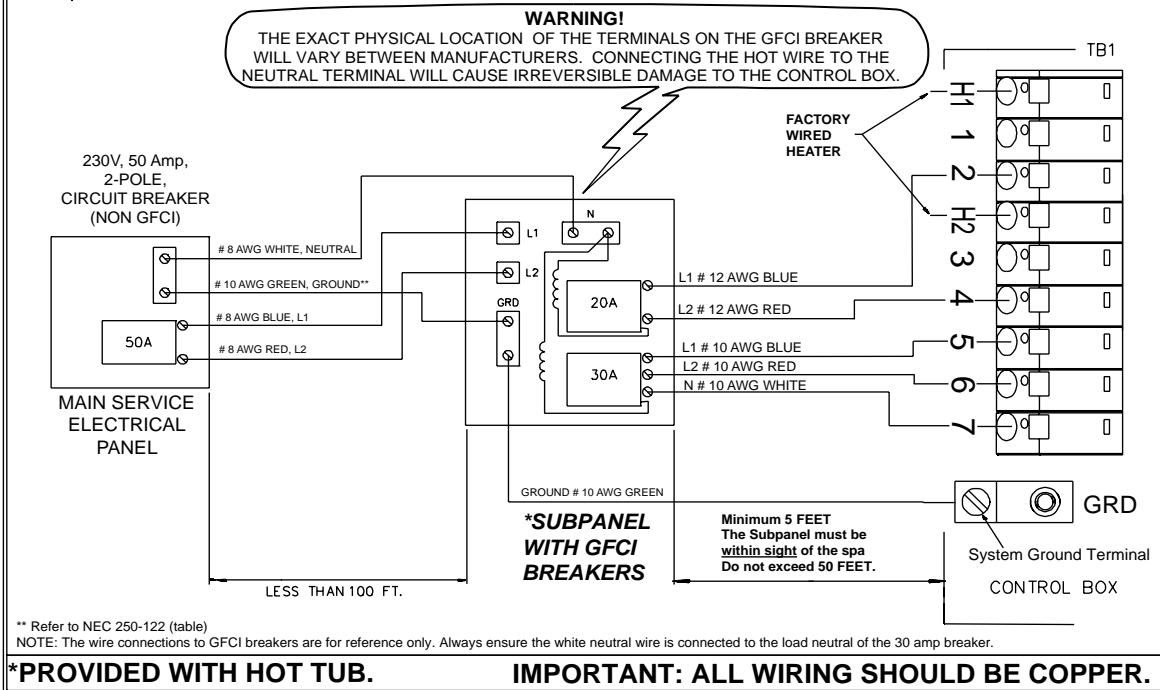

⚠ WARNING: FILL THE HOT TUB WITH WATER BEFORE TURNING ON THE POWER! (See STARTUP AND REFILL PROCEDURES).
Once your hot tub has been filled with water, turn it on and test all of the circuit breakers.

NOTE: If both breakers immediately trip, verify that the #10 AWG WHITE neutral wire is connected from TB-1 terminal 7 to the N (load neutral) terminal of the 30 amp subpanel breaker. Each breaker should be tested prior to each use. Here's how:

1. Push the "TEST" button on each GFCI breaker, and observe it click OFF.
2. Wait 30 seconds, then push the breaker switch to the OFF (down) position (to ensure that it has completely disengaged), then push the breaker switch to the ON (up) position. If you don't wait 30 seconds, the hot tub's control panel may flash four lines on and off – try again.

If any of the GFCI breakers fails to operate in this manner, your hot tub may have an electrical malfunction, and you may be at risk of electrical shock. Turn off all circuits and do not use the hot tub until the problem has been corrected by an authorized service agent.

⚠ WARNING: Removing or bypassing any GFCI breaker will result in an unsafe hot tub and will void the hot tub's warranty.

IMPORTANT: Should you ever find the need to move or relocate your Limelight hot tub, it is essential that you understand and apply these installation requirements. Your Limelight hot tub has been carefully engineered to provide maximum safety against electric shock. Remember, connecting the hot tub to an improperly wired circuit will negate many of its safety features.

NOTE: Long wiring runs may require larger-gauge wire than stated.

OPERATING INSTRUCTIONS

Limelight® Hot Tubs are 230 volt permanently connected models. The Limelight Pulse®, Flair® and Glow® use a continuous heating system, this means that the heater may turn on while the jet pump is operating which keeps your water hotter longer when the jets are in use.

Your Limelight hot tub comes with a subpanel which contains two GFCI circuit breakers - a 20 amp / 30 amp / 230 volt GFCI circuit breaker system. The subpanel and hot tub must be "hardwired" by a licensed electrician using appropriate wire, conduit, and fittings.

The Limelight Pulse features one Wavemaster® 9000 (2 1/2hp single speed) jet pump and one Wavemaster 9200 (2 1/2hp two speed) jet pump. The Limelight Flair and Glow feature one Wavemaster 8000 (2 hp single speed) jet pump and one Wavemaster 8200 (2 hp two speed) jet pump. The hot tubs have a No-Fault® titanium, high watt density heater. The heating system consists of a 4,000 watt (4 kW) heater. The Limelight hot tubs are also equipped with an energy efficient low-flow circulation pump, and a high-limit thermostat for protection of user and equipment.

The heater will turn on while the jet pump is operating (after a 1-1/2 degree temperature drop) to help maintain the water temperature during hot tub use. Factors such as the number of people using the hot tub, the air temperature, and the length of time the pump is operated will affect the heating system's ability to maintain the water temperature.

START-UP AND REFILL PROCEDURES

Your Limelight hot tub has been thoroughly tested during the manufacturing process to ensure reliability and long-term customer satisfaction. A small amount of water may have remained in the plumbing after testing and, as a result, may have spotted the hot tub shell or the hot tub siding prior to delivery. Before filling the hot tub, wipe the hot tub shell clean with a soft rag.

The following instructions must be read and followed exactly to ensure a successful start-up or refill.

CAUTIONS

- Do not fill the hot tub with hot water, as tripping of the high-limit thermostat may result.
 - DO NOT CONNECT POWER TO AN EMPTY HOT TUB. Power to the hot tub automatically activates critical components within the hot tub, such as controls, heater, circulation pump, and other systems. If power is supplied to these components prior to the hot tub being filled, the components will be damaged, and this may result in a non-warranty component failure.
 - Do not use your hot tub after filling until all of the steps listed below are completed.
 - Do not add chlorine if treating your hot tub with polyhexamethylene biguanide (Biguanide, PHMB, eg. BaquaSpa®) sanitizer.
 - Do not use the FrestStart® 10,000 pre-filter if treating your hot tub with a polyhexamethylene biguanide (Biguanide, PHMB, i.e. BaquaSpa) sanitizer.
1. Close drain and fill the hot tub with water through the filter compartment. The water level of your Limelight hot tub should be maintained just below the bottom of the pillow.
RECOMMENDED: Use the FreshStart 10,000 pre-filter to remove unwanted contaminants from the tap water.
IMPORTANT: Watkins Manufacturing Corporation does not recommend that the hot tub be filled with "softened" water, as this may damage the hot tub's equipment.
 2. **AFTER** the hot tub has been filled with water and the equipment compartment door is secured, power must be applied to the hot tub.
 - Open the door of the electrical subpanel and reset the 30 amp GFCI breaker, verify that the system is primed (see step 3), then reset the 20 amp breaker. Close and secure the subpanel door.
 3. The jet pump, heating system, and all internal plumbing will achieve a partial prime as the hot tub is filled. To check the operation of the jet system and to remove any remaining air from the heating system, push the JETS button two times to make the jet pumps run on high speed, run for one minute. Once the jet system is fully operational (as indicated by strong, non-surgings jets), priming of the hot tub is complete. Weak or surging jets are an indication of a low water level condition or clogged filter cartridges.
IMPORTANT: Be sure the air control valves (see illustration in Air Control System section) are open by turning each one clockwise and checking to see that the Diverter lever is pointing to the 3 o'clock position for the Flair model and 6 o'clock position for the Pulse model (see illustration in Diverter System section). Combination jet faces can be turned to completely shut off jet flow, these jets should be open as well.
 4. Adjust Total Alkalinity (TA) to 80 ppm, Calcium Hardness (CH) to 100 ppm, then hot tub water pH to between 7.4 and 7.6 These procedures are listed in the "Water Quality and Maintenance" section.
IMPORTANT: Add hot tub water chemicals directly into the filter compartment with the jet pump on high speed for at least ten minutes.
OPERATION NOTE: Adjusting the Total Alkalinity as the first step is important, as out-of-balance TA will affect your ability to adjust the pH correctly and will prevent the sanitizer from operating effectively.
 5. Superchlorinate the hot tub water by adding 1-1/2 teaspoons of chlorine (sodium dichlor) per 250 gallons (950 liters) of hot tub water. Run the jet pump for a ten-minute period (clean cycle).
 6. During the super-chlorination period, rotate the diverter lever through both operating positions, letting the hot tub water circulate (with jets on) for equal periods of time. For example, leave the diverter lever in each position for approximately two to three minutes.

OPERATION NOTE: Depending on your hot tub, the diverter lever is designed to operate in either the 3 o'clock and 9 o'clock positions or in the 6 o'clock and 12 o'clock positions (the Glow[®] does not use a diverter lever).

7. Set the temperature control to the desired temperature between 100°F and 104°F (36°C and 40°C), then place the vinyl cover on the hot tub and allow the water temperature to stabilize (approximately 24 hours). Make sure you secure the cover in place using the cover locks. Periodically check the hot tub water temperature. When the water temperature climbs above 90°F (32°C), proceed to the next step.
8. Rotate the diverter lever to the primary position (3 o'clock for the Flair[®] model or 6 o'clock for the Pulse[®] model) and turn on the jets for ten minutes to circulate the hot tub water. After the jets have run for ten minutes (clean cycle), test the hot tub water for Free Available Chlorine (FAC) residual. If the residual is between 3 and 5 ppm on the test strips (found in the test kit) go on to the next step. If the residual is less than 3 ppm, superchlorinate the hot tub water by adding 1-1/2 teaspoons of chlorine (sodium dichlor) per 250 gallons (950 liters) of hot tub water. Run the jet pump to circulate the hot tub water for a ten-minute period (clean cycle).
9. Rotate the diverter lever to next position (9 o'clock for the Flair model or 12 o'clock for the Pulse model) and let the hot tub water circulate (using the jet) for ten minutes. Test the hot tub water for Free Available Chlorine (FAC) residual. If the residual is between 3 and 5 ppm on the test strips (found in the test kit) go on to the next step. If the residual is less than 3 ppm, superchlorinate the hot tub water by adding 1-1/2 teaspoons of chlorine (sodium dichlor) per 250 gallons (950 liters) of hot tub water. Run the jet pump to circulate the hot tub water for a ten-minute period (clean cycle).
10. Recheck the Total Alkalinity (TA) at 80 ppm, Calcium Hardness (CH) at 100 ppm, then hot tub water pH at between 7.4 and 7.6.

Operational Note: Make sure you adjust your Total Alkalinity first, as an out-of-balance condition will affect your ability to adjust the pH correctly, and will prevent the sanitizer from operating effectively. **The hot tub is ready for use when the hot tub water has circulated through both diverter lever operating position and the chlorine level remains between 3 ppm and 5 ppm.**

11. The hot tub temperature is pre-programmed to reach 100°F (38°C), and will normally do so within 18 to 24 hours. You may raise the water temperature by pressing the TEMP (+) button on the control panel, or lower it by pressing TEMP (-) button. After a few hours, the water temperature will remain within 1-1/2 degrees of your selected temperature. To prevent tampering, you can lock your desired temperature setting. Refer to the Control Panel section for details.

NOTE: Allowing the jet pump to operate for long uninterrupted periods of time with the cover in place will cause a rise in the hot tub water temperature. All hot tubs are equipped with a safety device to reduce the risk of component damage or personal injury, should the jet pump be left running continuously for a long period of time. After two hours of continuous operation, the jet pump controller will automatically turn off the jet pump.

DIVERTER SYSTEM (PULSE & FLAIR ONLY)

With your Limelight[®] hot tub's diverter system design, you can control the massaging action of your hot tub. Using the diverter lever, the jets are activated in sets, known as jet systems.

The Limelight Pulse hot tub has two jet systems that are activated by turning the diverter lever to the 6 or 12 o'clock position while the Limelight Flair has two jet systems that are activated by turning the diverter lever to the 3 or 9 o'clock position. To access a different jet system, simply turn the diverter system lever. The orientation is based on standing at the control panel.

Please consult the jet system menus on the following page to determine which jets are activated with each diverter lever position. Or just jump in and play – turn the lever and see what happens.

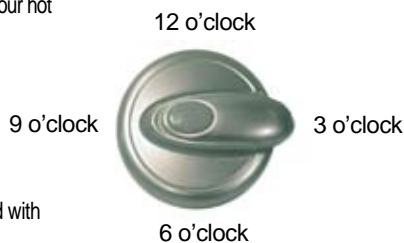

AIR CONTROL SYSTEM

The Air Control System allows you to control the intensity of the Direct Hydromassage jets by adjusting the mixture of air and water. Turn the Air Control lever clockwise to decrease the intensity of the Direct Hydromassage jets and counterclockwise to increase the intensity.



JETS

DIRECT HYDROMASSAGE JETS

Direct Hydromassage jets are small, producing a precisely narrow stream of massaging action. They are placed in groups to perform a soft, soothing massage on your back, neck, and shoulders.

COMBINATION HYDROMASSAGE JETS

These jets deliver a great massage to the feet, back and shoulder areas. These jets may be adjusted to provide either a stationary, direct stream, or, by positioning the nozzle to one side, a variety of rotating massage patterns. Also, the speed of the rotation can be changed by rotating the jet faceplate from a full stream, to shutting the jet completely off. To avoid damage to your spa's plumbing and components, do not turn off more than half of these jets at the same time.



COMBINATION XL HYDROMASSAGE JETS

These large jets may be adjusted to provide either a stationary, direct stream, or, by positioning the nozzle to one side, a variety of rotating massage patterns. Also, the speed of the rotation can be changed by rotating the jet faceplate from a full stream, to shutting the jet completely off. To avoid damage to your spa's plumbing and components, do not turn off more than half of these jets at the same time.



COMBINATION JETS MAINTENANCE

If you notice that either the Combination or Combination XL jets spin slower than when the spa was new, or the jets are sticking, the cause may be built-up deposits inside the jet bearings. To remove the deposits, use the following instructions:

1. With the spa off, rotate the combination jet face counter-clockwise until it stops.
2. Once the face stops rotating, push in and use a little extra force to rotate the face even more counter-clockwise past the locking position until it stops. Pull face with the body away from the spa.
3. After flushing the bearing inside the body with water, spin the rotating eye, it should spin very freely. If it does not, place the bearing end in a cup of vinegar (the vinegar will soften any deposits). Leave soaking overnight. The next day, flush with water and repeat the spin test.

NOTE: If it still doesn't spin freely, a second night of soaking is required. If the bearing still does not spin, you will need to purchase a replacement assembly from your Limelight® dealer.

4. To replace, position the cutout at the back end of the face body downward and push the face body back into the spa fitting. Slightly rotate face body in either direction until you feel the body align with the fitting, then press firmly on the face body. Once seated, push and rotate the face clockwise using a little extra force to overcome the locking position. If the face does not rotate, remove and rotate face body 180° and repeat this step. Turn the jet pump on, the combination jet should spin freely.

WATER FEATURE

The Limelight Pulse®, Flair®, and Glow® hot tubs come equipped with a Vidro™ water feature. This water feature can be turned on or off when the two-speed pump is on low speed (tranquil mode) or high speed. To function correctly, the water feature on/off lever must be placed in the full on position only.

If the lever is not in the full on position when the pump is on high speed, it is likely that the water feature will project water substantially farther out into the hot tub as the on/off lever is opened. This is not proper operation. If this occurs, the pump should be turned off, the water feature lever rotated to the full on position and the pump turned on again.

When not in use turn the on/off lever to the OFF position.

CAUTION: Partial blockage of water flow at entrance of water feature will cause the water to flow farther into or over the hot tub.

JET SYSTEM MENU

LIMELIGHT[®] PULSE[®] (MODEL PLS)



Jet Pump 1

- 2 Combination XL jets on left back wall
- 2 Direct jets on right back wall
- 2-Combination jets on right front wall
- 6 Direct jets in footwell
- 2 Combination jets on left front wall
- 1 Water Feature (left wall) lever must be in ON position



Jet Pump 2 - Jet System 1

Diverter lever in the 6 o'clock position

- 6 Direct jets on back wall
- 8 Direct jets on right back wall
- 1-Combination XL jets on right front wall
- 4 Direct jets on left wall



Jet Pump 2 - Jet System 2

Diverter lever in the 12 o'clock position

- 4 Direct jets on left back wall
- 2 Combination jets on left back wall
- 2 Direct jets in footwell
- 2 Direct jets on right front wall
- 6 Direct jets on front left wall
- 1-Combination XL jet on left wall

LIMELIGHT® FLAIR® (MODEL FLR)



Jet Pump 1

- 2 Combination jets on left back wall
- 2-Combination jets on right back wall
- 4 Direct jets in lounge footwell
- 1 Combination XL jet in footwell
- 1 Combination XL jet on front left wall
- 1 Water Feature (right wall) lever must be in ON position

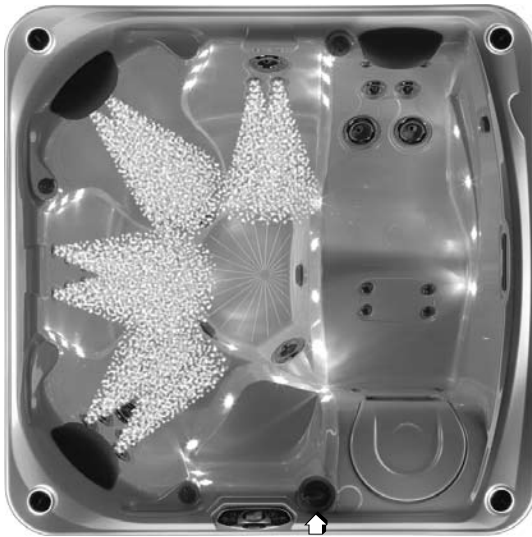

Jet Pump 2 - Jet System 1 **Diverter lever in the 3 o'clock position**

- 6 Direct jets on left back wall
- 4 Direct jets on back wall
- 2-Combination jets on left front wall
- 6 Direct jets on left wall



Jet Pump 2 - Jet System 2 **Diverter lever in the 9 o'clock position**

- 1 Combination XL jet on back wall
- 4 Direct jets on right back wall
- 2 Combination XL jets on right back wall
- 4 Direct jets in lounge (calf area)
- 2-Combination jets on left front wall

LIMELIGHT[®] GLOW[®]

(MODEL GLW)



JET PUMP 1

- 10 Direct jets on left back wall
- 6 Direct jets on right back wall
- 2-Combination jets on right back wall
- 1 Water Feature (right wall) lever must be in ON position



JET PUMP 2

- 4 Direct jets on front right wall
- 1-Combination XL jet on front right wall
- 1-Combination XL jet on front left wall
- 2 Direct jets on front left wall
- 2-Combination jets on front left wall
- 2-Combination jets in footwell

CONTROL PANEL OPERATIONS

CONTROL PANEL

Your Limelight® hot tub comes equipped with a control panel located on the bartop above the equipment compartment door. The control panel allows the user to set the temperature, activate the jets and light, and access menus to lock the temperature and/or hot tub functions, and uses indicator lights and an integrated LCD display to provide a quick visual check of the hot tub's status.



CONTROL PANEL BUTTON AND DISPLAY

The control panel has buttons which the hot tub user presses to set the temperature, turn the light on and off, activate or deactivate the jet pumps and several other functions depending on what has been added to your hot tub. The control panel display responds to let you know you've pressed a button, and that the selected function has been performed. After a period of non-use, pressing any button will wake up a sleeping display, as well as performing its function. Function icons when in active mode will remain lit during the sleeping display.

Control Panel Buttons



Control Panel Display

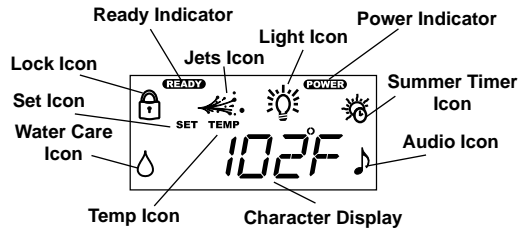

JETS CONTROL

The JETS button activates the jet pump. When the JETS button is pressed, the JETS symbol will illuminate on the control panel display. The symbol will remain lit until the button is pressed to turn off the jet pump, or after two hours of continuous operation when the pump is automatically shut off by the control system.

If the jet pump will not engage, make sure SPA LOCK is deactivated.

Pressing the JETS button operates the jets as follows:

- 1st press = low speed of jet pump 1
- 2nd press = high speed of jet pump 1
- 3rd press = high speed of jet pump 1 & 2
- 4th press = high speed of jet pump 2 and low speed of jet pump 1
- 5th press = high speed of jet pump 2
- 6th press = jet pumps OFF

LIGHT

All Limelight™ hot tubs come equipped with Raio™ light system to enhance hot tub use at night. The hot tub uses a specially designed low voltage dimmable LED light source.

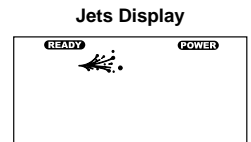

LIGHT - ON/OFF & INTENSITY CONTROLS

The light control uses four positions: High, Medium, Low, and Off. To turn on the hot tub light, press the LIGHT button. This will place all lights in the hot tub in the High, or maximum intensity position. When the lights turn on, the light symbol will also illuminate on the control panel display. Press the LIGHT button again to lower the intensity of the lights to the Medium position. Press the LIGHT button again to lower the intensity even more, placing the lights intensity in the Low position. Press the LIGHT button one more time to shut the lights off. When the light is deactivated, the light symbol will also turn off.

If the lights are left on, they will automatically be turned off by the control system after 6 hours of continuous operation. The light symbol on the panel will also turn off when the lights are deactivated.

If the lights will not turn on, make sure SPA LOCK is deactivated. SPA LOCK disables the controls on the control panel (see following pages for more information on SPA LOCK).

Light Display



LIGHT - MULTI-COLOR MENU CONTROLS

Your hot tub lights can display a variety of different colors as well as run through a continuous sequence of colors (loop) at different speeds. To activate this function the following is required:

On the control panel press the LIGHT button first (light will activate), then press the MODE ▲ or MODE ▼ button to scroll to the LITE+ menu. Once displayed, press the ON ▲ button to enter the Lite menu. Press the MODE ▲ or MODE ▼ button to scroll from COLOR - LOOP# - EXIT screens. Press the ON ▲ button or OFF ▼ button in the COLOR screen as many times as desired to toggle through the different light colors. Press the ON ▲ button or OFF ▼ button in the LOOP screen to select a continuous sequence of colors, the higher the loop number the faster the color sequence will run. Press the ON ▲ button in the EXIT screen to exit the LITE+ menu.

If the light is turned off while in the LOOP or COLOR mode, the same mode will exist when the light is reactivated.

INDICATOR LIGHTS

At a glance, the indicator lights are readily visible on the main control panel. The two indicator lights (POWER and READY) work independently from the rest of the control panel display. That way, even if the control panel is off, you can simply glance at the "READY" indicator light to determine whether or not your hot tub is within the range of your set temperature.

Power indicator: The POWER indicator is 'on' when the hot tub is properly supplied with power. It also provides a diagnostic function – a blinking POWER indicator indicates that the heater high-limit has tripped, meaning that either the hot tub water is above its acceptable temperature range, or a malfunction has occurred within the hot tub (such as low circulation due to a clogged filter). An 'off' POWER indicator means that there is a problem with the hot tub control panel or the power supplied to the hot tub.

Ready indicator: The READY indicator will light when the hot tub water temperature is within 2½°F of the set temperature, and will turn off when the temperature is outside of that range. If you increase or decrease the temperature setting of the hot tub, the READY indicator will turn off until the hot tub temperature reaches the acceptable range for the new set temperature. Additionally, a blinking READY indicator indicates that a problem exists with the temperature sensor.

CONTROL PANEL MENU DISPLAY

The control panel consists of four main menus. These menus are; Set Temperature, System, Lite+ and Tools. Press the MODE ▲ or MODE ▼ button to scroll through the main menus. Once the desired menu is illustrated, press the ON ▲ button to activate the menu.

TEMPERATURE CONTROL

The set temperature range is from 80°F to 104°F (27°C to 40°C). (The temperature of any setting may rise slightly depending on the current use and condition of your hot tub, and on outside temperature.)

The set temperature of the hot tub water will automatically be 100°F (38°C) the first time power is applied. This is the setting programmed at the factory. After the hot tub has been set up and used, the last temperature value set by the user will be stored in memory. If power is disconnected from the hot tub, it will automatically revert to the last set temperature when power is reapplied.

To display the set temperature of the hot tub, press the ON ▲ button. The set temperature will be displayed, unless the hot tub is locked (in which case the lock icon is displayed). The set temperature display will automatically shut off after 30 seconds.

To increase the set temperature of the hot tub water, press ON ▲ button. Each time the button is pressed, the set temperature display will increment by one degree. If the button is held down, the set temperature display will increase by one degree every half-second.

To decrease the set temperature of the hot tub water, press the OFF ▼ button. Each time the button is pressed, the set temperature display will decrement by one degree. If the button is held down, the set temperature display will decrease by one degree every half-second.

If the set temperature value will not change, check the TEMPERATURE LOCK and SPA LOCK features (see following pages for more information on TEMPERATURE LOCK & SPA LOCK). When either of these features is applied, the temperature control is disabled. To activate the temperature control buttons, remove all locking features applied.

Set Temperature Display

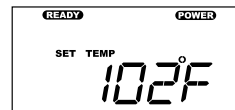

SYSTEM MODE

Your Limerlight® hot tub is equipped with a System Mode. This function will allow you to conveniently turn the jet(s) on high speed and the light on maximum intensity at the same time.

To activate the system mode, perform the following functions:

Press the MODE ▲ button until the SYSTM symbol is illuminated on the display. The jets and light icons will flash until the system mode is activated. Press the ON ▲ button to activate the SYSTM mode feature.

NOTE: Once activated, the jet and light functions can still be changed by pressing the JETS or LIGHT button.

To deactivate the system mode, press the MODE ▲ button until the SYSTM symbol is illuminated on the display. Press the OFF ▼ button to deactivate.

System Display Active

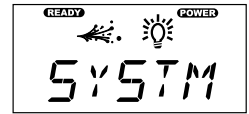

TOOLS MENU

The TOOLS menu is one of the main menus on the control panel. Within the TOOLS menu are six submenus, which consists of; Clean, Temp Lock, Spa Lock, Summer Timer and Exit.

To enter into the TOOLS menu, scroll through the main menus using the MODE ▲ or MODE ▼ button until the TOOLS menu is illustrated. Press the ON ▲ button to enter into the TOOLS submenu, use the MODE ▲ or MODE ▼ button to scroll through the submenus. Once the desired submenu is illustrated, press the ON ▲ button to activate the submenu or press the OFF ▼ button to deactivate the submenu. To leave the TOOLS submenu, scroll through the submenu until EXIT is illustrated, press the ON ▲ button to exit the submenu.

Tools Display

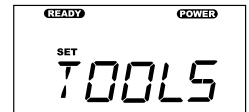

CLEANING MODE

All Limerlight hot tubs are equipped with a "Cleaning" mode. When the mode is activated, the jet pump in the first jet system will turn on and run for ten minutes (used for water maintenance). To activate the "Cleaning" mode, press the MODE ▲ or MODE ▼ button until the TOOLS menu is illustrated. Then press the ON ▲ button to enter the TOOLS submenus. The CLEAN symbol will illuminated (the CLEAN mode is the first submenu) on the display. Press the ON ▲ button to activate the CLEAN mode feature.

NOTE: The jet icon will remain solid in the CLEAN display and will flash on and off in the main display while the "Cleaning" mode is active.

To stop the Cleaning Cycle before the ten minutes is complete, Press the MODE ▲ button until the TOOLS menu is illuminated then press the ON button to enter the TOOLS submenus where the CLEAN symbol is illuminated on the display. Press the OFF ▼ button to deactivate.

NOTE: Pressing the JETS button will also deactivate the clean cycle.

Clean Cycle Active

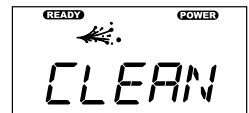

LOCKING FEATURES

The two locking features, SPA LOCK and TEMPERATURE LOCK, are enabled from the control panel by pressing the MODE ▲ or MODE ▼ button until the TOOLS menu is illustrated. Then press the ON ▲ button to enter the TOOLS submenus. Use the MODE ▲ or MODE ▼ button to scroll through the submenus to get to the locking features. Once enabled, a lock will remain active until the specific button combination is applied to disable the lock. Even if power is disconnected from the hot tub and soon thereafter reapplied (such as in a power outage) the lock will remain in place.

TEMPERATURE LOCK

The TEMPERATURE LOCK feature deactivates the temperature control function of the control panel. The jets and the light functions will operate normally. TEMPERATURE LOCK is most often used by people who do not want others to tamper with or change the set temperature of the hot tub water. TEMPERATURE LOCK is a submenu of the TOOLS menu

To activate the TEMPERATURE LOCK, press the MODE ▲ button in the TOOLS submenu until the LOCK + symbol is illuminated on the display. The lock icon will flash on and off when deactivated. Press the ON ▲ button to activate the TEMPERATURE LOCK feature.

When the TEMPERATURE LOCK is activated, the JETS, LIGHT and any other features your hot tub may have will operate normally, and the temperature setting can be viewed but can NOT be changed. If a temperature button is pressed, the control panel will display the lock symbol and the set temperature for 30 seconds, then turn off.

To deactivate the TEMPERATURE LOCK, press the MODE ▲ button in the TOOLS submenu until the LOCK - symbol is illuminated on the display. Press the OFF ▼ button to deactivate the TEMPERATURE LOCK feature.

Temp Lock Display

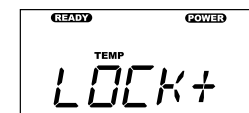

Temp Locked Display

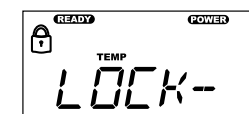

SPA LOCK

The SPA LOCK feature deactivates all of the functions of the control panel. It is generally used to prevent unwanted use of the spa. The SPA LOCK menu is a submenu of the TOOLS menu.

To activate the SPA LOCK, press the MODE ▲ button in the TOOLS submenu until the SPA + symbol is illuminated on the display. The lock icon will flash on and off when deactivated. Press the ON ▲ button to activate the SPA LOCK feature.

Spa Lock Display

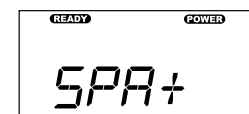

NOTE: When Hot tub is locked, any display other than SPA having a - or + after it will be replaced with an * after the word indicating the function is locked out. The * will only go away after the Spa is unlocked.

When the SPA LOCK is activated, the buttons for the jets, temperature control, light, and any other features your hot tub may have are deactivated. If a button is pressed, the control panel will display the lock symbol and the word SPA for 30 seconds, then turn off.

To deactivate the SPA LOCK, press the MODE ▲ button in the TOOLS submenu until the SPA - symbol is illuminated on the display. Press the OFF ▼ button to deactivate the SPA LOCK feature.

Spa Locked Display

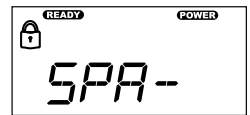

LOCK OVERRIDE

The Lock Override feature is for hot tub users who normally keep the set temperature locked. Should the user wish to lock all hot tub controls temporarily, the hot tub lock can be applied over an already-applied temperature lock. Then, when the spa lock is removed, the temperature lock will remain on to prevent unwanted tampering with the set temperature.

SUMMER MODE

Your LIMEIGHT® hot tub is equipped with a Summer Mode timer. The Summer Mode timer can be activated during extremely hot summer months if it becomes difficult to maintain water temperatures low enough for comfort. Upon switching to the ON mode, the circulation pump (which can add heat to the water through normal operation) and heater will immediately shut down for the next eight hours. Additionally, the summer mode display on the control panel will activate and remain active for as long as the summer mode is on. Following this eight hour period, the circulation pump and heater will automatically re-start and will operate normally for the next sixteen hours. The circulation pump and heater will continue to turn off for an eight hour period every day that the timer remains in the ON position. In this way, the amount of heat transferred to the hot tub water will be minimized. When the outside temperatures begin to cool, the Summer Mode timer should be turned to the OFF position (the summer mode icon on the main display will shut off). This is the efficient 24 hour circulation mode that keeps the heater operation and operating costs to a minimum during colder/heavier usage months.

NOTE: Whenever power is disconnected and then reconnected to the hot tub, the Summer Mode timer will reset starting with the 8-hour shutdown mode. If a different 8-hour shut down time is desired, deactivate the Summer Mode, then reactivate at the beginning of the desired eight-hour shut down time.

IMPORTANT: The Summer Mode will not lower the hot tub's water temperature below the ambient air temperature.

To activate the Summer Mode, simply follow these steps:

1. Set the temperature control to 80°F (26°C) if desired to prevent the heater from turning on during cooler times.
2. On the control panel press the MODE ▼ button until the TOOLS menu is illustrated. Then press the ON ▲ button to enter the TOOLS submenus. Press the MODE ▼ button until the STMR+ symbol is illuminated on the display. Press the ON ▲ button to activate the Summer Timer mode.

The Summer Mode must be deactivated when cooler temperatures return. To do this, simply follow step 3.

3. To shut the Summer Mode off, press the MODE ▼ button until the TOOLS menu is illustrated. Then press the ON ▲ button to enter the TOOLS submenus. Press the MODE ▼ button until the STMR- symbol is illuminated on the display. Press the OFF ▼ button to deactivate.

Summer Mode Display

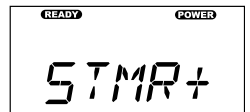

Summer Timer ON Display



MUSIC CONTROL

The following applies to LIMEIGHT hot tubs that have an optional music system installed:

When the wireless music system has been installed on the spa, the control panel can be used to control the music system. The following information demonstrates how to navigate the music menu by using the spa's control panel.

MUSIC MENU

Once the music system is installed, a MUSIC menu will be accessible on the control panel screen.

To access the menu, press the MODE ▲ or MODE ▼ buttons on the control panel until MUSIC is displayed.

BASIC CONTROL PANEL OPERATION

- To enter into a sub-menu, or to adjust the current function displayed, use the ON ▲ or OFF ▼ buttons.
- To move to the next sub-menu use the MODE ▲ or MODE ▼ buttons.
- To exit from any sub-menu, press MODE ▲ as many times as necessary until EXIT is displayed then press ON▲ button to exit that sub-menu.

TO TURN MUSIC SYSTEM ON/OFF

From the MUSIC menu:

1. Press the ON ▲ button to display AUDIO.

2. Press the ON ▲ button to display PWR.
3. Press the ON ▲ button to display PWR + and turn the music system ON. Press the OFF ▼ button to display PWR - and turn the music system OFF.

IMPORTANT: The power can take up to 10 seconds to turn on or off.

TO ADJUST VOLUME

From the MUSIC menu:

1. Press the ON ▲ button to display AUDIO.
2. Press the ON ▲ button to display PWR.
3. Press the MODE ▲ button to display VOL.
4. Press the ON ▲ button to increase volume and the OFF ▼ button to decrease volume.

NOTE: Volume range is from 1-40. No number displayed indicates Volume is OFF.

TO ADJUST EQ

From the MUSIC menu:

1. Press the ON ▲ button to display AUDIO.
2. Press the ON ▲ button to display PWR.
3. Press the MODE ▲ to display VOL.
4. Press the MODE ▲ to display SETUP.
5. Press the ON ▲ button to display EQ.
6. Press the ON ▲ button for EQ +. Press OFF ▼ button for EQ -.

Equalizer Boost - EQ + for boost, EQ - for no boost.

TO ADJUST SOURCE

From the MUSIC menu:

1. Press the ON ▲ button to display AUDIO.
2. Press the ON ▲ button to display PWR.
3. Press the MODE ▲ to display VOL.
4. Press the MODE ▲ to display SETUP.
5. Press the ON ▲ button to display EQ.
6. Press MODE ▲ to display SRC.
7. Press either ON ▲ or OFF ▼ button to change the SRC number.

IMPORTANT: Source Screen - SRC number must be on 3 for music system to function.

TO PAUSE/PLAY IPOD®

From the MUSIC menu:

1. Press the ON ▲ button to display AUDIO.
2. Press the MODE ▲ to display ICAST™.
3. Press the ON ▲ button for PLAY+.
4. Press ON ▲ button to start or stop the iPod.

TO CHANGE TRACK ON IPOD

From the MUSIC menu:

1. Press the ON ▲ button to display AUDIO.
2. Press the MODE ▲ to display ICAST.
3. Press the ON ▲ button to display PLAY+.
4. Press the MODE ▲ to display TRK +.
5. Press either ON ▲ or OFF ▼ button to change the iPod track.

TO EXIT ICAST™ MENU

From the ICAST menu:

1. Press the MODE ▲ as many times as necessary until EXIT is displayed.
2. Press the ON ▲ button to exit music system.

NOTE: The last Volume and EQ settings used prior to powering down the music system will be the new default settings used the next time the music system powers up.

DISPLAY INVERSION

You may invert the control panel display for easier viewing from inside the hot tub.

To invert the display the following is required:

Press the "MODE ▼" & "OFF ▼" buttons simultaneously. By pressing the "MODE ▼" & "OFF ▼" buttons simultaneously a second time the screen will go back to it's original display.

HOT TUB CARE AND MAINTENANCE

Your Limelight® hot tub is manufactured from the highest quality, most durable materials available. Even so, the hot tub care and maintenance program you develop will ultimately determine how long your hot tub, and its individual components, will last. Regular maintenance and following the advice in this section will help you to protect your investment.

DRAINING THE WATER

Detergent residues from bathing suits and soap film from your body may gradually accumulate in your hot tub's water. Normally, in about four months the water will become sudsy and should be replaced. Showering without using soap prior to entering the hot tub, and using only the rinse cycle when laundering your bathing suit, will help to reduce detergent residue in the hot tub water. **IMPORTANT:** Remember to change your water every three to four months.

TO DRAIN YOUR HOT TUB:

1. Disconnect the spa from the power supply by tripping both of the GFCI breakers located in the subpanel.
2. Locate the drain valve for the hot tub and remove the drain cap. Attach the inlet of a garden hose to the drain valve (to avoid flooding of the foundation surrounding the hot tub) and route the outlet of the hose to an appropriate draining area.

NOTE: Hot tub water with a high sanitizer level may harm plants and grass.

3. Open the valve by turning the knob. The hot tub will drain by gravitational flow.

IMPORTANT: All Limelight hot tub models will drain almost completely through the main drain valve. Equipment such as the jet pump and heating system will drain. Any water remaining within the plumbing or equipment after draining will only need to be removed if the hot tub is being winterized.

4. Allow all of the water to drain through the drain.
5. When empty, inspect the hot tub shell and clean as required. (Follow the Care of the Exterior Finish instructions.)
6. Close the drain valve and reinstall the drain cap.
7. Refill the hot tub through the filter compartment BEFORE restoring power.

PREVENTION OF FREEZING

Your spa has been designed and engineered for year-round use in any climate. In some areas, extremely cold temperatures (below 10°F) combined with strong wind, may cause partial freezing of the jet pump, even though the water inside the spa remains at the selected temperature. The energy efficiency of the spa may also decrease during these cold periods, as the heater will cycle more frequently. As an additional precaution against partial freezing of some of the components, the equipment compartment can be insulated with an insulating kit (available from your local dealer). This insulating kit will also help to maximize the spa's energy efficiency.

NOTE: When warmer weather returns (approx. 60°-70°F), the insulating kit must be removed to prevent overheating of the jet pump.

WINTERIZING YOUR SPA

If you leave the spa unused for a long period of time in severely cold weather, you should drain the spa and winterize it to avoid accidental freezing due to a power or equipment failure.

DANGER: Use only Propylene Glycol as your anti-freeze (available at most RV or marine supply stores). This is non-toxic. Never use an automobile anti-freeze (Ethylene Glycol) since it is toxic!

WARNING: Failure to follow these instructions correctly can lead to freeze damage not covered by warranty. It is strongly recommended that you contact your local dealer to perform this service

1. Drain your spa following the Draining Your Spa section in the owner's manual.
2. Remove the filter cartridge, clean and store in a dry place.

IMPORTANT: These additional instructions must be utilized when draining and winterizing your spa in climates where the temperature falls below 32°F (0°C). A five (5) gallon combination (vacuum/blower) wet/dry shop vac must be used to effectively remove water that is trapped inside the plumbing lines.

3. Attach the vacuum's hose to the blower side of the shop vac.
 - a) Place the end of the vacuum hose down the filter opening.
 - b) Turn on the blower function and allow it to blow out any water remaining in the plumbing lines (approximately 3 to 5 minutes).
 - c) Turn the SmartJet® lever to the second position and allow that system to purge.
 - d) If your spa is equipped with more than two jet systems, then each jet system will also need to be blown out.
4. Attach the vacuum hose to the vacuum side of the shop vac. Vacuum all openings and orifices as follows:
 - a) Jet openings: start with the jets at the top and move downward (if suction is coming from another jet, block off the other jet using a large rag – this will help pull out the water that is trapped deeper inside the main line).
 - b) Filter suction fittings and filter compartment.
 - c) Main drain outlet (it may be necessary to cover the drain grate tightly with a rag when vacuuming the main drain to ensure water is drawn completely from the internal plumbing system).
5. Thoroughly dry the spa shell with a clean towel.
6. Replace the main drain cap.

CAUTION: Use only Propylene Glycol as your anti-freeze. This is non-toxic. Never use an automobile anti-freeze (Ethylene Glycol) since it is toxic!

7. Using a long-extension funnel, pour anti-freeze into all standpipes, filter suction fittings, jet orifices and water feature orifices. Add enough anti-freeze to ensure adequate protection – in many cases, you will see the liquid in the orifice, or coming out of another location.
8. Close the spa cover and fasten the cover tie downs. Cover the spa cover with two pieces of plywood to evenly distribute the weight of snow and ice. Secure a plastic sheet, or tarp, over the spa cover and plywood.
9. Replace the equipment access door, if removed.

OPENING INSTRUCTIONS:

1. Remove plywood and plastic sheet. Open the spa cover by unfastening the cover tie downs.
2. Follow the Start-up and Refill Procedures in the Operating Instructions section of the Owner's Manual. Do not install filters to prevent them from exposure to the anti-freeze.
3. As part of this process, superchlorinate the spa water by adding three teaspoons of chlorine (sodium dichlor) per 250 gallons of spa water into the filter compartment. This is twice the normal amount of chlorine needed for superchlorination. This extra amount of chlorine is needed to destroy the anti-freeze.

NOTE: A defoamer may be needed to decrease the amount of foam caused by the anti-freeze.

4. Drain your spa to ensure removal of anti-freeze. Do not drain water on grass or plants due to excessive chlorine level.
5. After the spa has completely drained, re-install your filter and follow the Start-up and Refill Procedures in the Operating Instructions section of the Owner's Manual.

IMPORTANT: Always keep spa covered when not in use, whether it is empty or full.

FILTER SYSTEM

The filter lid on the hot tub is NOT designed to support heavy weight loads and should not be used as a seat. In extreme cases, the lid could crack and break. This occurrence is considered abuse and is not covered under the warranty.

Limelight hot tubs are equipped with one filter cartridge, sized to meet the needs of the jet pump system.

As with any water filtering system, the filter cartridge may become clogged, resulting in reduced water flow. It is important to maintain a clean, unobstructed filtering system. This not only provides the maximum performance from the jets, but allows the 24 hour filtration system to function effectively. *Watkins Manufacturing Corporation recommends the filter cartridge be cleaned (by soaking in a filter cleaner to dissolve minerals) at least once every month.*

⚠ **WARNING:** The frequency and duration of use, and the number of occupants, all contribute to determining the appropriate time between filter cleanings. More use means that more frequent filter cleanings are required. Failure to maintain the cartridge in a clean, unobstructed manner will result in reduced water flow through the heater assembly that may cause the High Limit Thermostat, Heater Thermal Cut-off or Circulation Pump freeze. Any damage to the hot tub (due to freezing) caused as a result of poor maintenance (stated under misuse or abuse in the Limelight hot tub Limited Warranty), will not be covered by your hot tub warranty.

DANGER: To reduce the risk of injury to persons using the hot tub, DO NOT remove the suction fittings or filter standpipe (located in the filter compartment).

SECONDARY SUCTION SCREEN

Located in the footwell of your hot tub are three secondary suction screens. The screen is used as a filter to prevent dirt from circulating through the system.

⚠ **WARNING:** Do not use the hot tub with the suction screens removed.

FILTER CARTRIDGE REMOVAL & CLEANING

1. Disconnect the hot tub from the power supply by tripping both of the GFCI breakers located in the subpanel.
2. Remove and carefully set aside the filter compartment cover.
3. Remove any floating items from within the filter compartment.
4. Turn the filter retainer handle (located on the top of the filter cartridge) counterclockwise until the retainer can be removed from the filter standpipe.
5. Remove the filter retainer and cartridge.

SERVICE NOTE: Never remove the filter standpipe when debris is present in the filter compartment. Debris may find its way into the internal plumbing which may result in blockage. NEVER REMOVE SUCTION FITTINGS!

6. Always clean the filter using a filter degreaser, such as Hot Spring® FreshWater® Filter Cleaner, to remove mineral and oil build-up. Simply soak the filter in the degreaser according to the package directions, then place the filter on a clean surface and spray until clean using a garden hose. It may be necessary to rotate the filter while spraying to remove any debris lodged between the filter pleats.
7. To reinstall the filter cartridge, reverse the order of steps in which it was removed. Do not overtighten

⚠ **WARNING:** Do not use the hot tub with the filter cartridge(s), or filter standpipe(s) removed!

CARE OF THE HOT TUB PILLOWS

The pillows used in your Limelight™ hot tub will continue to provide comfort if treated with care. They have been positioned above the water level to minimize the bleaching effects of chlorinated water, and other hot tub water chemicals. To extend their life, whenever the hot tub shell is being cleaned, the hot tub pillows should be removed and cleaned. Body oils can be removed with a mild soap and water solution. ALWAYS rinse off the hot tub pillows thoroughly to remove any soap residue. The pillows can be conditioned with Hot Spring Cover Shield after cleaning. If the hot tub is not going to be used for a long period of time (that is during a vacation, or if the hot tub is winterized), or when the hot tub water is being super-chlorinated, the hot tub pillows should be removed until the next hot tub use. Periodic replacement of the hot tub pillows will be necessary in order to maintain the new look of your hot tub.

TO REMOVE AND REPLACE THE HOT TUB PILLOWS:

1. Carefully pull and lift on one end of pillow to stretch pillow (longer) until the pillow is released from the plastic retainer. Once one end is released, push pillow in opposite direction to remove from other retainer.
2. Align pillow.
3. Slide one end of pillow onto the spa retainer.
4. Pull other end of pillow; using both hands lift pillow above retainer and with a stretching motion slide pillow recess onto retainer.

CARE OF THE EXTERIOR

HOT TUB SHELL

Your Limelight hot tub has an acrylic shell. Stains and dirt generally will not adhere to your hot tub's surface. A soft rag or a nylon scrubber should easily remove most dirt. Most household chemicals are harmful to your spa's shell. Watkins Manufacturing Corporation recommends Hot Spring FreshWater® Spa Shine. Cleaning of the surface should only be done with a non-abrasive, non-sudsing cleaner. Sodium bicarbonate (baking soda) can also be used for minor surface cleaning. A soft rag or a nylon scrubber should easily remove most dirt. Always thoroughly rinse off any spa shell cleaning agent with fresh water.

SERVICE NOTES:

1. Iron and copper in the water can stain the hot tub shell if allowed to go unchecked. Ask your Limelight® dealer about a Stain and Scale Inhibitor such as Hot Spring® FreshWater® Stain and Scale Defense to use if your hot tub water has a high concentration of dissolved minerals.

2. The use of alcohol or any household cleaners other than those listed to clean the hot tub shell surface is NOT recommended. DO NOT use any cleaning products containing abrasives or solvents since they may damage the shell surface. **NEVER USE HARSH CHEMICALS!** Damage to the shell by the use of harsh chemicals is not covered under the warranty.

IMPORTANT: Some surface cleaners contain eye and skin irritants. Keep all cleaners out of the reach of children and use care when applying.

ELMWOOD™ HOT TUB CABINET

Limelight hot tubs include an ELMwood hot tub cabinet. ELMwood consists of a rigid polymer that combines the durability of plastic, with the beauty of wood. ELMwood won't crack, peel, blister, or delaminate even after prolonged exposure to the elements.

Cleaning of ELMwood consists of simply spraying the cabinet with a mild soap and water solution to remove any stains and residue.

Do not rub the ELMwood with an abrasive material or use abrasive cleaners, as this may damage its texture.

Watkins Manufacturing Corporation recommends touch-up or restaining of the ELMwood every three to four years (this will vary according to the environment). Contact your local dealer for restaining procedures and recommended stains.

CARE OF THE HOT TUB COVER

⚠ **WARNING:** The vinyl cover is a manual safety cover that meets or exceeds all prevailing requirements of ASTM Standards for hot tub safety covers when installed and used correctly as of the date of manufacture. Non-secured, or improperly secured covers are a hazard. Open the cover to its fully open position before use.

VINYL COVER

The vinyl hot tub cover is an attractive, durable foam insulation product. Monthly cleaning and conditioning are recommended to maintain its beauty.

TO CLEAN AND CONDITION THE VINYL COVER:

1. Remove the cover from the hot tub and gently lean it against a wall or fence.
2. With a garden hose, spray the cover to loosen and rinse away dirt or debris.
3. Using a large sponge and/or a soft bristle brush, and using a very mild soap solution (one teaspoon dishwashing liquid with two gallons of water), or baking soda (sodium bicarbonate), scrub the vinyl top in a circular motion. Do not let the vinyl dry with a soap film on it before it can be rinsed clean.

IMPORTANT: To avoid soap getting into the hot tub water, the hot tub cover should not be on the hot tub during cleaning.

4. Scrub the cover's perimeter and side flaps. Rinse clean with water.
5. Rinse off the underside of the cover with water only (use no soap), and wipe it clean with a dry rag.
6. To condition the cover after cleaning, apply a thin film of Hot Spring Cover Shield to the vinyl surface and buff to a high luster.

SERVICE NOTE: To remove tree sap, use cigarette lighter fluid (not charcoal lighter fluid). Use sparingly, and rinse with saddle soap solution immediately afterwards, then wipe dry.

Important reminders:

- **DO** remove snow buildup to avoid breakage of the foam core from the additional weight of the snow.
- **DO** lock cover straps to secure the cover when the hot tub is not in use.
- **DO NOT** drag or lift the hot tub cover using either the flaps, or the tie-down straps.
- **DO NOT** walk, stand, or sit on the cover.
- **DO NOT** place any metal or heat transferring object on the cover or place any type of plastic tarp or drop cloth over the cover as this may result in a melted foam core, which would not be covered under the warranty.
- **DO NOT** use any lifting mechanisms, chemicals, or cleaners except those recommended by Watkins Manufacturing Corporation, or its Authorized Sales and Service Dealer.

IMPORTANT: Whenever the hot tub is not in use, it is essential that the cover be in place. When filled, this ensures effective temperature maintenance and economical operation. When empty, this prevents potential damage to the surface finish of the interior walls, which can result from the excessive heat of the sun. This type of damage is specifically excluded from warranty coverage.

RETRACTABLE COVER SYSTEM

Clearance required behind cover when open: • CoverCradle® & CoverCradle II - 24" • UpRite® - 7" • Lift 'n Glide® - 14"

IMPORTANT: Use of a cover lifter other than those listed above will void the Limelight Hot Tub cabinet warranty. Cover lifters must be installed to open back-to-front. Installing a cover lifter to open Side-to-Side will void the limelight Hot Tub cabinet warranty. See Limitations Section of the Limelight Hot Tub warranty.

HOW TO OPEN THE VINYL COVER

NOTE: Never attempt to open or remove the vinyl cover by grasping or pulling on the skirting or cover lock straps. The skirting will tear, and torn

skirting is not covered under the terms of the warranty.

Check for ice build-up around the gas springs and pivot points of the retractable cover system. Ice buildup may damage system components.

⚠ WARNING: The vinyl cover and retractable cover system are not recommended for use in wind conditions reaching above 25 mph (40kmh).

NOTE: If your hot tub is located in an area susceptible to high winds, additional cover lock straps may be installed to minimize wind damage to the cover.

HOW TO OPEN THE COVER

1. With the cover lock straps unfastened, place one hand under the cover skirting, between the hot tub and cover, to break the cover's vacuum seal. Then, fold the front half of the cover over onto the back half.
2. If no rear access is available, stand to the side of the hot tub directly adjacent to the hinge area of the folded cover.
 - A. **For the CoverCradle® & CoverCradle II retractable cover systems:** Using both hands, cup one hand under the lower half of the cover (just above the water) and place the other along the side of the cover, just above the skirt. Gently push (do not lift) with both hands towards the opposite rear corner of the cover (diagonally). As the cover opens, the gas springs will allow the cover to come to a gentle stop.
 - B. **For the UpRite® retractable cover systems:** Simply lift the cover at its center hinge, allowing it to move to the back of the hot tub and to gently rest there.
 - C. **For the Lift 'n Glide® retractable cover system:** Slightly lift the cover at front of hot tub, glide (push back till it stops), fold cover in half and lift cover moving it to the back of the hot tub. Insert locking pin into side of lifter to prevent accidental closure.

NOTE: When opening a cover with a retractable cover system, only use one of these three specific methods. Do not attempt to open the cover in any other way. Damage caused by improper opening or closing of the cover is not covered under the terms of the limited warranty.

HOW TO CLOSE THE COVER

1. Standing along side the cover, place one hand on the upper corner of the cover and gently push forward in the direction of the hot tub. The cover will rotate forward to cover half of the hot tub.

NOTE: For the UpRite or Lift 'n Glide retractable cover system, disengage the locking mechanism(s) before pushing the cover forward.
2. Unfold the cover by lifting the handle located on the top (front) half of the cover. Allow the unfolded half to fall down onto the hot tub. The air pressure created by the cover falling will keep the vinyl skirting from being trapped between the cover and the hot tub shell.
3. Secure the cover lock straps to the hot tub and lock them.

IMPORTANT REMINDERS:

- **DO** always practice safety around your hot tub.
- **DO** unlock and release all cover locks before attempting to open cover.
- **DO** lock the cover when the hot tub is not in use.
- **DO** cover the hot tub with the vinyl cover when the hot tub is not in use, whether it is empty or full.
- **DO** remove snow build-up to prevent vinyl cover damage.
- **DO** keep the cover open during super-chlorination or shock treatment of the hot tub water.
- **DO NOT** walk, stand, climb, or sit on the vinyl cover or retractable cover system.
- **DO NOT** lift the cover or operate the retractable cover system by using the cover locks. They are not designed to be used as handles.
- **DO NOT** use any chemicals or cleaners except those recommended by Watkins Manufacturing Corporation, or its Authorized Sales and Service Dealer.
- **DO NOT** use hard, sharp, or metal objects, such as a car windshield scraper, to remove ice. Such objects can cut, mar, or puncture the vinyl surfaces.

⚠ WARNING: Keep unsupervised children away from the cover. Always lock the cover in place after use! Keep hands away from the hinging points. Do not allow anyone to climb, sit, or stand on the cover when in the open position. Injury may occur, as well as damage to the cover and mechanism.

VACATION CARE INSTRUCTIONS

If you plan to be away from home, follow these instructions to ensure that the water quality of your hot tub is maintained:

SHORT TIME PERIODS (3-5 DAYS):

1. Adjust the pH by following the instructions outlined in the Water Quality and Maintenance section.
2. Sanitize the water by following the shock procedures also listed in the Water Quality section.
3. Lock your cover in place using the cover lock straps.
4. Upon your return, sanitize the water by following the shock procedures, and balance the pH.

LONG TIME PERIODS (5-14 DAYS):

PRIOR TO LEAVING:

1. At least one day before you leave, set the temperature to its lowest level. This setting should be 80°F (26°C).

IMPORTANT NOTE: Hot tub water oxidizers such as sodium dichlor (chlorine) maintain their level of effectiveness substantially longer in warm water (80°F, or 26°C) than in hot water (101°F to 104°F, or 38°C to 40°C).

2. Adjust the pH as required. Sanitize the water by following the shock procedures.

UPON YOUR RETURN:

3. Sanitize the water by following the shock procedures. Return the set temperature to its original setting. The hot tub water will be safe for you to use once the Free Chlorine Residual level has dropped below 5.0 ppm.

NOTE: If you will not be using your hot tub for an extended period of time (in excess of 14 days) and an outside maintenance service (or neighbor) is not available to assist with the water maintenance, draining or winterizing of the hot tub is recommended. Hot tubs equipped with our FreshWater® III ozone system can extend this to 4 weeks. The FreshWater III ozone system does not guard against possible freezing damage, however.

WATER QUALITY AND MAINTENANCE

IMPORTANT: Always keep hot tub covered when not in use (whether it is empty or full).

It's important to have clean water. Water maintenance is one of the most important areas of hot tub ownership. Your dealer can guide you through the process of achieving and maintaining perfect water in your hot tub, given your local conditions; here is our suggested step-by-step program.

IMPORTANT: See "Water Terminology" section found later in this chapter to help you better understand chemical terms.

Your program will depend on your water's mineral content, how often you use your hot tub, and how many people use it.

Watkins has developed the EverFresh® water care system for its hot tubs, which is an alternative to using an entirely chlorine-based system. This system uses silver ions, ozone, and an oxidizer (monopersulfate or MPS) and dichlor to sanitize the hot tub. It includes the FreshStart®_{10,000} pre-filter, the FreshWater® III high output ozone system, and the FreshWater_{Ag+}® silver ion purifier.

GENERAL INFORMATION

THE THREE FUNDAMENTAL AREAS OF WATER MAINTENANCE:

- Water Filtration
- Chemical Balance/pH Control
- Water Sanitation

Water sanitation is the responsibility of the hot tub owner, achieved through the regular and periodic (daily, if necessary) addition of an approved sanitizer. The sanitizer will chemically control the bacteria and viruses present in the fill water or introduced during use of the hot tub. Bacteria and viruses can grow quickly in undersanitized hot tub water.

The water's chemical balance and pH control are also the responsibility of the hot tub owner. You will have to add chemicals to maintain proper levels of Total Alkalinity (TA), Calcium Hardness (CH) and pH. Proper water balance and pH control will minimize scale buildup and metal corrosion, extend the life of the hot tub, and allow the sanitizer to work at maximum efficiency.

METHODS FOR TESTING THE HOT TUB WATER

Accurate water testing and analysis are important parts of effectively maintaining your hot tub water. You must have the ability to test for:

- Total Alkalinity (TA)
- pH
- Calcium Hardness (CH)
- Sanitizer

Two types of testing methods are recognized and recommended by Watkins:

The Reagent Test Kit is a method which provides a high level of accuracy.

Test Strips are a convenient testing method used by many hot tub owners. Keep in mind that test strips are susceptible to heat and moisture contamination, which will result in inaccurate readings.

IMPORTANT: Always read and carefully follow the directions included with the Test Kit or Test Strips to ensure the accuracy of the test results.

BASIC CHEMICAL SAFETY

When using chemicals, read the labels carefully and follow directions precisely. Though chemicals protect you and your hot tub when used correctly, they can be hazardous in concentrated form. Always observe the following guidelines:

- Allow only a responsible person to handle hot tub chemicals. **KEEP THEM OUT OF THE REACH OF CHILDREN AND PETS.**

- Accurately measure the exact quantities specified, never more. Do not overdose your hot tub.
- Handle all containers with care. Store in a cool, dry, well ventilated place.
- Always keep chemical containers closed when not in use. Replace caps on their proper containers.
- Don't inhale fumes, or allow chemicals to come in contact with your eyes, nose, or mouth. Wash your hands immediately after use.
- Follow the emergency advice on the product label in case of accidental contact, or if the chemical is swallowed. Call a doctor or the local Poison Control Center. If a doctor is needed, take the product container along with you so that the substance can be identified.
- Don't let chemicals get on surrounding surfaces or landscaping. Don't use a vacuum cleaner to clean up chemical spills.
- Never smoke around chemicals. Some fumes can be highly flammable.
- Don't store any chemicals in the hot tub equipment compartment.

HOW TO ADD CHEMICALS TO THE WATER

IMPORTANT: All hot tub water chemicals, including granulated dichlor, MPS, granulated pH increaser or decreaser, granulated total alkalinity increaser, calcium hardness increaser, liquid stain and scale inhibitor, and liquid defoamer must always be added directly into the filter compartment while the jet pump is running in high speed mode, and it must run for a minimum of ten minutes.

TO ADMINISTER HOT TUB WATER CHEMICALS:

1. Fold back the cover. Carefully remove and set aside the filter compartment cover.
2. Push the JETS button to turn on the jet pump.
3. Carefully measure the recommended amount of chemical and slowly pour it into the filter compartment. Use care not to splash chemicals on your hands, in your eyes, on the hot tub shell surface, or on the cabinet.
4. After ten minutes, turn the jet pump off, and close and secure the cover to complete the procedure.

Risk of Drowning: Never leave an open hot tub unattended!

IMPORTANT "SUPER CHLORINATION/NON-CHLORINE SHOCK TREATMENT" NOTE: After administering a super chlorination treatment or non-chlorine shock to your hot tub, leave the cover open for a minimum of 20 minutes to allow the oxidizer gas to vent. A high concentration of trapped oxidizer gas which may exist as a result of the shock treatment (not daily sanitation) may eventually cause discoloration or vinyl degradation to the bottom of the cover. This type of damage is considered chemical abuse and is not covered under the terms of the limited warranty.

⚠ **WARNING:** High sanitizer levels can cause discomfort to the user's eyes, lungs, and skin. Always allow the sanitizer level to fall to the recommended range before using the hot tub.

THE LIMELIGHT® HOT TUB WATER MAINTENANCE PROGRAM

Each step in your water maintenance program is dependent on the completion of the previous steps. Omitting a step, or failing to reach the recommended range may cause an imbalance in your water chemistry. Unbalanced water chemistry can damage the hot tub, and its components, as well as cause discomfort for the user.

FILLING THE HOT TUB WITH WATER

- A. Watkins Manufacturing Corporation recommends using the FreshStart[®]_{10,000} pre-filter when filling the hot tub (through the filter compartment) with water.

⚠ **WARNING:** DO NOT use the FreshStart_{10,000} pre-filter if you plan to use bromine or BaquaSpa™ as your sanitizer.

- B. The FreshStart_{10,000} pre-filter is designed to remove unwanted contaminants such as rust, dirt, detergents, and algae from the fill water. Dissolved minerals and metals such as lead, calcium, copper, and iron are not removed.
- C. Instructions are included with the FreshStart_{10,000} pre-filter. When the hot tub is filled, proceed to the next step.

BALANCING THE TOTAL ALKALINITY (TA)

- A. The recommended Total Alkalinity (TA) for your hot tub water is 40-120 ppm.
- B. Total Alkalinity is a measure of the total levels of carbonates, bicarbonates, hydroxides, and other alkaline substances in the water. TA is referred to as the water's "pH buffer". In other words, it's a measure of the ability of the water to resist changes in pH level.
- C. If the TA is too low, the pH level will fluctuate widely from high to low. Fluctuations in pH can cause corrosion or scaling of the hot tub components. **Low TA can be corrected by adding Hot Spring® FreshWater® pH/Alkalinity Up, or sodium hydrogen carbonate.**
- D. If the Total Alkalinity is too high, the pH level will tend to be high and may be difficult to bring down. **It can be lowered by adding Hot Spring FreshWater pH/Alkalinity Down, or sodium bisulfate.**

| | | |
|---|-----|---------------------------------------|
| ALKALINE HOT TUB WATER (SCALING ZONE) | 8.2 | ADD pH DECREASER TO LOWER pH |
| | 7.8 | |
| | 7.6 | |
| COMFORT ZONE | 7.4 | IDEAL |
| ACIDIC HOT TUB WATER (CORROSIVE ZONE) | 7.2 | ADD pH INCREASER TO RAISE pH |
| | 6.8 | |
| | pH | |

- E. Once the TA is balanced, it normally remains stable, although the addition of more water with a high or low alkalinity will raise or lower the TA reading of the water.
- F. When the Total Alkalinity is within the recommended range, proceed to the next step.

BALANCING THE CALCIUM HARDNESS (CH)

- A. The recommended Calcium Hardness (CH) level for your hot tub is 100-150 ppm.
- B. Calcium Hardness is a measure of the total amount of dissolved calcium in the water. Calcium helps control the corrosive nature of the hot tub's water. That's why calcium-low water (commonly known as "soft" water) is not recommended. It is very corrosive to the equipment, and can cause staining of the hot tub shell.
- C. If the CH is too high (commonly known as "hard" water), formation of scale on the hot tub's shell surface and equipment can result. **CH can be decreased by dilution – a mixture of 75% hard and 25% soft water will be a good starting point.** If soft water is not available, or practical for you, a stain and scale control such as Hot Spring FreshWater® Stain and Scale Defense should be added to the hot tub water, according to instructions on its label.
- D. Once the CH is balanced, it normally remains stable, although the addition of more water with a high or low calcium content will raise or lower the CH reading of the water.
- E. When the Calcium Hardness is within the recommended range, proceed to the next step.

BALANCING THE pH

- A. The ideal pH level for your hot tub water is 7.4-7.6.
- B. The pH level is the measure of acidity and alkalinity. Values above 7 are alkaline; those below 7 are acidic. Maintaining the proper pH level is extremely important for:
- Optimizing the effectiveness of the sanitizer.
 - Maintaining water that is comfortable for the user.
 - Preventing equipment deterioration.
- C. If the hot tub water's pH level is too low, the following may result:
- The sanitizer will dissipate rapidly.
 - The water may become irritating to hot tub users.
 - The hot tub's equipment may corrode.

If the pH is too low, it can be increased by adding Hot Spring FreshWater pH/Alkalinity Up, or sodium hydrogen carbonate to the hot tub water.

- D. If the pH level is too high, the following may result:
- The sanitizer is less effective.
 - Scale will form on the hot tub shell surface and the equipment.
 - The water may become cloudy.
 - The filter cartridge pores may become obstructed.

If the pH is too high, it can be decreased by adding Hot Spring FreshWater pH/Alkalinity Down, or sodium bisulfate to the hot tub water.

NOTE: After adding sodium hydrogen carbonate or sodium bisulfate, **wait two hours** before testing the water for pH. Measurements taken too soon may not be accurate.

- E. It is important to check the pH on a regular basis. The pH will be affected by the bather load, the addition of new water, the addition of various chemicals, and the type of sanitizer used.
- F. When the pH is within the recommended range, proceed to the final step.

MAINTAINING THE SANITIZER LEVEL

- A. Sanitizer is extremely important for killing algae, bacteria and viruses, and preventing unwanted organisms from growing in the hot tub. At the same time, you don't want too high a sanitizer level, or it can irritate your skin, lungs, and eyes.
- B. Always maintain the sanitizer level in your hot tub at the recommended level for each type of sanitizer.
- C. Watkins recommends only the following sanitizers:
- Sodium Dichloro-s-Triazinetrione (sodium dichlor or chlorine)
 - Brominating Concentrate™ (one step granular bromine)
 - BaquaSpa® (please consult your BaquaSpa manual for instructions on the use of this product).

THE WATKINS WATER MAINTENANCE QUICK REFERENCE GUIDE

| Steps | Ideal Range (ppm) | | What Chemicals to Use | |
|--------------------|--|------|--|---|
| | Min. | Max. | To Raise | To Lower |
| 1 Total Alkalinity | 40 | 120 | Hot Spring® FreshWater® (Sodium Hydrogen Carbonate, or Sodium Bicarbonate) | Hot Spring FreshWater (Sodium Bisulfate) |
| 2 Calcium Hardness | 100 | 150 | Hot Spring FreshWater Calcium Hardness Increaser | Use a mixture of 75% hard water and 25% soft water or use a Stain and Scale Inhibitor |
| 3 pH | 7.4 | 7.6 | | Sodium Bisulfate |
| 4 Sanitizer | See section on Maintaining the Sanitizer Level | | | |

⚠ **WARNING:** DO NOT use tri-chlor chlorine, bromo-chloro-dimethyl-hydantoin (BCDMH), or any type of compressed bromine or chlorine, acid or any type of sanitizer which is not recommended by Watkins Manufacturing Corporation.

EVERFRESH® WATER CARE SYSTEM

The EverFresh water care system is comprised of the following products:

- FreshStart[®]_{10,000} Pre-filter
- Sodium dichlor
- Monopersulfate (MPS)
- FreshWater[®] III high output ozone system
- FreshWater_{Ag+}[®] silver ion purifier

FreshStart_{10,000} Pre-filter is used when filling a hot tub for the first time or at refill. It attaches to a garden hose and filters out rust, dirt, detergents, algae and chemicals.

Sodium Dichlor (chlorine) is the only recommended sanitizer that will work in conjunction with all of the other products in this system.

FreshWater III high output ozone system uses Corona Discharge technology to produce a high concentration of ozone which is injected into the hot tub water.

Monopersulfate (MPS) is an oxidizing chemical used to prevent the buildup of contaminants, maximize sanitizer efficiency, minimize combined chlorine, and improve water clarity.

FreshWater_{Ag+} silver ion purifier introduces silver ions into the hot tub water, inhibiting bacteria growth. When combined with MPS, or chlorine, oxidizes particulates in the hot tub water.

It is important to follow the recommended application and maintenance programs outlined for each product's use.

If the hot tub is being used over an extended period of time, such as a whole afternoon or evening, additional sanitizer will be needed.

A weekly "shock treatment" is required.

The shock treatment quickly destroys any remaining contaminants while revitalizing the silver ion cartridge, allowing the silver ions to continue to be released into the water. Without this weekly shock treatment, the silver ion cartridge may stop releasing silver ions into the water.

To weekly "shock treat" your hot tub you may use either MPS or sodium dichlor. It will require much less sodium dichlor to administer the shock treatment than MPS (one teaspoon of sodium dichlor has oxidizing capabilities comparable to two tablespoons of MPS). Sodium dichlor may be a more appropriate weekly shock for those users that experience heavy bather load conditions.

IMPORTANT NOTE: MPS is an oxidizer, not a sanitizer.

EVERFRESH WATER TREATMENT GUIDE

| | | | | |
|--|---|--------------|---|----------------|
| At hot tub startup or refill | Follow Start-Up and Refill Procedures section NOTE: Use the <i>FreshStart</i> _{10,000} pre-filter when filling the spa to remove unwanted contaminants. | | | |
| Prior to each use | Add one half (½) teaspoon of sodium dichlor per 250-gallons (950 liters) | OR | Add one (1) tablespoon of monopersulfate (MPS)* per 250-gallons (950 liters) | |
| <small>(Test before adding any chemicals; do not add any chemicals if proper, or higher levels are found.)</small> | Limelight® Pulse® (Model PLS) | ¾ teaspoon | Limelight Pulse (Model PLS) | 1½ tablespoons |
| | Limelight Flair® (Model FLR) | ½ teaspoon | Limelight Flair (Model FLR) | 1 tablespoon |
| | Limelight Glow® (Model GLW) | ½ teaspoon | Limelight Glow (Model GLW) | 1 tablespoon |
| Once a week | Add one and one half (1½) teaspoons of sodium dichlor per 250-gallons (950 liters) | OR | Add three (3) tablespoons of monopersulfate (MPS)* per 250-gallons (950 liters) | |
| | Limelight Pulse (Model PLS) | 2 teaspoons | Limelight Pulse (Model PLS) | 4 tablespoons |
| | Limelight Flair (Model FLR) | 1½ teaspoons | Limelight Flair (Model FLR) | 3 tablespoons |
| | Limelight Glow (Model GLW) | 1½ teaspoons | Limelight Glow (Model GLW) | 3 tablespoons |
| Every four months | Drain and refill your hot tub. Replace the <i>FreshWater</i> _{Ag+} silver ion purifier NOTE: Use the <i>FreshStart</i> _{10,000} pre-filter when filling the hot tub to remove unwanted contaminants. | | | |
| As needed, if water is hazy, cloudy, or has an odor | Add one and one half (1½) teaspoons of sodium dichlor per 250-gallons (950 liters) | | | |
| | Limelight Pulse (Model PLS) | 2 teaspoons | | |
| | Limelight Flair (Model FLR) | 1½ teaspoons | | |
| | Limelight Glow (Model GLW) | 1½ teaspoons | | |

FRESHWATER_{Ag+}® SILVER ION PURIFIER REPLACEMENT

When replacing the silver ion purifier (every four months), it is highly recommended that the hot tub be drained and refilled at the same time. After refilling the hot tub with water, balance the Total Alkalinity (TA), Calcium Hardness (CH) and pH to the recommended levels. Shock the hot tub by adding sodium dichlor (See Sanitization Table for details).

1. Fold back the vinyl cover.
2. Carefully remove and set aside the filter compartment cover.
3. Remove any floating items within the filter compartment.
4. Locate the gray filter cap. Turn the filter cap counterclockwise until the cap can be removed from the filter standpipe.
5. Remove and clean filter cartridge.

NOTE: When replacing the *FreshWater*_{Ag+} silver ion purifier, it is an excellent time to clean and rotate the filter to extend its life. To rotate the filter, simply replace the existing filter with another one. Then clean and store the old one until the next time the *FreshWater*_{Ag+} silver ion purifier needs replacement.

6. Remove the existing *FreshWater*_{Ag+} silver ion purifier.
7. Install the new *FreshWater*_{Ag+} silver ion purifier into the filter standpipe. Do not force the *FreshWater*_{Ag+} silver ion purifier down into the filter standpipe.
8. Reinstall the cleaned filter cartridge.
9. Replace and secure the gray filter cap.
10. Replace the filter compartment cover.
11. Fold the cover back into place.

⚠ WARNING: Never use the hot tub with the filter cartridge or filter standpipe removed!

*MPS is an oxidizer, not a sanitizer.

NOTE: Use the *FreshStart*_{10,000} pre-filter when filling the spa to remove unwanted contaminants.

SILVER IONS QUESTIONS AND ANSWERS

Question: How are the silver ions actually added to the water?

Answer: The silver ion cartridge contains ceramic beads that are infused with silver. By placing the cartridge in the circulation pump filter standpipe, it is subjected to the continuous flow of water created by the pump's 24 hour circulation. The flowing water, through a chemical erosion process, carries with it the silver ions necessary to add a sanitizing residual to the hot tub water.

Question: What happens if I do not add the weekly shock treatment?

Answer: The contaminants in the water may coat the silver ion cartridge's ceramic beads, blocking the silver ions' release into the water. When this occurs, there will be no residual of silver ions present in the water, eliminating them from the sanitizing process.

Question: How often should the FreshWater[®]Ag⁺ silver ion purifier cartridge be replaced?

Answer: The cartridge must be replaced every four months. Please refer to the instructions provided with each FreshWater[®]Ag⁺ silver ion purifier cartridge.

Question: Can I use the FreshWater III ozone system in addition to the silver ion system?

Answer: Yes. In fact, it is preferred! The use of the FreshWater III ozone system will enhance the performance of the silver ions and may substantially reduce the need for supplemental chemical treatments when the hot tub is not in use.

Question: Why can't I use bromine or biguanides instead of MPS or chlorine?

Answer: Bromine and biguanides will chemically react with the sanitizing action of the silver ions. This will eliminate their beneficial sanitizing effect.

DOS AND DON'TS

- DO check your MPS or sodium dichlor chemical level prior to each use.
- DO check your sanitizer prior to each use.
- DO change the FreshWater[®]Ag⁺ silver ion purifier every four months.
- DO test Total Alkalinity and pH weekly.
- DO use MPS for hot tubs only, such as Hot Spring[®] MPS chlorine-free oxidizer.
- DO store all chemicals in a tightly sealed container in a cool, dry place.
- DON'T use bromine or biguanides. These are active sanitizers and will combine with the silver ions to inactivate them.
- DON'T use a water clarifier. Clarifiers will cause the hot tub water to become cloudy.

CHLORINE (SODIUM DICHLOR)

- Sanitizing chemicals, such as chlorine, are oxidants that kill bacteria and viruses in the water. The Free Available Chlorine (FAC) is a measure of the amount of unused chlorine available to sanitize the hot tub. The recommended FAC for your hot tub water is 3.0-5.0 ppm.
- Watkins Manufacturing Corporation recommends the use of sodium dichlor type granulated chlorine for sanitizing the water. Sodium dichlor is preferred because it is totally soluble, dissolves quickly and is nearly pH neutral.
- Maintaining the proper level of chlorine during use is extremely important.
- If the FAC is too low, bacteria and viruses can grow rapidly in the warm water. **Increase the FAC by adding granulated sodium dichlor.**
- If the FAC is too high, the water can cause discomfort to the user's eyes, lungs and skin. **Simply allow some time to pass. The FAC level will naturally drop over time.**
- When the Free Available Chlorine is within the recommended range, the hot tub is ready to be enjoyed.

| | |
|---|---|
| CHLORINE DPD TEST KIT OR TEST STRIP READING | DO NOT USE THE SPA UNTIL THE TEST KIT READING IS BELOW THIS LEVEL |
| 5.0 | RECOMMENDED LEVEL SAFE |
| 4.0 | |
| 3.0 | |
| ADD CHLORINE | |
| 2.0 | DO NOT USE SPA ; ADD CHLORINE TO REACH RECOMMENDED SAFE LEVEL |
| 1.0 | |
| 0 | |

⚠ WARNING: There are several forms of stabilized chlorine available for use in hot tubs and swimming pools and each form has specific chemical characteristics. It is extremely important that the one you choose is specifically designed for use in hot tubs. Use of an incorrect product such as tri-chlor, which has a very low pH (2.6), dissolves too quickly in hot water resulting in extremely high levels of chlorine, and is designed for concrete or plaster swimming pools, **WILL** cause damage to your hot tub. Use of a liquid or any type of compressed bromine or chlorine, acid or any type of sanitizer which is not recommended by Watkins Manufacturing Corporation **WILL** damage your hot tub and is specifically not covered under the terms of the limited warranty.

IMPORTANT: Granulated chlorine (sodium dichlor) will degrade if stored improperly. We recommend purchasing chlorine in one or two pound containers and storing it in a cool, dry place to maintain its potency.

SUPER CHLORINATION

Super chlorination is designed to "burn-off" the build-up of chloramines (used chlorine), to eliminate the chlorine smell and to allow the proper level of free chlorine to be maintained.

When giving your water a super chlorination treatment, open the cover at least half way for twenty minutes to allow the chlorine gas to vent off. The high concentration of chlorine gas which may exist as a result of super chlorination (not daily sanitation) may eventually cause discoloration or

degradation to the bottom of the cover or the tile grouting, which would not be covered under the terms of your limited warranty.

⚠ **WARNING:** Always allow the Free Available Chlorine to fall to 5 ppm before using the hot tub.

⚠ **WARNING:** Never leave an open hot tub unattended, especially if there are children present!

BUILDING A SANITIZER ROUTINE

During the first month of ownership, measure the sanitizer residual daily in order to establish standards for User Load and Usage Time versus Sanitizer Needed.

- The User Load of the hot tub is the number of times anyone enters the hot tub.
- The Usage Time is simply the amount of time a user spends in the hot tub.
- Sanitizer Needed is the amount of Free Chlorine Residual needed to accommodate the number of users and their combined usage time.

For example, two hot tub users who regularly use the hot tub once an evening for twenty minutes create a specific and somewhat consistent demand on the sanitizer. During the first month of ownership, these two users can determine exactly how much sanitizer to use in order to maintain the proper residual. If, at any time, the user load and/or usage pattern changes dramatically (invited guests), the amount and frequency of sanitizer required increases dramatically.

The greater the usage time or the user load, the faster the residual value is diminished.

SUPPLEMENTAL WATER MAINTENANCE

Proper water sanitation and mineral balance (pH control) are absolutely essential for a complete hot tub water maintenance program. Here are three other popular water additives that are optional:

MINERAL DEPOSIT INHIBITORS

As water evaporates from your hot tub and new water is added, the amount of dissolved minerals will increase. (Minimize evaporation by keeping the cover on the hot tub whenever possible.) The hot tub water may eventually become "hard" (Calcium Hardness too high) enough to damage the heater by calcifying its surface. Proper pH control can minimize this.

Normal soap build-up will require water replacement regularly enough that mineral deposits normally are not a problem.

Occasionally, high iron or copper content in the water may produce green or brown stains on the hot tub. A mineral deposit inhibitor may help to reduce these metals.

NOTE: Well water may contain high concentrations of minerals. The use of a low water volume, extra-fine pore water filter (in-line pre-filter such as the FreshStart[®] 10,000 pre-filter) will help to remove many of the larger particles during the filling of the hot tub. In-line pre-filters can be purchased at your local Limelight[®] dealer.

FOAM INHIBITORS

Hot tub water requires changing due to the buildup of soap in the water. Typically, soap will cause the hot tub water to foam when the jets are used. Soap is introduced into the hot tub water from two sources: users' bodies, which retain a soap residual after showering, and swimming apparel, which retains soap after washing.

Foam inhibitors can suppress foam, but cannot remove soap from the water. Soap is very difficult to remove from the water because soap is not oxidized by any chemical added to the hot tub. Only ozone can oxidize soap.

Eventually the soap build-up in the water will be concentrated, resulting in an unclean feeling on the bather's skin which is impossible to remedy. When this occurs, it's time to drain and refill the hot tub. Depending on the soap input, the water should last about four months before needing to be drained.

OZONE (OPTIONAL EQUIPMENT)

Ozone is a powerful oxidizing agent which is produced in nature, and artificially by man. Ozone will oxidize a wide range of water contaminants, from soap residue to bacteria.

The FreshWater[®] III high-output ozone system is the only ozone purification system approved for installation in your Limelight hot tub. The FreshWater III ozone system features Corona Discharge (CD) technology to produce a higher concentration of ozone than is produced by competing ultraviolet light (UV) ozone systems.



The under-the-cabinet mounted FreshWater III high-output ozone system offers less-visible installation and is less susceptible to the effects of freezing temperatures. To access it for inspection, remove the equipment compartment panel to check the unit operation (this is usually done prior to disconnecting the power to the hot tub before draining).

The FreshWater III high-output ozone system greatly enhances the quality of the hot tub water when used to supplement the hot tub owner's regular water maintenance program. Contrary to some information circulated throughout the pool and hot tub industry regarding ozone systems, ozone **CAN NOT** be used as a single-source sanitizer, water clarifier, anti-foamer, and mineral chelating agent. A secondary source sanitizer must be used to maintain 2.0 ppm (2.0 mg/L) of Free Available Chlorine (FAC). Watkins Manufacturing Corporation recommends that a chemical maintenance program based on recognized and documented industry standards still be followed when using an ozone purification system to assure water sanitation and the highest quality purified water.

CLEANING THE OZONE INJECTOR (OPTIONAL EQUIPMENT)

On occasion, a mineral build-up may clog the ozone injector, causing a lack of flow, or low flow of ozone bubbles. To prevent this, refer to the following instructions to clean the injector:

1. Disconnect power to the hot tub.
2. Access the equipment compartment.
3. Locate the ozonator in the equipment compartment and unplug the ozonator from the control box.

| | | |
|--|--|--|
|  WARNING | <p><i>Nitric acid accumulates in the air lines of the ozonator and injector. Nitric acid will cause severe chemical burns if direct skin contact is made, so always wear protective gloves, glasses and clothing when working on the ozonator or injector lines. To prevent inhalation or ingestion of the nitric acid, DO NOT blow or inhale with your mouth to any of the adapters, fittings or tubing of the ozonator or injector air lines.</i></p> |  WARNING |
|--|--|--|

4. Place 16 ounces of white vinegar into a container such as a cup or bucket. Place the container on the equipment compartment floor.
NOTE: White vinegar will not damage any of the hot tub components.
5. Carefully loosen the long Tygon/Kynar tubing to the bottom of the ozonator. **A liquid substance may be found inside the tubing. If a liquid substance is present, BE CERTAIN NOT TO COME INTO CONTACT WITH THE LIQUID (SEE WARNING ON ABOVE).**
6. Place the end of the tubing into the vinegar, making certain that the end of the tubing sits at the bottom of the container.
7. Reconnect power to the hot tub.
8. Run the hot tub until all 16 ounces of the vinegar are gone. This should allow an ample flow of vinegar to be run through the injector and clear the blockage.
9. Disconnect power to the hot tub.
10. Remove the empty cup or bucket.
11. Reinstall the tubing to the bottom of the ozonator.
12. Plug the ozonator into the control box.
13. Close the equipment compartment door.
14. Reconnect power to the hot tub.

DOS AND DON'TS

- DO use only a granular form of sanitizer.
- DO add all chemicals slowly into the filter compartment with the jet pump operating for ten minutes.
- DO use special care if using baking soda to clean either the interior or exterior plastic surface
- DON'T use swimming pool (muriatic) acid to lower pH.
- DON'T splash pH increaser additives on the ELMwood™ cabinet.
- DON'T use Compressed Sanitizers.

The use of bromine sticks or tablets in floaters, which may become entrapped in a lounge or cooling seat (or sink to the hot tub floor), have been shown to cause discoloration of or surface distress to a hot tub's shell.

- DON'T use a floater type sanitization system as a low or no maintenance solution to your hot tub maintenance program.

The hot tub shell easily can withstand the effects of a properly administered sanitizer. Floating dispensers can become trapped in one area and cause an over-sanitization (or chemical burn) of that particular area.

If the dispenser setting is too high, the high concentration can discolor the hot tub shell and damage the underside of the cover.

Automatic floating dispensers have a tendency to either over-brominate or under-brominate as the rate of erosion varies greatly. Damage to the hot tub and cover can occur very quickly.

⚠ WARNING: Watkins Manufacturing Corporation **DOES NOT** recommend the use of any floating chemical dispenser. Damage to the hot tub shell or components caused by a floating chemical dispenser is specifically not covered under the terms of the limited warranty.

- DON'T use a sanitizer which is not designed for hot tubs.
- DON'T use household bleach (liquid sodium hypochlorite).
- DON'T broadcast or sprinkle the chemicals onto the water surface. This method may cause chemically-induced hot tub surface blistering (chemical abuse).

COMMON WATER CHEMISTRY QUESTIONS

Question: Why can't I use a floater to sanitize my hot tub water?

Answer: Watkins Manufacturing Corporation does not recommend the use of a floater for three reasons.

1. The floater is unable to control the rate at which sanitizer is dissolved into the water. When a floater is first placed in a hot tub, the sanitizer level can be extremely high. High sanitizer levels can chemically burn or discolor the hot tub's shell or the underside of the cover. Then, after a period of time, the sanitizer level dispensed by the floater will fall to near zero. A low sanitizer level will allow viruses, bacteria or algae to grow.
2. Floaters tend to stay in one area of the hot tub most of the time (usually over the cool down seat), causing this area to be exposed to extreme sanitizer levels.
3. The floater may allow pieces of the highly concentrated sanitizer to fall out and settle on the floor or seat of the hot tub shell. These pieces of sanitizer will chemically burn (blister) the hot tub shell. Although your hot tub shell is specifically designed to resist the effects of hot tub chemicals, no hot tub surface can withstand this type of highly concentrated chemical. Remember, chemical abuse is specifically not covered under the terms of the warranty.

Question: When I open my hot tub, I smell chlorine. How do I get rid of this smell?

Answer: There are two types of chlorine in your hot tub. The first is the Free Available Chlorine, which is the chlorine available to sanitize your hot tub. This available free chlorine does not have an odor. The second is Chloramine, which is residue from chlorine already expended. Chloramines have a strong chlorine odor. The smell from Chloramines can be eliminated by "shocking" the water. If you smell chlorine in the water, your hot tub is reminding you to add a shock treatment.

Question: Why can't I fill my hot tub with soft water?

Answer: Soft water is essentially the same as regular water except that most or all of the calcium has been replaced by sodium. Soft water may be corrosive to the heater and other components. Replacement of hot tub components damaged by soft water is extremely expensive.

Question: I am trying to reduce the number of chemicals to which my family is exposed. Do I really need to use so many chemicals and in such large amounts?

Answer: While over-exposure to any chemical can be unhealthful, many low levels of chemicals are effective and beneficial. In the case of hot tub water, the chemicals recommended in the Limelight® Water Maintenance Program are needed to protect the user from water-borne pathogens (disease-causing microbes) and to prevent corrosion of hot tub components. The EverFresh® water care system minimizes the use of chemicals with harsh side effects, such as halogen sanitizers.

Question: Why isn't water chemistry damage covered by the warranty?

Answer: The chemical levels and water quality of the water in the hot tub are under your direct control. With proper basic care, the hot tub will provide many years of hot water relaxation. If you are unsure about any chemical or its usage in the hot tub, contact your Authorized Dealer, or Watkins Manufacturing Corporation.

WATER TERMINOLOGY

The following chemical terms are used in this Water Quality and Maintenance section. Understanding their meaning will help you to better understand the water maintenance process.

Bromamines: Compounds formed when bromine combines with nitrogen from body oils, urine, perspiration, etc. Unlike chloramines, bromamines have no pungent odor, and are effective sanitizers.

Bromine: A halogen sanitizer (in the same chemical family as chlorine). Bromine is commonly used in stick, tablet, or granular form. See the DO's and DON'Ts of Hot tub Water Maintenance for additional information.

Calcium Hardness: The amount of dissolved calcium in the hot tub water. This should be approximately 100-150 ppm. High levels of calcium can cause cloudy water and scaling. Low levels can cause harm to the hot tub equipment.

Chloramines: Compounds formed when chlorine combines with nitrogen from body oils, urine, perspiration, etc. Chloramines can cause eye irritation as well as having a strong odor. Unlike bromamines, chloramines are weaker, slower sanitizers.

Chlorine: An efficient sanitizing chemical for hot tubs. Watkins Manufacturing Corporation recommends the use of sodium dichlor-type granulated chlorine. This type is preferred because it is totally soluble and nearly pH neutral.

Chlorine (or Bromine) Residual: The amount of chlorine or bromine remaining after chlorine or bromine demand has been satisfied. The residual is, therefore, the amount of sanitizer which is chemically available to kill bacteria, viruses and algae.

Corrosion: The gradual wearing away of metal hot tub parts, usually caused by chemical action. Generally, corrosion is caused by low pH or by water with levels of TA, CH, pH or sanitizer which are outside the recommended ranges.

DPD: The preferred reagent used in test kits to measure the Free Available Chlorine.

Halogen: Any one of these five elements: fluorine, chlorine, bromine, iodine, and astatine.

MPS: Monopersulfate is the non-chlorine oxidizer used with the FreshWater_{Ag+}® silver ion purification system.

Nitric Acid: The formulation of nitric acid, a highly corrosive chemical, is a byproduct of the ozone generating process. Nitric acid is produced in

very small quantities and is readily dissolved in the water stream with ozone.

Oxidizer: The use of an oxidizing chemical is to prevent the buildup of contaminants, maximize sanitizer efficiency, minimize combined chlorine and improve water clarity.

Ozone: Ozone is a powerful oxidizing agent which is produced in nature and artificially by man. Ozone forms no byproducts of chloramines (ozone actually oxidizes chloramines) and will not alter the water's pH.

Pathogen: A microorganism such as bacterium that cause disease.

pH: The measure of the hot tub water's acidity and alkalinity. The recommended pH for the hot tub water is 7.4 to 7.6. Below 7.0 (considered neutral), the hot tub water is too acidic and can damage the heating system. Above 7.8, the water is too alkaline and can result in cloudy water, and scale formation on the shell and heater.

ppm: The abbreviation of "parts per million", the standard measurement of chemical concentration in water. Identical to mg/l (milligrams per liter).

Reagent: A chemical material in liquid, powder, or tablet form for use in chemical testing.

Sanitizer: Sanitizers are added and maintained at recommended residuals to protect bathers against pathogenic organisms which can cause disease and infection in hot tub water.

Scale: Rough calcium-bearing deposits that can coat hot tub surfaces, heaters, plumbing lines, and clog filters. Generally, scaling is caused by mineral content combined with high pH. Additionally, scale forms more readily at higher water temperatures.

Super-Chlorination: Also known as "shock treatment." Super-Chlorination is a process of adding significant doses of a quick dissolving sanitizer ("dichlor" is recommended) to oxidize non-filterable organic waste and to remove chloramines and bromamines.

Total Alkalinity: The amount of bicarbonates, carbonates, and hydroxides present in hot tub water. Proper total alkalinity is important for pH control. If the TA is too high, the pH is difficult to adjust. If the TA is too low, the pH will be difficult to hold at the proper level. The desired range of TA in hot tub water is 40 to 120 ppm.

SERVICE INFORMATION

Your Limelight[®] hot tub has been designed to provide years of trouble-free use. As with any appliance, problems may occasionally occur that require the expertise of a qualified service person. Though such simple repairs as resetting a GFCI switch or breaker, resetting a high limit thermostat or replacing a light bulb may not require a service call, they may indicate that a more serious condition exists. These conditions may require an experienced service person. Before calling for service, please refer to the Troubleshooting Guide.

NOTE: Always retain your original sales receipt for future reference.

GFCI AND HIGH LIMIT THERMOSTAT

If your hot tub fails to operate at any time, first check the power supply to the hot tub.

Check each of the GFCI breakers in the subpanel. If a GFCI has tripped, reset it. If it will not reset, this may be an indication of a ground fault (short circuit) within the electrical components. Contact an Authorized Service Technician for a complete diagnosis.

If upon checking the GFCI's you find that they have not tripped, check the house breaker panel and ensure that the main breaker for the electrical circuit supplying the hot tub has not tripped. If it has, this is an indication that the circuit was either overloaded or a ground fault exists between the breaker panel and the hot tub receptacle or subpanel. Contact a qualified electrician.

If upon checking the main house breaker and hot tub GFCI's you find no failures, check the high limit thermostat. To check it, simply turn off power to the hot tub for 30 seconds. This will automatically reset the high limit thermostat if it has tripped. If the hot tub energizes once you turn the power back on, this indicates reduced water flow through the heating system. Tripping of the high limit thermostat is normally a result of one or a combination of these problems. 1) clogged filter cartridges, 2) blockage within the system plumbing, 3) a non-functioning heater circulation pump, 4) power was not disconnected from the hot tub before it was drained, 5) an air lock in the plumbing lines. (The Power Indicator on the front of the hot tub's control panel will also be blinking if the high limit thermostat circuit has tripped.)

If the hot tub does not function after tripping and resetting the GFCI's or resetting the high limit thermostat, then the problem should be referred to a qualified service technician. Refer to the Heater section if the hot tub operates but does not heat, or refer to the Troubleshooting Guide for additional service information.

NO-FAULT[®] HEATER AND INTEGRATED PRESSURE SWITCH

Watkins Manufacturing Corporation unconditionally warrants the No-Fault heater against any failure that would require replacement. This warranty's duration is equal to the time period identified in the Component Warranty. This warranty defines unconditional as warranty coverage without exception provided that the component has failed to operate properly within the hot tub's system. This means that conditions that would normally invalidate the limited warranty, such as water chemistry damage, do not apply to the No-Fault heater.

It is important to note that the No-Fault heater is protected by both the heater high limit thermostat circuit and the integrated pressure switch. The causes of heater high limit tripping are discussed in the previous section.

If the hot tub is not heating, the red and green lights are blinking, but the pump and light are operating, then the pressure switch may be open. Opening of the pressure switch is normally a result of one or a combination of these problems: 1) a clogged filter cartridge, 2) blockage within the system plumbing, 3) power was not disconnected to the hot tub before it was drained, or 4) an air lock in the plumbing lines. Once the problem has been identified and corrected the pressure switch will close which will energize the heater.

SILENT FLO 5000® CIRCULATION PUMP AND CIRCULATION PUMP THERMAL CUT-OFF

The Silent Flo circulation pump is a dedicated, water cooled, energy efficient, quiet pump that provides continuous filtration for the hot tub. Since the Silent Flo circulation pump is water cooled, it is equipped with a thermal cut-off to prevent the pump from being damaged by running hot when water is not present.

Reset the circulation pump's thermal cut-off by disconnecting power to the hot tub and allowing the pump to cool.

Tripping of the thermal cut-off is normally the result of one or a combination of these problems: 1) clogged filter cartridge(s), 2) blockage within the system plumbing, 3) power was not disconnected to the hot tub before it was drained, or 4) an air lock in the plumbing lines. Once the problem has been identified and corrected the pump thermal cut-off will be able to be reset which will allow it to operate normally.

FRESHWATER® III HIGH OUTPUT OZONE SYSTEM (OPTIONAL)

The FreshWater III ozone system is practically maintenance-free because it is located within the hot tub's equipment compartment.

⚠ WARNING: Contact your Lighthouse® dealer if your hot tub requires troubleshooting beyond the scope of this manual. Freshwater III ozone systems should only be serviced by a qualified technician.

WARRANTY NOTE: Cleaning of the ozone injector is not covered under the warranty. Refer to the Ozone section of this manual for instructions on cleaning the ozone injector.

MISCELLANEOUS SERVICE INFORMATION

The control and high-limit thermostats are equipped with electronic sensors that are connected to the hot tub's plumbing. Never cut or kink the wires that connect the sensors to the thermostats within the control box.

The jet pump is equipped with a thermal overload cutoff switch that is designed to protect the pump from overheating. If the pump shuts itself off in a new hot tub, it is usually the result of one or a combination of the following factors:

- Thermal overload: Although mass-produced, not all thermal overload cutoffs are exactly the same. Some are more sensitive than others and will shut the pump off at lower temperatures.
- High temperature: All Lighthouse® hot tubs models are equipped with a jet pump shroud that vents the heat generated by the pump motor to the outside of the equipment compartment, and back into the hot tub water. If the vent is blocked by masonry, grass or debris, overheating of the jet pump may occur. Once the pump motor has cooled sufficiently and any blockage has been removed from the vent opening, the jet pump can be restarted.
- Improper wiring: If the hot tub is connected incorrectly, and/or the house wiring is undersized, the pump may starve for voltage and therefore may draw more amperage and generate excessive heat.
- If the pump is shutting down due to excessive heat, make sure the equipment compartment has adequate ventilation. The air screens at the bottom must not be blocked. Should your jet pump continue to shut off after short periods of use, contact a qualified service technician.

ACTS INVALIDATING WARRANTY

The limited warranty is void if the Lighthouse hot tub has been subjected to alteration, misuse, or abuse, or if any repairs on the hot tub are attempted by anyone other than an authorized representative of Watkins Manufacturing Corporation. Alteration is defined as any component or plumbing change, electrical conversion, or the addition of any non-approved sanitation or water purification device, or heating system which contributes to a component failure, unit failure or unsafe operating condition. Misuse and abuse shall include any operation of the hot tub other than in accordance with Watkins Manufacturing Corporation printed instructions, or use of the hot tub in an application for which it is not designed; specifically: use of the hot tub in a non-residential application; damage caused by operation* of the hot tub at water temperatures outside the range of 35°F and 120°F; damage caused by a dirty, clogged or calcified filter cartridge; damage to the hot tub surface caused by the use of tri-chloro chlorine, BCDMH, chemical tablets in a floater, acid, or any other hot tub chemicals or hot tub surface cleaners which are not recommended by Watkins Manufacturing Corporation; damage caused by allowing undissolved hot tub sanitizing chemicals to lie on the hot tub surface (no hot tub surface material can withstand this kind of abuse); damage to components or hot tub surface caused by improper water chemistry maintenance; and damage to the hot tub surface caused by leaving the hot tub uncovered while empty of water and in direct exposure to sunlight (this may cause solar heating distress in warm weather regions). These are considered abuses and may invalidate this warranty.

Acts of nature, and damage caused by animals, rodents, and insects are considered abuses and are not covered under this warranty.

*Operation of the hot tub does not mean "use" of the hot tub! Watkins Manufacturing Corporation does not recommend using the hot tub if the water temperature is above or below the hot tub's control panel temperature range.

DISCLAIMERS

Watkins Manufacturing Corporation shall not be liable for loss of use of the Limelight hot tub or other incidental or consequential costs, expenses or damages, which may include but are not limited to, the removal of a permanent deck or other custom fixture. Any implied warranty shall have a duration equal to the duration of the applicable warranty stated above. Under no circumstances shall Watkins Manufacturing Corporation or any of its representatives be held liable for injury to any person or damage to any property, however arising.

WATKINS CUSTOMER SERVICE

If you have any questions about any aspect of your Limelight hot tub set-up, operation or maintenance that have not been answered by this manual, consult your Limelight dealer.

Watkins Manufacturing Corporation can be reached at: 800-999-4688 (Extension 8432), Monday through Friday, 8 a.m. to 5 p.m. Pacific Standard Time (PST), or e-mail custsvc@watkinsmfg.com.

TROUBLESHOOTING

Should you experience any problem, do not hesitate to contact your authorized Limelight® dealer. Here are some tips to help you to diagnose and rectify some more common sources of trouble yourself, if you choose to do so.

| GENERAL OPERATION TROUBLESHOOTING GUIDE | | |
|---|---|--|
| Problem | Probable causes | Solutions |
| Entire hot tub is inoperative | <ul style="list-style-type: none"> Power failure GFCI tripped Heater high-limit thermostat tripped Spa lock activated | <ul style="list-style-type: none"> Check power source Reset GFCI; call for service if it will not reset Disconnect power for at least thirty seconds to reset heater high limit. If it will not reset, check for clogged filter(s). If tripping continues, call for service. Deactivate spa lock |
| Hot tub does not heat; jets and light operate (Ready and Power indicators are blinking) | <ul style="list-style-type: none"> Integrated pressure switch open Circulation pump thermal cut-off tripped | <ul style="list-style-type: none"> Check for clogged filter. Integrated pressure switch will reset when the flow of water through the heater has been restored. Call for service if the heater trips frequently. Check for clogged filter or air locks in plumbing. Disconnect power to the spa, allow circulation pump to cool. Circulation pump thermal cut-off will reset when pump has cooled and power is reapplied. Call for service if circulation pump thermal cut-off trips frequently. |
| Jets weak or surging | <ul style="list-style-type: none"> Hot tub water level too low Filter(s) clogged Closed Air Control levers | <ul style="list-style-type: none"> Add water Clean filter Open Air Control levers |
| Light(s) inoperative | <ul style="list-style-type: none"> Spa lock activated Light, wiring or assembly is faulty | <ul style="list-style-type: none"> Deactivate spa lock Call for service |
| Power indicator blinking (Entire hot tub inoperative) | <ul style="list-style-type: none"> Hot tub water level too low Filter(s) clogged Closed Air Control levers | <ul style="list-style-type: none"> Disconnect power for at least thirty seconds to reset heater high limit. If it will not reset, check for clogged filter(s). If tripping continues, call for service. |
| Ready indicator blinking | <ul style="list-style-type: none"> Temperature sensor problem | <ul style="list-style-type: none"> Disconnect power for at least thirty seconds. If blinking continues, call for service. |

| HOT TUB WATER MAINTENANCE TROUBLESHOOTING GUIDE | | |
|---|--|---|
| Problem | Probable causes | Solutions |
| Cloudy Water | <ul style="list-style-type: none"> Dirty filters Excessive oils / organic matter Improper sanitization Suspended particles / organic matter Overused or old water | <ul style="list-style-type: none"> Clean filters Shock spa with sanitizer Add sanitizer Adjust pH and/or alkalinity to recommended range Run jet pump(s) and clean filters Drain and refill the spa |
| Water Odor | <ul style="list-style-type: none"> Excessive organics in water Improper sanitization Low pH | <ul style="list-style-type: none"> Shock spa with sanitizer Add sanitizer Adjust pH to recommended range |
| Chlorine Odor | <ul style="list-style-type: none"> Chloramine level too high Low pH | <ul style="list-style-type: none"> Shock spa with sanitizer Adjust pH to recommended range |
| Musty Odor | <ul style="list-style-type: none"> Bacteria or algae growth | <ul style="list-style-type: none"> Shock spa with sanitizer—if problem is visible or persistent, drain, clean and refill the spa |
| Organic buildup / scum ring around spa | <ul style="list-style-type: none"> Build-up of oils and dirt | <ul style="list-style-type: none"> Wipe off scum with clean rag – if severe, drain the spa, use a spa surface and tile cleaner to remove the scum, and refill the spa |
| Algae Growth | <ul style="list-style-type: none"> High pH Low sanitizer level | <ul style="list-style-type: none"> Shock spa with sanitizer and adjust pH Shock spa with sanitizer and maintain sanitizer level |
| Eye Irritation | <ul style="list-style-type: none"> Low pH Low sanitizer level | <ul style="list-style-type: none"> Adjust pH Shock spa with sanitizer and maintain sanitizer level |
| Skin Irritation / Rash | <ul style="list-style-type: none"> Unsanitary water Free chlorine level above 5 ppm | <ul style="list-style-type: none"> Shock spa with sanitizer and maintain sanitizer level Allow free chlorine level to drop below 5 ppm before spa use |
| Stains | <ul style="list-style-type: none"> Total alkalinity and/or pH too low High iron or copper in source water | <ul style="list-style-type: none"> Adjust total alkalinity and/or pH Use a metal deposit inhibitor |
| Scale | <ul style="list-style-type: none"> High calcium content in water – total alkalinity and pH too high | <ul style="list-style-type: none"> Adjust total alkalinity and pH – if scale requires removal, drain the spa, scrub off the scale, refill the spa and balance the water |



Watkins Manufacturing Corporation
Vista, California
USA

This manual contains installation, operating, maintenance and service information for the following 2011 Limelight® spa models:

| USA MODEL | EFFECTIVE DATE |
|------------------------------|----------------|
| LIMELIGHT PULSE® (MODEL PLS) | 11/10 |
| LIMELIGHT FLAIR® (MODEL FLR) | 11/10 |
| LIMELIGHT GLOW® (MODEL GLW) | 11/10 |



©2010 Watkins Manufacturing Corporation. Limelight, Pulse, Flair, Glow, No-Fault, IQ 2020, ELMwood, Raio, Wavemaster, Silent Flo 5000, CoverCradle, Cover Shield, UpRite, Lift 'n Glide, EverFresh, FreshStart, FreshWater, Vidro, FreshWater_{Ag+}, and The Home Relaxation Specialists are trademarks of Watkins Manufacturing Corporation. BaquaSpa is a trademark of Arch UK Biocides Limited. Brominating Concentrate™ is a trademark of Bio-Lab Inc.

