



Tiger River® Spas

OWNER'S MANUAL

Tiger River[®] Spas

**Watkins[®] Manufacturing Corporation
congratulates you on your decision to enjoy
the finest spa available... Welcome to the
growing family of Tiger River[®] spa owners.**

Owner's Manual

This Owner's Manual will acquaint you with the operation and general maintenance of your new spa. We suggest that you take some time to carefully review all seven sections. Please keep this manual available for reference.

If you have any questions about any aspect of your spa's set-up, operation or maintenance, contact your authorized Tiger River dealership. They are trained professionals who are familiar with the product as well as new spa ownership concerns. Their expertise will facilitate the enjoyment of your new Tiger River spa.

The serial number label is located within the equipment compartment of your Tiger River spa.

IMPORTANT: Watkins Manufacturing Corporation reserves the right to change specifications, or design, without notification and without incurring any obligation.

DATE PURCHASED: _____

DATE INSTALLED: _____

DEALER: _____

ADDRESS: _____

TELEPHONE: _____

SPA MODEL/SERIAL NUMBER: _____

COVER SERIAL NUMBER: _____

ACCESSORY SERIAL NUMBERS: _____



In most cities and counties, permits will be required for the installation of electrical circuits or the construction of exterior surfaces (decks and gazebos). In addition, some communities have adopted residential barrier codes which may require fencing and/or self-closing gates on the property to prevent unsupervised access to a pool (or spa) by children under 5 years of age. Your Tiger River spa is equipped with a locking cover that meets the ASTM F1346-91 Standard for Safety Covers and as a result, is usually exempt from most barrier requirements. As a general practice, your local Building Department will inform you of any applicable barrier requirements at the time a permit is obtained for the installation of an electrical circuit. Your Tiger River dealer can provide information on which permits may be required.

Welcome

Table of Contents

SAFETY INFORMATION

Important Safety Instructions	1
Important Spa Instructions	3

SPA SPECIFICATIONS

INSTALLATION INSTRUCTIONS

Site Preparation	5
Outdoor and Patio Installation	5
Deck Installation	5
Indoor Installation	5
Spa Leveling Instructions	6

CONTROLS AND EQUIPMENT

Caspian™ (Model CHP)	10
Bengal® (Model M / MM)	11
Sumatran® (Model N)	12

ELECTRICAL REQUIREMENTS AND PRECAUTIONS

230 Volt Permanently Connected Models	13
115 / 230 Volt Convertible Models	15
115 Volt Operation	17

OPERATING INSTRUCTIONS

230 Volt Permanently Connected Model	18
115 / 230 Volt Convertible Models	18
Start-Up and Refill Procedures	19
SmartJet® System	20
Comfort Control® System	20
Jets	20
115 Volt GFCI	21
Water Feature	21

JET MENU

Caspian (Model CHP)	22
Bengal (Model M)	23
Bengal (Model MM)	24
Sumatran (Model N)	25

CONTROL PANEL OPERATIONS

Control Panel	25
Control Panel Buttons and Display	26
Indicator Lights	26

Control Panel Menu Display	27
Temperature Control	27
System Mode	27
Tools Menu	27
Display Inversion	29

SPA CARE AND MAINTENANCE

Draining the Water	29
Filter System	29
Filter Cartridge Removal and Cleaning	30
Care of the Spa Pillows	30
Care of the Exterior	31
SureWood® Spa Cabinet	31
Care of the Spa Cover	31
Retractable Cover Systems	32
Vacation Care Instructions	33
Prevention of Freezing	33

WATER QUALITY AND MAINTENANCE

General Information	34
Methods for Testing the Spa Water	34
Tiger River® Spa Water Maintenance Program	35
EverFresh® Water Care System	37
Freshwater Ag+® Silver Ion Purifier Replacement	37
Tiger River Water Treatment Guide	38
Chlorine (Sodium Dichlor)	39
Ozone	40
Common Water Chemistry Questions	41
Water Terminology	42

SERVICE INFORMATION

GFCI and High Limit Thermostat	43
No-Fault® Heater and Heater Thermal Cut-off	43
Silent Flo® 5000 Circulation Pump Thermal Cut-off	44
Freshwater® III High Output Ozone System	44
Miscellaneous Service Information	44
Acts Invalidating Warranty	44
Disclaimers	45
Watkins Customer Service	45
Troubleshooting Guides	46
Spa Care and Maintenance Record	47

SAFETY INFORMATION

IMPORTANT SAFETY INSTRUCTIONS

READ AND FOLLOW ALL INSTRUCTIONS

AVOIDING THE RISK TO CHILDREN

DANGER:

- **RISK OF CHILD DROWNING.** Extreme caution must be exercised to prevent unauthorized access by children. To avoid accidents, ensure that children cannot use a spa unless they are supervised at all times.

WARNING:

- To reduce the risk of injury, do not permit children to use this spa unless they are closely supervised at all times.
- To reduce the risk of injury, lower water temperatures are recommended for young children. Children are especially sensitive to hot water.

DO:

- Make sure you always lock the child resistant locks after using the spa for your children's safety. Every Tiger River® spa is equipped with a locking cover that meets the ASTM F1346-91 Standard for Safety Covers.
- Test the water temperature with your hand before allowing your children to enter the spa to be sure that it's comfortable. Children are especially sensitive to hot water.
- Remind children that wet surfaces can be very slippery. Make sure that children are careful when entering or exiting the spa.

DON'T:

- Allow children to climb onto the spa cover.
- Allow children to have unsupervised access to the spa.

AVOIDING THE RISK OF ELECTROCUTION

Risk of electrocution

- Connect only to a grounded source.
- Do not bury the power cord. A buried power cord may result in death, or serious personal injury due to electrocution if direct burial-type cable is not used, or if improper digging occurs.
- A ground terminal (pressure wire connector) is provided on the control box inside the unit to permit connection of a minimum No. 10 AWG (6 mm²) solid copper bonding conductor between this point and any metal equipment, metal water pipe, metal enclosures of electrical equipment, or conduit within five feet (1.5 m) of the unit as needed to comply with local requirements.

WARNING:

- To reduce the risk of electrical shock, replace a damaged cord immediately. Failure to do so may result in death or serious personal injury due to electrocution.
- Your spa is provided with a Ground Fault Circuit Interrupter for user and equipment protection. To ensure proper operation of this important safety device, test according to the following instructions per electrical configuration.

Cord-Connected 115 volt, 20 amp models: The GFCI is located at the end of the power cord. Before each use, with the unit operating, push the TEST button. The unit should stop operating and the GFCI power indicator will go out. Wait 30 seconds and then reset the GFCI by pushing the RESET button. The GFCI power indicator will turn on, restoring power to the spa. If the interrupter does not perform in this manner, there may be an electrical malfunction and with it, the possibility of an electric shock. Disconnect the power until the problem has been corrected.

230 volt, permanently installed or converted models:

- A ground terminal is provided on the terminal block (TB-1, system ground terminal) located inside the control box. To reduce the risk of electric shock, connect this terminal to the grounding terminal of your electrical service or supply panel with a continuous green, insulated copper wire. The wire must be equivalent in size to the circuit conductors supplying the equipment. In addition, a bonding terminal (pressure wire connector) is provided on the outside of the control box for bonding to local ground points. To reduce the risk of electric shock, this connector should be bonded with a No. 10 AWG (6 mm²) solid copper wire to any metal ladders, water pipes, or other metal within 5 feet (1.5 m) of the spa to comply with local requirements. The means of disconnection must be readily accessible, but must be installed at least 5 feet (1.5 m) from the spa.
- Your spa is provided with a suitably rated circuit breaker to open all ungrounded supply conductors.

- Your spa uses ground fault circuit interrupters in the electrical subpanel. Before each use of the spa and with the unit operating, push the TEST button on each breaker. The switch should click over to the “Trip” position. Wait 30 seconds and reset each GFCI breaker by switching it completely off and then completely on. The switch should then stay on. If either of the interrupters does not perform in this manner, it is an indication of an electrical malfunction and the possibility of an electric shock. Disconnect the power until the fault has been identified and corrected.

NOTE: Failure to wait 30 seconds before resetting the GFCI may cause the spa’s Power Indicator (on the control panel) to blink. If this occurs, repeat the GFCI test procedure.

DANGER: RISK OF ELECTRICAL SHOCK

- Install at least 5 feet (1.5 m) from all metal surfaces. A spa may be installed within 5 feet of a metal surface if each metal surface is permanently connected by a minimum No. 10 AWG (6 mm²) solid copper conductor attached to the wire ground connector on the terminal box that is provided for this purpose if in accordance with National Electrical Code ANSI/NMFA70-1993.
- Do not permit any electrical appliances, such as a light, telephone, radio, or television within 5 feet (1.5 m) of a spa. Failure to maintain a safe distance may result in death, or serious personal injury due to electrocution if the appliance should fall into the spa.
- Install your spa in such a way that drainage is away from the electrical compartment and from all electrical components.

DO:

- Be sure your spa is connected to the power supply correctly - use a licensed contractor.
- Disconnect the spa from the power supply before draining the spa or servicing the electrical components.
- Test the Ground Fault Circuit Interrupter(s) before each use.

DON'T:

- Use the spa with the equipment compartment door removed.
- Place electrical appliances within 5 feet (1.5m) of the spa.
- Use an extension cord to connect the spa to its power source. The cord may not be properly grounded and the connection is a shock hazard. An extension cord may cause a voltage drop, which will cause overheating of the jet pump motor and motor damage.
- Attempt to open the electrical control box. There are no user serviceable parts inside.

RISKS TO AVOID

DANGER: RISK OF INJURY

- To reduce the risk of injury to persons, DO NOT remove suction fittings (filter standpipes) located in the filter compartment.
- The suction fittings in the spa are sized to match the specific water flow created by the pump. Never replace a suction fitting with one rated less than the flow rate marked on the original suction fitting.
- There is a danger of slipping and falling. Remember that wet surfaces can be very slippery. Take care when entering or exiting the spa.
- Never operate spa if the suction fittings are broken or missing.
- People with infectious diseases should not use the spa.
- Keep any loose articles of clothing or hanging jewelry away from rotating jets or other moving components.

Increased side effects of medication

- The use of drugs, alcohol, or medication before or during spa use may lead to unconsciousness with the possibility of drowning.
- Persons using medications should consult a physician before using a spa; some medication may cause a user to become drowsy, while other medication may affect heart rate, blood pressure, and circulation.
- Persons taking medications which induce drowsiness, such as tranquilizers, antihistamines or anticoagulants should not use the spa.

Health problems affected by spa use

- Pregnant women should consult a physician before using spa.
- Persons suffering from obesity, or with a medical history of heart disease, low or high blood pressure, circulatory system problems, or diabetes should consult a physician before using spa.

Unclean water

- Keep the water clean and sanitized with correct chemical care. The recommended levels for your Tiger River® spa are:

- Free Available Chlorine (FAC):	3.0-5.0 ppm	- Total Alkalinity:	125-150 ppm
- Water pH:	7.4-7.6	- Calcium Hardness:	150-200 ppm

(Refer to Water Quality and Maintenance section for complete instructions.)

IMPORTANT: Turn on the jet pump for a least ten minutes after adding ANY spa water chemicals into the filter compartment.

- Clean the filter cartridge monthly to remove debris and mineral buildup which may affect the performance of the hydromassage jets, limit the flow, or trip the high limit thermostat which will turn off the entire spa.

AVOIDING THE RISK OF HYPERTHERMIA

Prolonged immersion in hot water can result in HYPERTHERMIA, a dangerous condition which occurs when the internal temperature of the body reaches a level above normal (98.6°F). The symptoms of hyperthermia include unawareness of impending hazard, failure to perceive heat, failure to recognize the need to exit the spa, physical inability to exit the spa, fetal damage in pregnant women, and unconsciousness resulting in a danger of drowning.

WARNING:

The use of alcohol, drugs, or medication can greatly increase the risk of fatal hyperthermia in hot tubs and spas.

TO REDUCE THE RISK OF INJURY:

- The water in the spa should never exceed 104°F. Water temperatures between 100°F and 104°F are considered safe for a healthy adult. Lower water temperatures are recommended for extended use (exceeding ten minutes) and for young children. Extended use can cause hyperthermia.
- Pregnant or possibly pregnant women should limit spa water temperatures to 100°F. Failure to do so may result in permanent injury to your baby.
- Do not use spa immediately following strenuous exercise.

AVOIDING THE RISK OF SKIN BURNS:

- To reduce the risk of injury, before entering a spa the user should measure the water temperature with an accurate thermometer, since the tolerance of temperature-regulating devices may vary by as much as ±5°F.
- Test the water with your hand before entering the spa to be sure it's comfortable.

SAFETY SIGN

Each Tiger River® spa is shipped with a SAFETY SIGN in the owner's package. The sign, which is required as a condition of Product Listing, should be permanently installed where it is visible to the users of the spa. To obtain additional SAFETY SIGNS, contact your Tiger River dealer and request Part #70798.

IMPORTANT SPA INSTRUCTIONS

The following contains important spa information, and we strongly encourage you to read and apply them.

DO:

- Use and lock the vinyl cover when the spa is not in use, whether it is empty or full.
- Follow the Spa Care and Maintenance recommendations stated in this manual.
- Use only approved accessories and recommended spa chemicals and cleaners.

DON'T:

- Leave the Tiger River spa exposed to the sun without water or the cover in place. Exposure to direct sunlight can cause solar distress of the shell material.
- Roll or slide the spa on its side. This will damage the siding.
- Lift or drag the vinyl cover by using the tie-down straps; always lift or carry the cover by using the handles.
- Attempt to open the electrical control box. There are no user serviceable parts inside. Opening of the control box by the spa owner will void the warranty. If you have an operational problem, carefully go through the steps outlined in the Troubleshooting section. If you are not able to resolve the problem, contact your authorized Tiger River dealer. Many problems can easily be diagnosed over the telephone by an Authorized Service Technician.

SAVE THESE INSTRUCTIONS

SPA SPECIFICATIONS

	Footprint dimensions	Height	Effective filter area	Heater (Watts)	Water capacity	Dry weight	Filled weight*	Dead weight*	Electrical Requirements
Caspian™ (Model CHP)	7'0" x 7'0" 2.13m x 2.13m	36" . .91m	65 square feet	4,000 (230 volt)	330 gallons 1,249 litres	789 lbs. 358 kg.	4,479 lbs. 2,032 kg.	110 lbs. per square foot	115v System: Not available 230v System: 230 volt, 50 Amp single phase GFCI protected circuit
Bengal® (Model M)	7'2-1/2" x 6'7" 2.2m x 2.01m	33" . .84m	65 square feet	1,500 (115 volt) 6,000 (230 volt)	330 gallons 1,249 litres	689 lbs. 312 kg.	4,204 lbs. 1,907 kg.	105 lbs. per square foot	115v System: 115 volt, 20 amp dedicated circuit 230v System: 230 volt, 50 amp single phase GFCI protected circuit
Bengal (Model MM)	7'2-1/2" x 6'7" 2.2m x 2.01m	33" . .84m	65 square feet	6,000 (230 volt)	330 gallons 1,249 litres	689 lbs. 312 kg.	4,204 lbs. 1,907 kg.	105 lbs. per square foot	115v System: Not available 230v System: 230 volt, 50 Amp single phase GFCI protected circuit
Sumatran® (Model N)	6'6" x 6'6" 1.98m x 1.98m	33" . .84m	65 square feet	1,500 (115 volt) 6,000 (230 volt)	310 gallons 1,173 litres	613 lbs. 278 kg.	3,793 lbs. 1,720 kg.	105 lbs. per square foot	115v System: 115 volt, 20 amp dedicated circuit 230v System: 230 volt, 50 amp single phase GFCI protected circuit

CAUTION: Watkins Manufacturing Corporation suggests a structural engineer or contractor be consulted before the spa is placed on an elevated deck.

* **NOTE:** The "Filled weight" and "Dead weight" of the spa includes the weight of the occupants (assuming an average occupant weight of 175 lbs).

INSTALLATION INSTRUCTIONS

SITE PREPARATION

You probably have a spot picked out for your new spa, whether it's indoors or outdoors, on a patio or on a deck. Just make sure you check the following:

- Always put your spa on a structurally sound, level surface. A filled spa can weigh a great deal. Make certain that the location you choose can support the weight of your filled spa.
- Don't forget to level your spa before filling it. (See Spa Leveling Instructions.)
- Locate your equipment compartment, which houses all of the electrical components, in a place where water drainage will be away from it. Do not allow water into the equipment compartment. Water can cause damage to the electronics, or may trip the circuit breaker on your house's electrical panel.
- Leave yourself easy access to the circuit breakers in the subpanel (230 volt models), or to the interrupter switch on the end of the power cord (115 volt models).
- Never let water get into the subpanel (230 volt models), into the interrupter switch (115 volt models), or into the electrical outlet that your spa is plugged into. Your 115 volt Tiger River® spa comes with a protective box designed to keep out rain and water from sprinkler systems. Your 230 volt spa's subpanel is rain-tight when installed correctly with the door closed. Periodically check these conditions and correct any flaws if detected.
- Leave access to the equipment compartment for periodic spa care and maintenance.
- Your spa is equipped with an air-intake screen located between the base of the equipment compartment and the door. Make sure the screen remains clear of debris at all times, this is the only location that allows air to flow into the equipment compartment.

IMPORTANT: The air-intake screen must remain attached to the spa in order to deter rodents from entering the compartment.

⚠ **WARNING:** Damage to the spa's equipment compartment components or internal plumbing as a result of rodent infestation is **NOT** covered under your warranty!

OUTDOOR AND PATIO INSTALLATION

No matter where you install your new spa, it's important that you have a solid foundation to support it. Structural damage to the spa resulting from incorrect installation, or placement on an inadequate foundation, is not covered under the spa's limited warranty.

If you install the spa outdoors, we recommend a reinforced concrete pad at least four inches thick. The reinforcing rod or mesh in the pad should be attached to a #10 AWG bonding wire per national electrical codes (contact your local electrical code compliance inspector for more information; inspection for proper grounding may be required before pouring concrete to form the slab).

If you place the spa on the ground, even temporarily, place stepping stones under the leveling areas (see Spa Leveling Instructions). The stones should be at least two inches thick and twelve inches square. Even with stones in place, the spa will inevitably settle and become unlevel. Plus, a spa surrounded by dirt or grass will soon be filled with dirt or grass from users' feet; therefore, it's important to get it onto a solid foundation as soon as possible.

DECK INSTALLATION

To be certain your deck can support your spa, you must know the deck's maximum load capacity. Consult a qualified building contractor or structural engineer. To find the weight of your spa, its contents and occupants, refer to the Spa Specification chart. This weight per square foot must not exceed the structure's rated capacity, or serious structural damage could result.

INDOOR/BASEMENT INSTALLATION

Be aware of some special requirements if you place your spa indoors. Water will accumulate around the spa, so flooring materials must provide a good grip when wet. Proper drainage is essential to prevent a build-up of water around the spa. When building a new room for the spa it is recommended that a floor drain be installed. The humidity will naturally increase with the spa installed. Water may get into woodwork and produce dry rot, mildew, or other problems. Check for airborne moisture's effects on exposed wood, paper, etc. in the room. To minimize these effects, it is best to provide plenty of ventilation to the spa area. An architect can help to determine if more ventilation must be installed.

IMPORTANT: Your Tiger River spa is equipped with a vent to remove excessive heat from the equipment compartment. Find this vent (it's under the bottom right corner or both corners depending on the spa model) and be sure the vent is not blocked by anything, including carpeting.

Your Tiger River dealership can help you with local information such as zoning regulations and building codes. They can also give you a copy of our planning guide – just ask for Tiger River spa Pre-Delivery Instructions.

⚠ **WARNING:** Please keep the area around your spa well ventilated when it is installed indoors or in a confined area. Inadequate ventilation around the spa could cause a build-up of a higher-than-normal concentration of spa chemicals and/or bacterial fragments. These dispersed spa chemicals and/or bacterial fragments can be inhaled, and may result in breathing difficulties or lung damage in certain people suffering from a



compromised immune system or respiratory infection. If you or other bathers are affected by this condition, please seek medical attention as soon as possible.

In addition to the above, properly clean and maintain your spa as follows:

- Follow all procedures in this owner's manual and printed instructions on all water care (chemical) products packaging.
- Test the water regularly to ensure proper levels of sanitizers, pH, and other water care requirements.
- Drain, clean, and refill your spa with fresh water on a regular schedule, and in accordance with this owner's manual.
- Clean the filter(s) at least once per month.
- Check to make sure you have proper circulation throughout your spa water system.
- Have spa users bathe before entering the spa water.

SPA LEVELING INSTRUCTIONS

In order for your Tiger River® spa to operate properly, and the internal plumbing to drain completely, the spa must be level. If the spa is to be installed on an uneven, or unlevel foundation, shimming of the spa is required.

⚠ **WARNING:** Watkins Manufacturing Corporation recommends that a structural engineer or contractor be consulted prior to placing the spa on an elevated deck, or platform.

IMPORTANT: Watkins Manufacturing Corporation reserves the right to change any specifications or design without incurring any obligation.

Approved Shim Material

- Cedar shingles
- Exterior rated plywood
- Redwood
- Exterior rated lumber

The shims used should vary in thickness from 1/4 - to 1/2-inch (0.6 cm to 1.2 cm) and should be cut into 2" x 4" (5 cm x 10 cm) rectangles.

Leveling Instructions (Caspian™, Bengal® and Sumatran® models)

1. Using a 6' (2 meter) carpenter's level (or a shorter level and a straight 2" x 4", 8' board, or a board 5 cm by 10 cm, 2.4 meters long), check the spa to identify the highest, and lowest corners.
2. With one end of the level resting on the highest corner of the spa (and the opposite end resting on the lowest corner), gently raise the lower end of the level by placing shims between the spa shell and the level, until the level itself is level. This will tell you how many shims are needed at that lowest corner.
3. Now carefully pivot the level, keeping the shimmed end where it is, until the other end of the level rests on one of the other corners. Check the level. Adjust the end of the level using the procedure above. Carefully pivot the level again to the last corner, leaving the pivot end at its original location, and repeat the procedure. Whatever shims are on the three corners are the ones you will place under those corners in the next steps.
4. Remove the level and set it aside. Carefully remove the shims and keep them together, remembering the corner from which each set of shims came.
5. With more than one person lifting, lift the lowest side of the spa (the one with the most shims), and place a 4" x 4" (10 cm x 10 cm) block under the spa pedestal, at the center of the side lifted.
6. Refer to the spa pedestal diagram for your spa to locate the leveling points for the elevated corners. Place the set of shims corresponding to each corner directly under its designated leveling point.
7. Lift the spa, remove the support block, and set the spa on the shims. Repeat steps 5 through 7, if necessary, for the opposite side of the spa.
8. Use the level to check the level of the spa. Make any necessary adjustments.
9. Refer to the spa pedestal diagram for your spa to locate the remaining leveling points, each of which must now also be shimmed, and carefully slide "helper" shims under the spa at their designated locations. These helper shims should create a snug fit between the foundation and the spa's base structure. If it is necessary to lift the spa in order to place the helper shims, use care not to kick out the original corner shims.

The following base support diagrams for the Caspian, Bengal and Sumatran spas indicate the recommended shimming points.

Notice: Though designed for outdoor installation, your Tiger River spa is not impervious to damage that may be caused by insects, rodents, or other living creatures. (Per N.E.C., any metal surface must be grounded to the spa's terminal box. Please contact your dealership for additional information.) Please note, the electronics within the compartment need adequate airflow to cool the equipment and maintain the optimal temperature range. Sealing the opening completely, or allowing debris to build-up on the screen mesh, will adversely affect the spas' performance. Damage to the spa or it's components caused by an "act of nature", rodent or insect damage is not covered under the terms of your spa's Limited Warranty.

CASPIAN™ (MODEL CHP)

LEVELING POINTS

NOTE: All dimensions are approximate; measure your spa before making critical design or pathway decisions.

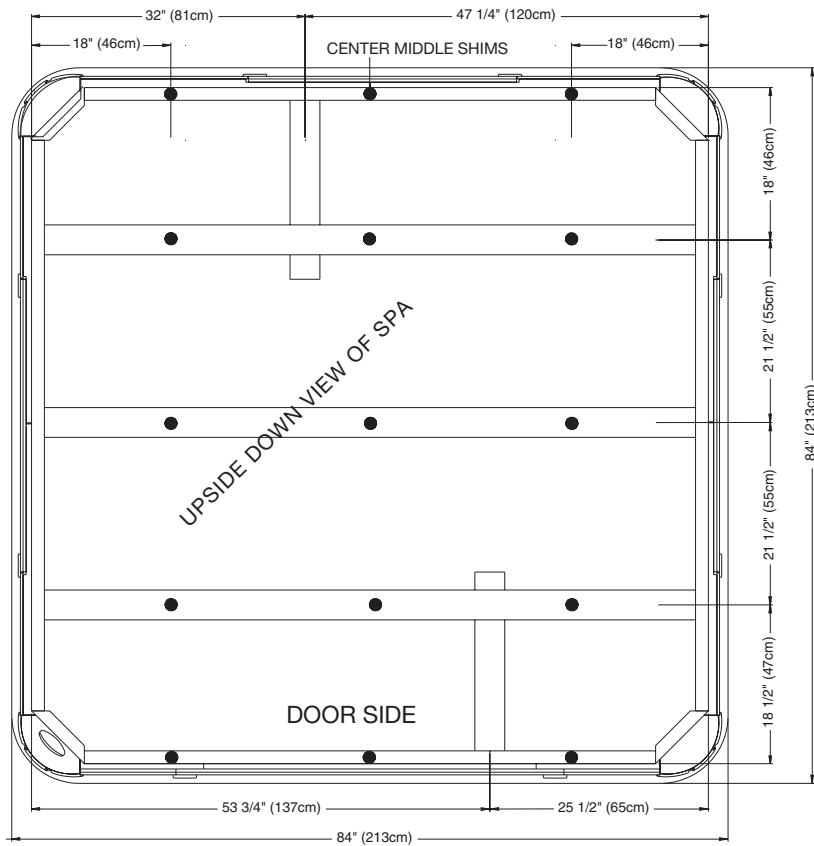

- 15 leveling points (place shims approx. 18" in from edge, then center middle shims)

BENGAL[®] (MODEL M / MM)

LEVELING POINTS

NOTE: All dimensions are approximate; measure your spa before making critical design or pathway decisions.

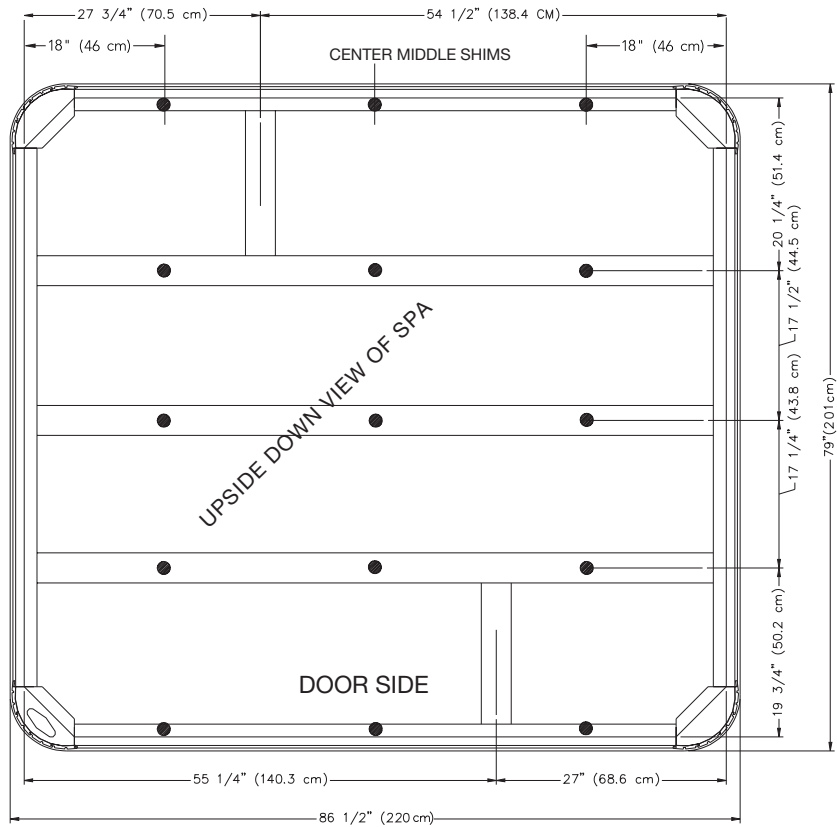

- 15 leveling points (place shims approx. 18" in from edge, then center middle shims)

SUMATRAN® (MODEL N)

LEVELING POINTS

NOTE: All dimensions are approximate; measure your spa before making critical design or pathway decisions.

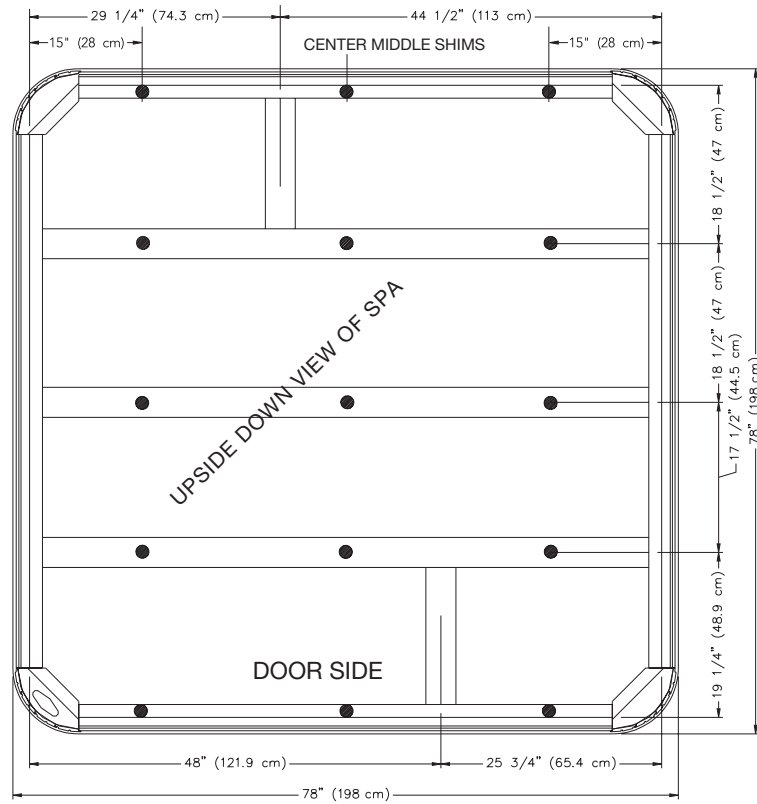

- 15 leveling points (place shims approx. 18" in from edge, then center middle shims)

CONTROLS AND EQUIPMENT

CASPIAN™ MODEL CHP

OVERHEAD VIEWS

- A. Hydromassage jet with directional nozzle
- B. Hydromassage jet with dual port rotary nozzle
- C. Precision® jets
- D. Heater return and spa drain
- E. Secondary suction
- F. Light lens
- G. Spa pillow
- H. Filter compartment
- I. Control panel
- J. Comfort Control® lever for Precision jets
- K. Cup holder
- L. Water Feature lever
- M. Water Feature



EQUIPMENT COMPARTMENT

- 1. Silent Flo 5000® circulation pump
- 2. Wavemaster® jet pump
- 3. No-Fault® heater
- 4. IQ 2020® spa control box
- 5. Main drain valve
- 6. Secondary drain
- 7. Ozone injector (optional accessory)
- 8. Bonding terminal

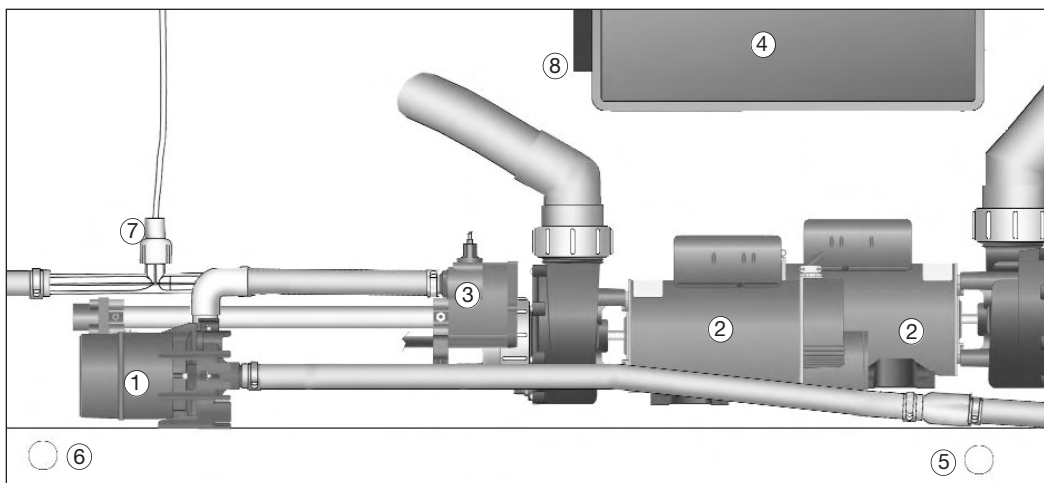

BENGAL® MODEL M / MM

OVERHEAD VIEWS

- A. Hydromassage jet with directional nozzle
- B. Hydromassage jet with dual port rotary nozzle
- C. JetStream® jet
- D. Precision® jets
- E. Heater return and spa drain
- F. Secondary suction
- G. Light lens
- H. Spa pillow
- I. Filter compartment
- J. SmartJet® system selector
- K. Control panel
- L. Comfort Control® lever for Precision jets
- M. Cup holder
- N. Water Feature (MM only)
- O. Water Feature Lever (MM only)



EQUIPMENT COMPARTMENT

- 1. Silent Flo 5000® circulation pump
- 2. Wavemaster® jet pump
- 3. No-Fault® heater
- 4. IQ 2020® spa control box
- 5. Light fixture (behind control box)
- 6. Main drain valve
- 7. Secondary drain valve
- 8. Ozone injector (optional accessory)
- 9. Bonding terminal

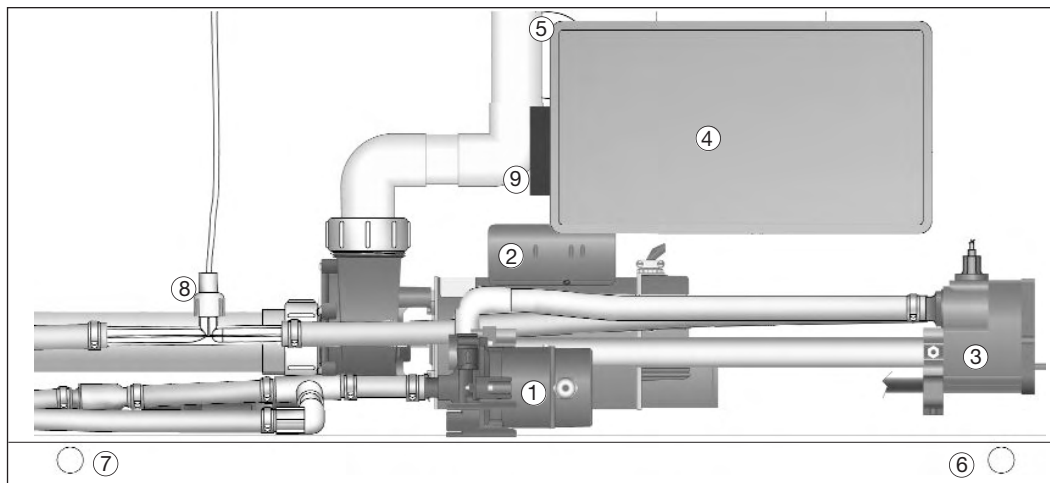

SUMATRAN® MODEL N

OVERHEAD VIEWS

- A. Hydromassage jet with directional nozzle
- B. Hydromassage jet with dual port rotary nozzle
- C. JetStream® jet
- D. Precision® jets
- E. Heater return and spa drain
- F. Secondary suction
- G. Light lens
- H. Spa pillow
- I. Filter compartment
- J. SmartJet® system selector
- K. Control panel
- L. Comfort Control® lever for Precision jets



EQUIPMENT COMPARTMENT

- 1. Silent Flo 5000® circulation pump
- 2. Wavemaster® jet pump
- 3. No-Fault® heater
- 4. IQ 2020® spa control box
- 5. Light fixture (behind control box)
- 6. Main drain valve
- 7. Secondary Drain
- 8. Ozone injector (optional accessory)
- 9. Bonding terminal

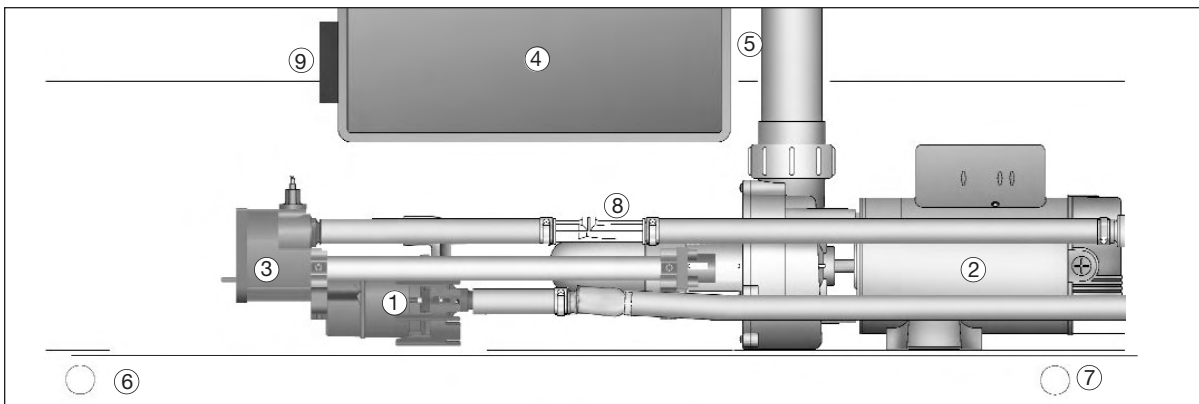

ELECTRICAL REQUIREMENTS AND PRECAUTIONS

Your Tiger River® spa has been carefully designed to give you maximum safety against electric shock. Connecting the spa to an improperly wired circuit will negate many of the spa's safety features. Improper wiring may also cause electrocution, risk of fire, and other risks of injuries. Please read and follow the electrical installation requirements and instructions for your specific spa model completely!

SERVICE NOTE: All Tiger River spa models are equipped with a power indicator which, in addition to showing the spa has power to it, has a diagnostic function as well. It will begin blinking if the heater high-limit thermostat has tripped. If the power indicator light is blinking, follow the instructions in the Troubleshooting section to identify and correct the cause. The power indicator will stop blinking once the problem has been corrected.

230 VOLT PERMANENTLY CONNECTED MODELS

- **CASPIAN™ (MODEL CHP)**
- **BENGAL® (MODEL MM)**

Electrical Requirements

TIGER RIVER SPAS MUST BE WIRED IN ACCORDANCE WITH ALL APPLICABLE LOCAL ELECTRICAL CODES. ALL ELECTRICAL WORK SHOULD BE DONE BY AN EXPERIENCED, LICENSED ELECTRICIAN. WE RECOMMEND THE USE OF APPROPRIATE ELECTRICAL CONDUIT, FITTINGS, AND WIRE FOR ALL CIRCUITS.

An electrical subpanel containing two GFCI breakers is included with each 230 volt spa. We recommend that this subpanel be used to supply power and protect the spa.

This subpanel requires a 50 amp, single phase, 230 volt, four wire service (two line, one neutral, one ground). The grounding conductor must be at least the same gauge as the line conductors, but not less than #10 AWG.

Mount the subpanel in the vicinity of the spa, but not closer than five feet away, in accordance with all local codes. (N.E.C. 680-38 to 41-A-3).

INSTALLATION INSTRUCTIONS

1. To connect the electrical service, first remove the screws from the equipment compartment door. Carefully pull the door panel away and down in order to remove it completely from the spa.
2. Locate the IQ 2020® spa control box. Loosen the screws on the front of the control box. Remove the screws and the control box cover.
3. Route the electrical service from the subpanel into the spa equipment compartment. Install the supply conduit so as not to block the drain valve.
NOTE: The subpanel must be placed in sight of the spa, at a minimum distance of five feet away.
4. Connect the supply conduit to the bottom of the IQ 2020 spa control box, using a 3/4" liquid-tight, flex conduit fittings.

CASPIAN (MODEL CHP) WIRING CONNECTIONS

1. Identify the TB-1 terminal block, located inside the control box at the lower left-hand corner.
 2. Connect the #12 AWG, BLUE wire, from the subpanel 20 amp breaker, terminal L1 to TB-1, terminal 1
 3. Connect the #12 AWG, RED wire, from the subpanel 20 amp breaker, terminal L2 to TB-1, terminal 3
- NOTE:** The WHITE neutral wire must be attached to the LOAD neutral on the 230 volt, 30 amp breaker (not to the neutral bus bar in the subpanel). The WHITE neutral wire coming from the breaker itself is already connected to the neutral bus bar.
4. Connect the #10 AWG, BLUE wire, from the subpanel 30 amp breaker, terminal L1 to TB-1, terminal 2
 5. Connect the #10 AWG, RED wire, from the subpanel 30 amp breaker, terminal L2 to TB-1, terminal 4
 6. Connect the #10 AWG, WHITE wire, from the subpanel 30 amp breaker, terminal N (load neutral) to TB-1, terminal 5
 7. Connect the #10 AWG, GREEN wire, from the subpanel GROUND bar to TB-1, system ground terminal.
 8. Using the pressure wire connector provided on the outside of the control box, bond the spa to all exposed metal equipment or fixtures, handrails, and the concrete pad (if applicable) per N.E.C. and local codes.
 9. Replace the control box cover and securely tighten the fastening screws. Close and secure the equipment compartment door as follows:
 - Place top of door or panel directly below bartop against the frame of the spa.
 - Push bottom of door or panel against the spa frame.
 - Slide door or panel upward (pushing in on center of door) until screw holes line up.
 - Slightly pull on door or panel, if door remains against the spa then replace the screws.
 - If the door does not lock into position, repeat the previous steps.

⚠ **WARNING: FILL THE SPA WITH WATER BEFORE TURNING ON THE POWER! (See STARTUP AND REFILL PROCEDURES).**

Once your spa has been filled with water, turn it on and test all of the circuit breakers.

NOTE: If both breakers immediately trip, verify that the #10 AWG WHITE neutral wire is connected from TB-1 terminal 5 to the N (load neutral) terminal of the 30 amp subpanel breaker. Each breaker should be tested prior to each use. Here's how:

1. Push the "TEST" button on each GFCI breaker, and observe it click OFF.
2. Wait 30 seconds, then push the breaker switch to the OFF (down) position (to ensure that it has completely disengaged), then push the breaker switch to the ON (up) position. If you don't wait 30 seconds, the spa's control panel may flash four lines on and off – try again.

If any of the GFCI breakers fails to operate in this manner, your spa may have an electrical malfunction, and you may be at risk of electrical shock. Turn off all circuits and do not use the spa until the problem has been corrected by an authorized service agent.

⚠ WARNING: Removing or bypassing any GFCI breaker will result in an unsafe spa and will void the spa's warranty.

IMPORTANT: Should you ever find the need to move or relocate your Tiger River® spa, it is essential that you understand and apply these installation requirements. Your Tiger River spa has been carefully engineered to provide maximum safety against electric shock. Remember, connecting the spa to an improperly wired circuit will negate many of its safety features.

NOTE: Long wiring runs may require larger-gauge wire than stated.

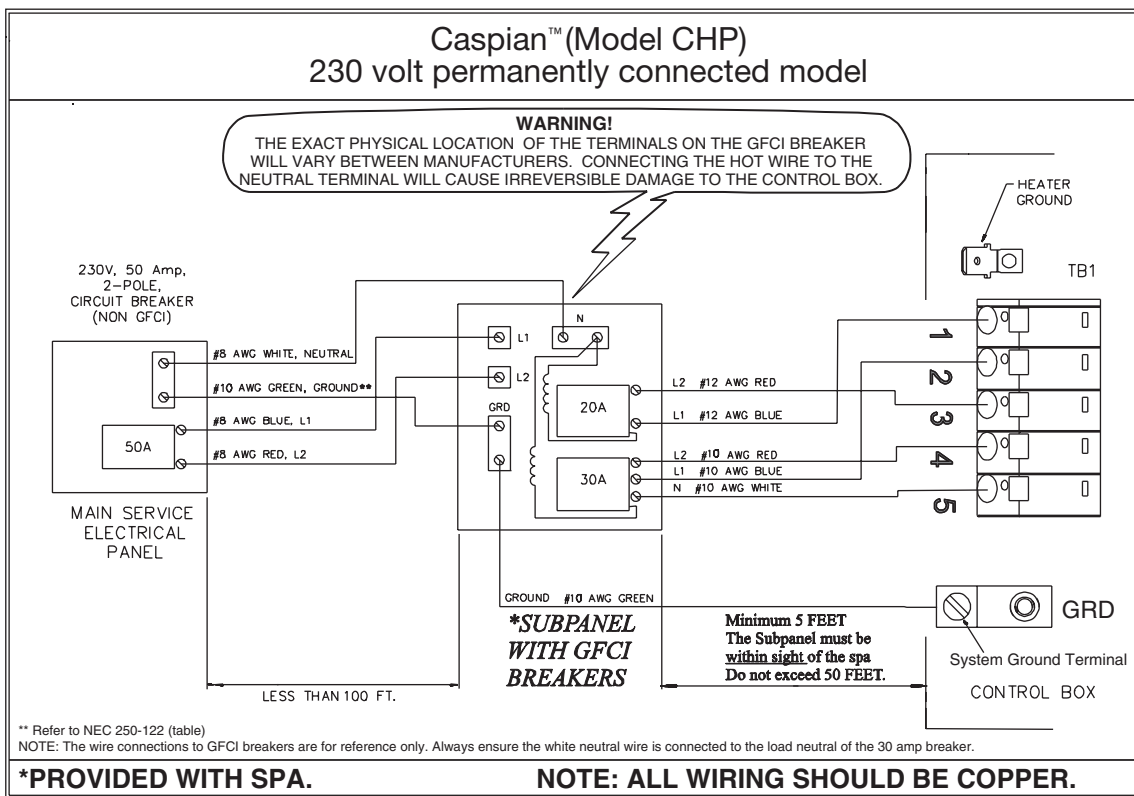

BENGAL® (MODEL MM) WIRING CONNECTIONS

1. Identify the TB-1 terminal block, located inside the IQ 2020® control box at the lower left-hand corner.
2. Connect the #12 AWG, BLUE wire, from the subpanel 20 amp breaker, terminal L1 to TB-1, terminal 2.
3. Connect the #12 AWG, RED wire, from the subpanel 20 amp breaker, terminal L2 to TB-1, terminal 4.
4. Connect the #12 AWG, WHITE wire, from the subpanel 20 amp breaker, terminal N (load neutral) to TB-1, terminal 5.

NOTE: The WHITE neutral wire must be attached to the LOAD neutral on the 230 volt, 20 amp breaker (not to the neutral bus bar in the subpanel). The WHITE neutral wire coming from the breaker itself is already connected to the neutral bus bar.

5. Connect the #10 AWG, BLUE wire, from the subpanel 30 amp breaker, terminal L1 to TB-1, terminal 1.
6. Connect the #10 AWG, RED wire, from the subpanel 30 amp breaker, terminal L2 to TB-1, terminal 3.
7. Connect the #10 AWG, GREEN wire, from the subpanel GROUND bar to TB-1, system ground terminal.
8. Using the pressure wire connector provided on the outside of the control box, bond the spa to all exposed metal equipment or fixtures,

Bengal® (Model MM) 230 volt permanently connected model

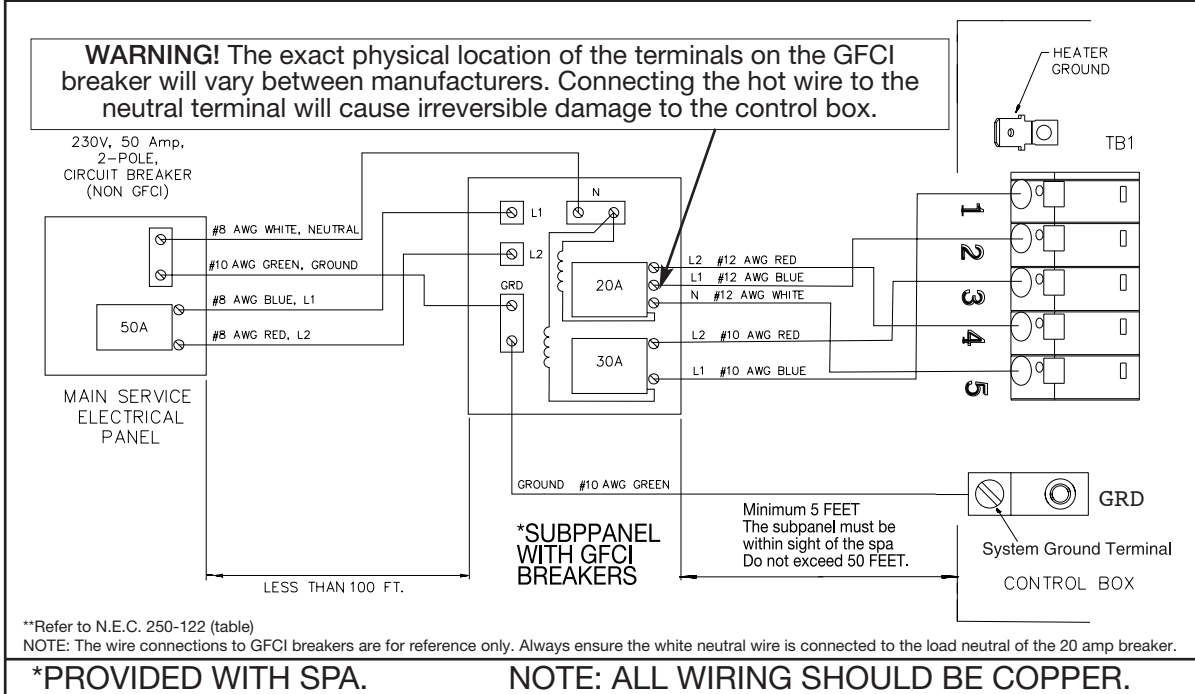

handrails, and the concrete pad (if applicable) per N.E.C. Article 680 and local codes.

9. Replace the control box cover and securely tighten the fastening screws. Close and secure the equipment compartment door.

⚠ WARNING: FILL THE SPA WITH WATER BEFORE TURNING ON THE POWER.

Once your spa has been filled with water, turn it on and test all of the circuit breakers.

NOTE: If both breakers immediately trip, verify that the #12 AWG WHITE neutral wire is connected from TB-1 terminal 5 to the L1 (load neutral) terminal of the 20 amp subpanel breaker. Each breaker should be tested prior to each use. Here's how:

1. Push the "TEST" button on each GFCI breaker, and observe it click OFF.
2. Wait 30 seconds, then push the breaker switch to the OFF (down) position (to ensure that it has completely disengaged), then push the breaker switch to the ON (up) position. If you don't wait 30 seconds, the spa's power indicator may continue to blink - try again.

If any of the GFCI breakers fails to operate in this manner, your spa may have an electrical malfunction, and you may be at risk of electrical shock. Turn off all circuits and do not use the spa until the problem has been corrected by an authorized service agent.

⚠ WARNING: Removing, or bypassing any GFCI breaker will result in an unsafe spa and will void the spa's warranty.

IMPORTANT: Should you ever find the need to move or relocate your Hot Spring® spa, it is essential that you understand and apply these installation requirements. Your Hot Spring spa has been carefully engineered to provide maximum safety against electric shock. Remember, connecting the spa to an improperly wired circuit will negate many of its safety features.

NOTE: Long wiring runs may require larger-gauge wire than stated. We recommend using a maximum 3% voltage drop when calculating wire gauge requirements.

115-230 VOLT CONVERTIBLE MODELS

BENGAL (MODEL M)

SUMATRAN® (MODEL N)

230 Volt Conversion Instructions

Refer to the following instructions to convert a 115 volt spa to a 230 volt spa.

NOTE: Converting the spa to 230 volt operation should only be done by an authorized service agent or a qualified electrician.

Required parts: (3) P.N. 36021 program jumpers (staged on JP jumpers in IQ 2020™ spa control box) and (1) P.N. 20679 or 37087 subpanel (230 volt)

1. Disconnect the power cord from the house receptacle.
2. Remove the screws and open the equipment compartment door.
3. Remove the screws on the front of the IQ 2020™ spa control box.
4. Open the control box cover.
5. Identify TB-1, located in the lower left-hand corner inside the control box.
6. Refer to Figure 1, item A. Remove both the 3 pin jumper attached to terminals 3, 4 and 5, and the 2 pin jumper attached to terminals 1 and 2.
7. Refer to Figure 1, item B. Remove the power cord wires from terminals 2, 4 and the system ground terminal.
8. Refer to Figure 1, item C. Attach the 2 pin jumper to terminals 4 and 5.
9. Unscrew the power cord strain relief and remove the power cord from the access hole in the control box.
10. On the large circuit board, locate the program jumpers, JP-1 through JP-12 (positioned near the center of the circuit board, with JP-1 being the top jumper).

⚠ **WARNING:** Do not allow pliers to contact any electronic components inside the control box.

11. Use a pair of needlenose pliers to place the program jumpers as shown in Figure 2 (use Watkins P.N. 36021).

NOTE: The program jumpers JP-1, JP-2 and JP-3 must be set correctly for the spa to operate. Figure 2 illustrates the correct jumper settings.

Converting from 115 volts to 230 volts changes the voltage supplied to the heater from 115 volts to 230 volts. The jet pump will continue to operate at 115 volts.

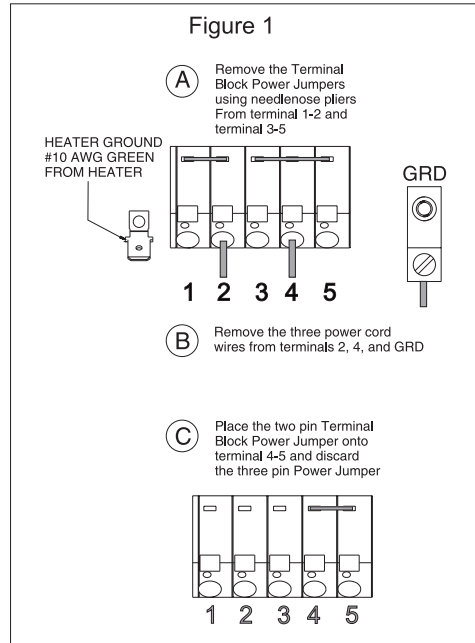

Installation Instructions

1. To connect the electrical service, first remove the screws from the equipment compartment door. Carefully pull the door panel away and remove it from the spa.
2. Locate the IQ 2020® spa control box. Loosen the screws on the front of the control box. Remove the screws and the control box cover.
3. Route the electrical service from the subpanel into the spa equipment compartment. Position the conduit in the recess provided between the frame and the door.

NOTE: The subpanel must be placed in sight of the spa, at a minimum distance of 5 feet away.

4. Connect the supply conduit to the bottom of the IQ 2020 spa control box, using a minimum of 3/4" liquid-tight, flex conduit fittings.

Wiring Connections

1. Identify the TB-1 terminal block, located at the lower left-hand corner of the control box.
2. Connect the #12 AWG, BLUE wire from the subpanel 20 amp breaker, terminal L1 to TB-1 terminal 2.
3. Connect the #12 AWG, WHITE wire from the subpanel 20 amp breaker, terminal N (load neutral) to TB-1, terminal 5.

NOTE: The WHITE neutral wire must be attached to the load neutral on the 115 volt, 20 amp breaker (not the neutral bus bar in the subpanel). The WHITE pigtail (neutral) wire from the 20 amp breaker is already connected to the neutral bus bar.

4. Connect the #10 AWG, BLUE wire from the subpanel 30 amp breaker, terminal L1 to TB-1, terminal 1.
5. Connect the #10 AWG, RED wire from the subpanel 30 amp breaker, terminal L2 to TB-1, terminal 3.
6. Connect the #10 AWG, GREEN wire from the subpanel ground bar to TB-1 system ground terminal.
7. Bond the spa to all exposed metal equipment or fixtures, handrails, and concrete pad per N.E.C. Article 680 and all local codes.
8. Replace the control box cover and securely tighten the fastening screws. Close and secure the equipment compartment door.

⚠ **WARNING:** FILL THE SPA WITH WATER BEFORE TURNING ON THE POWER.

Once your spa has been filled with water, turn it on and test all the circuit breakers.

NOTE: If both breakers immediately trip, verify that the #12 AWG WHITE neutral wire is connected from TB-1 terminal 5 to the L1 (load neutral) terminal of the 20 amp subpanel breaker. Each breaker should be tested prior to each use. Here's how:

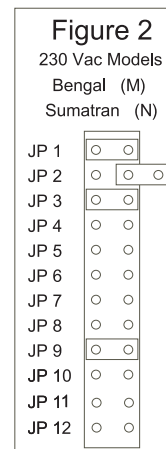

Bengal® (Model M) and Sumatran® (Model N) 230 volt converted models

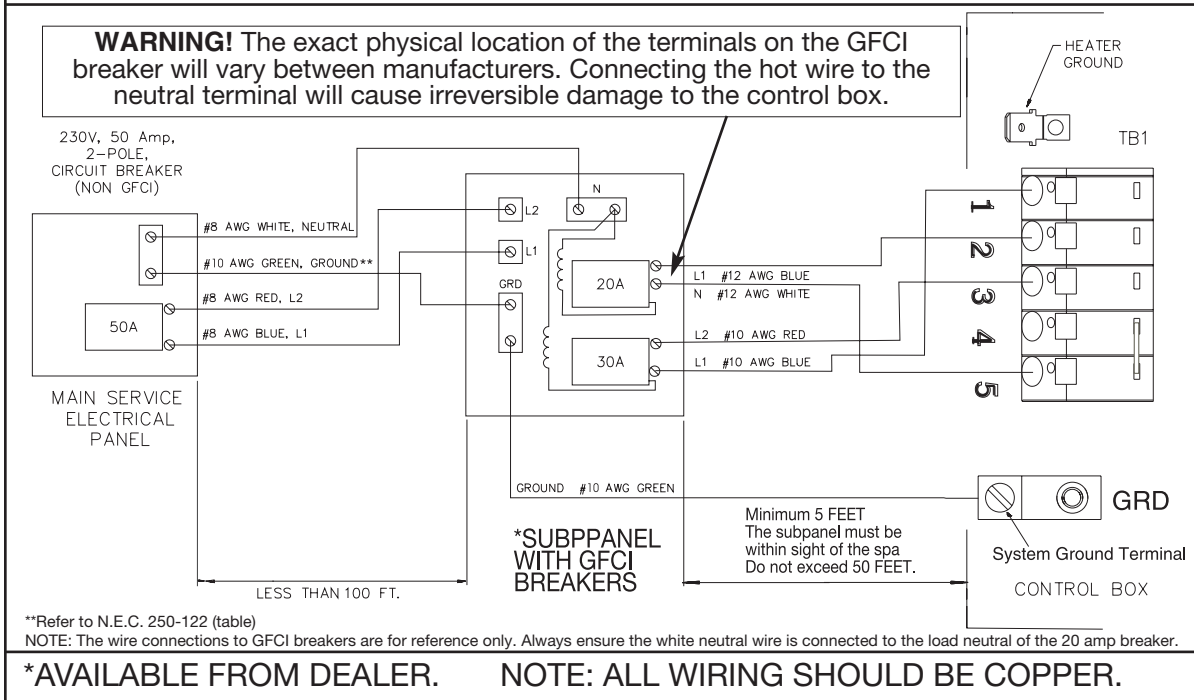

1. Push the "TEST" button on each GFCI breaker, and observe it click off.
2. Wait 30 seconds, then push the breaker switch to the OFF (down) position (to ensure that it has completely disengaged), then push the breaker switch to the ON (up) position. If you don't wait 30 seconds, the spa's power indicator may continue to blink – try again.

If any of the GFCI breakers fails to operate in this manner, your spa may have an electrical malfunction, and you may be at risk of electrical shock. Turn off all circuits and do not use the spa until the problem has been corrected by an authorized service agent.

115 VOLT OPERATION

The spa must be connected to a dedicated 115 volt, 20 amp, GFCI protected, grounded circuit. The term "dedicated" means the electrical circuit is not being used or shared for any other electrical items (patio lights, appliances, garage circuits, etc.). If the spa is connected to a non-dedicated circuit, overloading will result in "nuisance tripping" at the main panel. This requires frequent resetting of the breaker switch at the house electrical breaker panel and introduces the possibility of damage, or failure of spa equipment. The dedicated circuit must be properly wired; that is, it must have a 20 amp GFCI circuit breaker in the house breaker panel, #12 AWG or larger wire (including the ground wire) and the correct polarity throughout the circuit.

NEVER CONNECT THE SPA TO AN EXTENSION CORD!

A pressure wire connector is provided on the exterior surface of the control box, inside the spa. This is to permit the connection of a ground bonding wire between this point and any metal equipment, enclosures, reinforced concrete pad, pipe, or conduit within 5 feet of the spa (if needed to comply with local building code requirements). The bonding wire must be at least a #10 AWG solid copper wire.

Bond the spa to all exposed metal equipment or fixtures, handrails, and concrete pad per N.E.C. Article 680 and all local codes.

Installation Instructions

Both 115 volt Tiger River® spa models come equipped with approximately 15 feet of useable power cord (this is the maximum length allowed by Underwriters Laboratory and the National Electric Code). When the spa is installed, the power cord will come out of the bottom of the equipment compartment door. For your safety, when the electrician is installing the 20 amp single electrical outlet and waterproof cover, the outlet should be no closer than 5 feet and no farther than 10 feet from the spa [reference National Electrical Code 680-6a(1) and 680-41a].

The Ground Fault Circuit Interrupter (GFCI) is located at the end of the power cord. This device is for your protection. It is very important to protect

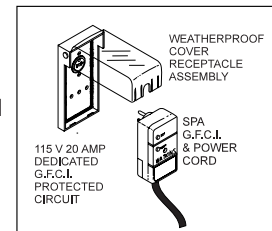
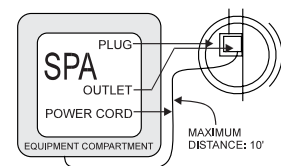

it from rain and other moisture. Once a month, with the plug connected to the power supply, test the GFCI in the following manner:

1. Push the "TEST" button on the GFCI breaker. The spa should stop operating and the GFCI power indicator will go out.
2. Wait 30 seconds, then push the "RESET" button. Power will be restored to the spa and the GFCI power indicator will turn on.

If the GFCI fails to operate in this manner, your spa may have an electrical malfunction, and you may be risking electrical shock. Turn off all circuits and do not use the spa until the problem has been corrected by an authorized service agent.

⚠ **WARNING:** Removal of the GFCI from the spa's power cord will result in an unsafe spa and will void the spa's warranty.

IMPORTANT: Should you ever find the need to move or relocate your Tiger River® spa, it is essential that you understand and apply these installation requirements. Your Tiger River spa has been carefully engineered to provide maximum safety against electric shock. Remember, connecting the spa to an improperly wired circuit will negate many of its safety features.

NOTE: Long wiring runs may require larger-gauge wire than stated. We recommend using a maximum 3% voltage drop when calculating wire gauge requirements.

OPERATING INSTRUCTIONS

Tiger River spas are manufactured in two different electrical versions, 230 volt permanently connected, and 115 / 230 volt convertible models. The Caspian™ and Bengal® (Model MM) spas are available only as 230 volt permanently connected models, and use a continuous heating system. This means that the heater may turn on while the jet pump is operating, unlike 115 volt models where the heater will automatically be turned off when the jet pump is turned on.

The remaining spa models, the Bengal (Model M) and Sumatran®, are available as 115v / 230v convertible systems, meaning that a 115 volt model can be converted to a 230 volt model. The benefit of operating in 230 volt mode is an increase in the wattage (heater capacity) of the heater, allowing the heater to run when the jet pump is operating, which keeps your water hotter longer when the jets are in use. **Contact your authorized Tiger River dealer for the requirements to convert between electrical systems at your home.**

IMPORTANT: Improper conversion from one system to another may damage the spa's electrical components. Always consult your authorized Tiger River dealer prior to converting from one electrical system to another.

230 VOLT PERMANENTLY CONNECTED MODEL

• CASPIAN (MODEL CHP) • BENGAL (MODEL MM)

The 230 volt permanently connected Caspian & Bengal (Model MM) comes with a subpanel which contains two GFCI circuit breakers - a 20 amp / 30 amp / 230 volt GFCI circuit breaker system. The subpanel and spa must be "hardwired" by a licensed electrician using appropriate wire, conduit, and fittings.

The Caspian model features one Wavemaster® 8000 (2 hp single speed) jet pump and one Wavemaster 8200 (2 hp two speed) jet pump. The Bengal (Model MM) features a Wavemaster 9200 (2.5 hp two speed) jet pump. The Caspian and Bengal (Model MM) spas have a No-Fault® titanium, high watt density heater. The heating system consists of a 4,000 watt (4 kW) heater on the Caspian while the Bengal (Model MM) has a 6000 Watts (6kW) heater. The spas are also equipped with an energy efficient low-flow circulation pump, and a high-limit thermostat for protection of user and equipment.

The heater will turn on while the jet pump is operating (after a 1-1/2 degree temperature drop) to help maintain the water temperature during spa use. Factors such as the number of people using the spa, the air temperature, and the length of time the pump is operated will affect the heating system's ability to maintain the water temperature.

115/230 VOLT CONVERTIBLE MODELS

• BENGAL (MODEL M) • SUMATRAN (MODEL N)

The 115 / 230 volt convertible Tiger River spa models come configured with a familiar 115 volt electrical system, with a GFCI plug at the end of a cord. The GFCI plug contains a GFCI breaker for user and equipment protection. The 115 volt configuration requires a dedicated outlet to supply power to the spa.

These models can be converted to 230 volt operation with the addition of a subpanel and a control box wiring change. Consult your dealer before attempting to convert from 115 volt operation to 230 volt operation. Any damage to the spa from improper conversion is not covered under the warranty.

In the 115 volt configuration, either the heater, or the jet pump can operate, but they can't work at the same time. In a 115 volt system, as long as the jet pump is activated, the heater will not turn on. On the other hand, when the spa is converted to operate in the 230 volt configuration, the heater and jet pump can operate simultaneously.

Each convertible spa model is equipped with a No-Fault titanium, high watt density heater. The heater will operate at 1500 watts when the spa is configured as a 115 volt cord-and-plug connected model, and at 6000 watts when the spa is configured as a 230 volt converted model. The heating system consists of the No-Fault heater, an energy efficient low-flow circulation pump, and a high-limit thermostat and integrated pressure switch for user and equipment protection.

The Bengal® (Model M) and the Sumatran® models use the Wavemaster® 7000 (1.65 hp single speed) jet pump to operate their jet systems. Both feature the Silent Flo 5000® circulation pump, which will run continuously (even when the jet pump is operating) as part of the 24-hour continuous filtration system.

START-UP AND REFILL PROCEDURES

Your Tiger River® spa has been thoroughly tested during the manufacturing process to ensure reliability and long-term customer satisfaction. A small amount of water may have remained in the plumbing after testing and, as a result, may have spotted the spa shell or the spa siding prior to delivery. Before filling the spa, wipe the spa shell clean with a soft rag.

The following instructions must be read and followed exactly to ensure a successful start-up or refill.

CAUTIONS

- Do not fill the spa with hot water, as tripping of the high-limit thermostat may result.
- **DO NOT CONNECT POWER TO AN EMPTY SPA.** Power to the spa automatically activates critical components within the spa, such as controls, heater, circulation pump, and other systems. If power is supplied to these components prior to the spa being filled, the components will be damaged, and this may result in a non-warranty component failure.
- Do not use your spa after filling until all of the steps listed below are completed.
- Do not add chlorine if treating your spa with polyhexamethylene biguanide (Biguanide, PHMB, eg. BaquaSpa™) sanitizer.
- Do not use the FrestStart®_{10,000} pre-filter if treating your spa with a polyhexamethylene biguanide (Biguanide, PHMB, i.e. BaquaSpa™) sanitizer.

1. Close all drains and fill the spa with water through the filter compartment. The water level of your Tiger River spa should be maintained just below the bottom of the pillow.

RECOMMENDED: Use the FreshStart_{10,000} pre-filter to remove unwanted contaminants from the tap water.

IMPORTANT: Watkins Manufacturing Corporation does not recommend that the spa be filled with “softened” water, as this may damage the spa’s equipment.

2. **AFTER** the spa has been filled with water and the equipment compartment door is secured, power must be applied to the spa.
 - **115 volt models:** Connect the GFCI to the waterproof receptacle and push the RESET button on the GFCI.
 - **230 volt models:** Open the door of the electrical subpanel and reset the 20 amp GFCI breaker (30 amp GFCI breaker for Caspian™ model only), verify that the system is primed (see step 3), then reset the 30 amp breaker (20 amp breaker for Caspian model). Close and secure the subpanel door.
3. The jet pump, heating system, and all internal plumbing will achieve a partial prime as the spa is filled. To check the operation of the jet system and to remove any remaining air from the heating system, push the JETS button (two times for Caspian) to make the jet pumps run on high speed, run for one minute. Once the jet system is fully operational (as indicated by strong, non-surfing jets), priming of the spa is complete. Weak or surfing jets are an indication of a low water level condition or clogged filter cartridges.

IMPORTANT: Be sure the air control valves (see illustration in Comfort Control® system section) are open by turning each one clockwise and checking to see that the SmartJet® lever is pointing to the 3 o’clock position (see illustration in SmartJet system section).

4. Adjust Total Alkalinity (TA) to 125 ppm, Calcium Hardness (CH) to 150 ppm, then spa water pH to between 7.4 and 7.6. These procedures are listed in the “Water Quality and Maintenance” section.

IMPORTANT: Add spa water chemicals directly into the filter compartment with the jet pump on high speed for at least ten minutes.

OPERATION NOTE: Adjusting the Total Alkalinity as the first step is important, as out-of-balance TA will affect your ability to adjust the pH correctly and will prevent the sanitizer from operating effectively.

5. Superchlorinate the spa water by adding 1-1/2 teaspoons of chlorine (sodium dichlor) per 250 gallons (950 liters) of spa water. Run the jet pump for a ten-minute period (clean cycle).
6. During the super-chlorination period, rotate the SmartJet lever(s) (not on the Caspian model) through each of their operating positions, letting the spa water circulate (with jets on) for equal periods of time. For example, if your spa has four operating positions, leave the SmartJet lever in each position for approximately two to three minutes.

OPERATION NOTE: The Sumatran lever is designed to operate in the 3 o’clock and 9 o’clock positions. The Bengal SmartJet lever is designed to operate in the 3 o’clock, 6 o’clock, 9 o’clock and 12 o’clock positions. Caspian does not have a SmartJet lever.

7. Set the temperature control to the desired temperature between 100°F and 104°F (36°C and 40°C), then place the vinyl cover on the spa and allow the water temperature to stabilize (approximately 24 hours). Make sure you secure the cover in place using the cover locks. Periodically check the spa water temperature. When the water temperature climbs above 90°F (32°C), proceed to the next step.
8. Rotate the SmartJet lever(s) to the primary position (3 o’clock) and turn on the jets for ten minutes to circulate the spa water. After the jets have run for ten minutes (clean cycle), test the spa water for Free Available Chlorine (FAC) residual. If the residual is between 3 and 5 ppm on the test strips (found in the test kit) go on to the next step. If the residual is less than 3 ppm, superchlorinate the spa water by adding 1-1/2 teaspoons of chlorine (sodium dichlor) per 250 gallons (950 liters) of spa water. Run the jet pump to circulate the spa water for a ten-minute period (clean cycle).
9. Rotate the SmartJet lever(s) to next position and let the spa water circulate (using the jet) for ten minutes. Test the spa water for Free Available

Chlorine (FAC) residual. If the residual is between 3 and 5 ppm on the test strips (found in the test kit) go on to the next step. If the residual is less than 3 ppm, superchlorinate the spa water by adding 1-1/2 teaspoons of chlorine (sodium dichlor) per 250 gallons (950 liters) of spa water. Run the jet pump to circulate the spa water for a ten-minute period (clean cycle). Repeat this procedure until all SmartJet lever operating positions have been tested.

10. Recheck the Total Alkalinity (TA) at 125 ppm, Calcium Hardness (CH) at 150 ppm, then spa water pH at between 7.4 and 7.6.

Operational Note: Make sure you adjust your Total Alkalinity first, as an out-of-balance condition will affect your ability to adjust the pH correctly, and will prevent the sanitizer from operating effectively. **The spa is ready for use when the spa water has circulated through each SmartJet® lever operating position and the chlorine level remains between 3 ppm and 5 ppm.**

11. The spa temperature is pre-programmed to reach 102°F (39°C), and will normally do so within 18 to 24 hours. You may raise the water temperature by pressing the TEMP (+) button on the control panel, or lower it by pressing TEMP (-) button. After a few hours, the water temperature will remain within 1-1/2 degrees of your selected temperature. To prevent tampering, you can lock your desired temperature setting. Refer to the Control Panel section for details.

NOTE: Allowing the jet pump to operate for long uninterrupted periods of time with the cover in place will cause a rise in the spa water temperature. All spas are equipped with a safety device to reduce the risk of component damage or personal injury, should the jet pump be left running continuously for a long period of time. After two hours of continuous operation, the jet pump controller will automatically turn off the jet pump.

SMARTJET SYSTEM

With your Tiger River® spa's exclusive SmartJet system hydromassage design, you can control the massaging action of your spa. Using the SmartJet lever, the jets are activated in sets, known as jet systems.

The Sumatran® and Bengal® (MM) models have two jet systems that are activated by turning the SmartJet lever(s) to the 3 or 9 o'clock position. On the Bengal (M) model, the SmartJet system lever controls four jet systems. To access a jet system, simply turn the SmartJet system lever to the 3, 6, 9 or 12 o'clock position (facing the spa) to access the four jet systems.

NOTE: The SmartJet system is not used on the Caspian™.

Please consult the jet system menus on the following pages to determine which jets are activated with each SmartJet lever position. Or just jump in and play – turn the lever and see what happens.

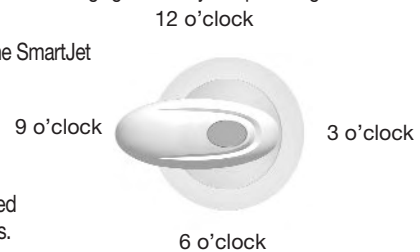

COMFORT CONTROL® SYSTEM

The Comfort Control system allows you to control the intensity of the Precision® jets by adjusting the mixture of air and water. Turn the Comfort Control lever clockwise to decrease the intensity of the Precision jets and counterclockwise to increase the intensity.



JETS

JETSTREAM® JETS

The JetStream jet is a large orifice hydromassage jet designed to put maximum massaging action on a specific area of the body. It is located in the lower part of the spa to afford optimal access for the massaging of feet, legs, hips, and lower back.

PRECISION® JETS

Precision jets are small, producing a precisely narrow stream of massaging action. They are placed in groups to perform a soft, soothing massage on your back, neck, and shoulders, or in the FootWell® system of the Caspian and Bengal spas as foot massagers.

HYDROMASSAGE JETS

The directional and rotary hydromassage jets are adjustable. The intensity of these jets is determined by the volume of air being induced into the jet chambers and mixing with the water stream. You have direct control of the intensity of the jet by rotating the jet faceplate either clockwise to decrease pressure, or counterclockwise to increase pressure.

The hydromassage jets have the option of two different nozzles (directional and dual port rotary). The directional nozzle allows you to aim the water in the direction that feels best. The dual port rotary nozzle divides the water flow into two streams, and then spins. Again, the faceplates on the rotary jets are used to change their intensity and speed of rotation. In addition to being adjustable, the rotary and directional jet nozzles are interchangeable. Simply grip the rotary or directional jet nozzle and pull it out of the jet retainer. Position the replacement nozzle at the desired jet location and push it into the retainer.

ACCESSORY NOTE: Your Tiger River dealer stocks hydromassage jet kits which can easily be installed in your spa to modify your jets from directional to dual port rotary.

Refer to the drawings on the following pages to familiarize yourself with the SmartJet system menus for your spa. Please note that the SmartJet system lever side of the spa is always considered the front when referring to the locations of the different types of jets and jet systems. **The clock positions are correct when facing the spa, standing at the SmartJet system lever.**

115 VOLT GFCI

The Ground Fault Circuit Interrupter is a safety device that is designed to detect as little as 5 milliamps ($\pm 1\text{mA}$) of electrical current leakage to ground. Watkins Manufacturing Corporation recommends that the GFCI be tested prior to each use to ensure that it is functioning correctly. With the spa connected to the power supply, push the TEST button. The spa should stop operating and the GFCI power indicator will go out. Wait 30 seconds and then reset the GFCI by pushing the RESET button. The GFCI power indicator will turn on, restoring power to the spa. If the interrupter does not perform in this manner, it is an indication of an electrical malfunction and the possibility of an electric shock. Disconnect the plug from the receptacle until the fault has been identified and corrected.

NOTE: Failure to wait 30 seconds before resetting the GFCI may cause the spa's Power indicator (on the control panel) to blink. If this occurs, repeat the GFCI test procedure.

CAUTION: Never use the GFCI as a means to disconnect power to the spa (always unplug it). If the GFCI is tripped while the spa is plugged in, and a power outage occurs, when power returns the GFCI will automatically reset and power will flow to the spa.

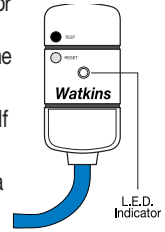

WATER FEATURE

(Available on the Caspian™ & Bengal (MM)® models only)

The Caspian and Bengal (MM) come equipped with the Amur® water feature. This water feature can be turned on or off when the two-speed pump is on low speed (tranquil mode) or high speed. To function correctly, the water feature on/off lever must be placed in the *full on* position only.

If the lever is not in the *full on* position when the pump is on high speed, it is likely that the water feature will project water substantially farther out into the spa as the on/off lever is opened. This is not proper operation. If this occurs, the pump should be turned off, the water feature lever rotated to the full on position and the pump turned on again.

CAUTION: Partial blockage of water flow at entrance of water feature will cause the water to flow farther into or over the spa.

CASPIAN™ (MODEL CHP)



Jet System 1 (Jet pump 2)

- 2 dual port rotary hydromassage jets on right back wall
- 6 Precision® jets in FootWell® system
- 13 Precision jets on back left
- 1 Water Feature (right wall) lever must be in ON position



Jet System 2 (Jet pump 1)

- 1 directional hydromassage jet on back wall
- 1 directional hydromassage jet on right back wall
- 2 directional hydromassage jets on right wall
- 4 Precision jets on front wall
- 1 directional hydromassage jet on front wall
- 6 Precision jets on left wall

BENGAL[®] (Model M)



Jet System 1

SmartJet[®] lever in the 3 o'clock position

- 10 Precision[®] jets on back left
- 1 directional hydromassage jets on back wall
- 2 dual port rotary hydromassage jets on back right
- 1 directional hydromassage jet on front wall
- 1 directional hydromassage jet on left wall



Jet System 2

SmartJet lever in the 6 o'clock position

- 10 Precision jets on back left
- 3 Jet-Cluster[™] system on back right (2 dual port rotary hydromassage jets, 1 directional hydromassage jet)
- 1 JetStream[®] jet on front right



Jet System 3

SmartJet lever in the 9 o'clock position

- 12 Precision jets on back left
- 2 directional hydromassage jets on back wall
- 6 Precision jets in FootWell[®] system
- 1 directional hydromassage jets on left wall



Jet System 4

SmartJet lever in the 12 o'clock position

- 12 Precision jets on back left
- 6 Precision jets in FootWell system
- 1 JetStream jet on front right
- 1 directional hydromassage jet on front wall

BENGAL[®] (Model MM)



Jet System 1

SmartJet[®] lever in the 3 o'clock position

- 12 Precision[®] jets on back left
- 1 directional hydromassage jets on back wall
- 2 dual port rotary hydromassage jets on back right
- 1 Water Feature (right wall) lever must be on
- 1 directional hydromassage jet on front wall
- 1 directional hydromassage jet on left wall



Jet System 2

SmartJet lever in the 9 o'clock position

- 2 Precision jets on back left
- 2 directional hydromassage jets on back wall
- 3 Jet-Cluster[™] system on back right (2 dual port rotary hydromassage jets, 1 directional hydromassage jet)
- 1 Water Feature (right wall) lever must be on
- 6 Precision jets in FootWell[®] system
- 1 directional hydromassage jets on front wall
- 1 directional hydromassage jet on left wall

SUMATRAN® (MODEL N)



Jet System 1

SmartJet® lever in the 3 o'clock position

- 2 dual port rotary hydromassage jets on back left
- 10 Precision® jets on back right
- 2 directional hydromassage jets on front left



Jet System 2

SmartJet lever in the 9 o'clock position

- 3 Jet-Cluster™ system on back left (2 dual port rotary hydromassage jets, 1 directional hydromassage jet)
- 1 JetStream® jet in FootWell® system

CONTROL PANEL OPERATIONS

CONTROL PANEL

All Tiger River® spa models are equipped with a control panel located on the bartop above the equipment compartment door. The control panel allows the user to set the temperature, activate the jets and light, and access menus to lock the temperature and/or spa functions, and uses indicator lights and an integrated LCD display to provide a quick visual check of the spa's status.

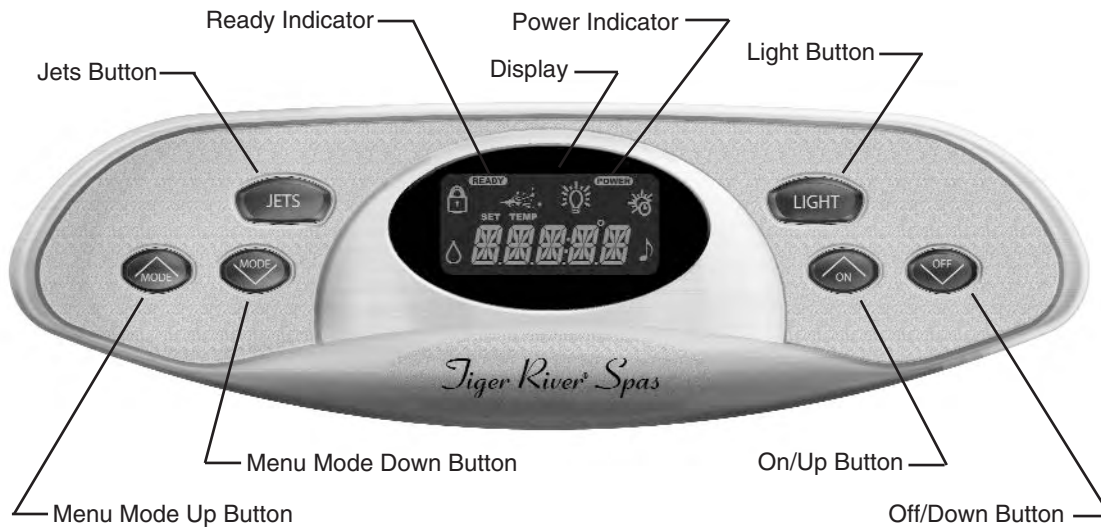

CONTROL PANEL BUTTON AND DISPLAY

The control panel has buttons which the spa user presses to set the temperature, turn the light on and off, activate or deactivate the jet pump and several other functions depending on what has been added to your spa. The control panel display responds to let you know you've pressed a button, and that the selected function has been performed. After a period of non-use, pressing any button will wake up a sleeping display, as well as performing its function. Function icons when in active mode will remain lit during the sleeping display.

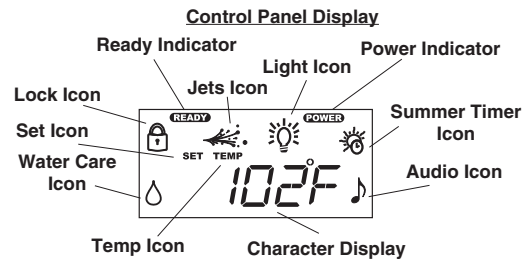
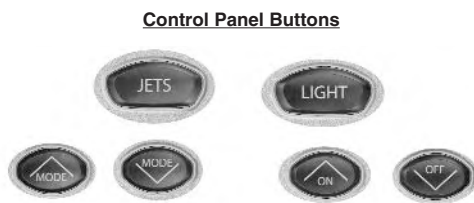

JETS CONTROL

The JETS button activates the jet pump. When the JETS button is pressed, the JETS symbol will illuminate on the control panel display. The symbol will remain lit until the button is pressed to turn off the jet pump, or after two hours of continuous operation when the pump is automatically shut off by the control system.

If the jet pump will not engage, make sure SPA LOCK is deactivated.

Pressing the JETS button operates the jets as follows:

CASPIAN™:

- 1st press = low speed of jet pump 2
- 2nd press = high speed of jet pump 2
- 3rd press = high speed of jet pump 1 & 2
- 4th press = high speed of jet pump 1 and low speed of jet pump 2
- 5th press = high speed of jet pump 1
- 6th press = jet pumps OFF

BENGAL® (M) & SUMATRAN®:

- 1st press = jet pump ON
- 2nd press = jet pump OFF

BENGAL (MM):

- 1st press = jet pump low speed
- 2nd press = high speed jet pump
- 3rd press = jet pump OFF

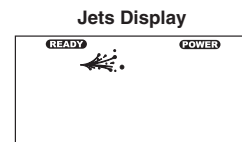

LIGHT CONTROL

The light control uses four positions: High, Medium, Low, and Off. To turn on the spa light, press the LIGHT button. This will place the light in the High, or maximum intensity position. When the light turns on, the light symbol will also illuminate on the control panel display. Press the LIGHT button again to lower the intensity of the light to the Medium position. Press the LIGHT button again to lower the intensity even more, placing the light intensity in the Low position. Press the LIGHT button one more time to shut the light off. When the light is deactivated, the light symbol will also turn off.

If the light is left on, it will automatically be turned off by the control system after 6 hours of continuous operation. The light symbol on the panel will also turn off when the light is deactivated.

If the light will not turn on, make sure SPA LOCK is deactivated. SPA LOCK disables the controls on the control panel.

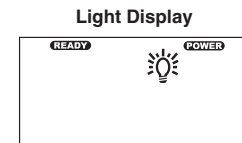

LIGHT

All Tiger River® spas come equipped with a light to enhance nighttime use. The spa uses a specially designed low voltage dimmable LED light source. If your spa is equipped with the optional multicolor light, follow the instruction card provided with the light for operation.

INDICATOR LIGHTS

At a glance, the indicator lights are readily visible on the main control panel. The two indicator lights (POWER and READY) work independently from the rest of the control panel display. That way, even if the control panel is off, you can simply glance at the "READY" indicator light to determine whether or not your spa is within the range of your set temperature.

Power indicator: The POWER indicator is 'on' when the spa is properly supplied with power. It also provides a diagnostic function – a blinking POWER indicator indicates that the heater high-limit has tripped, meaning that either the spa water is above its acceptable temperature range, or a malfunction has occurred within the spa (such as low circulation due to a clogged filter). An 'off' POWER indicator means that there is a problem with the spa control panel or the power supplied to the spa.

Ready indicator: The READY indicator will light when the spa water temperature is within 2-1/2°F of the set temperature, and will turn off when the temperature is outside of that range. If you increase or decrease the temperature setting of the spa, the READY indicator will turn off until the spa temperature reaches the acceptable range for the new set temperature. Additionally, a blinking READY indicator indicates that a problem exists with the temperature sensor.

CONTROL PANEL MENU DISPLAY

The control panel consists of four main menus. These menus are; Set Temperature, System, Lite+ and Tools. The Lite+ menu will only appear if the spa is equipped with an optional multicolor light (if equipped with the optional multicolor light, use the reference card provided with the light for operating instructions).

Press the MODE ▲ or MODE ▼ button to scroll through the main menus. Once the desired menu is illustrated, press the ON ▲ button to activate the menu.

TEMPERATURE CONTROL

The set temperature range is from 80°F to 104°F (27°C to 40°C). (The temperature of any setting may rise slightly depending on the current use and condition of your spa, and on outside temperature.)

The set temperature of the spa water will automatically be 102°F (39°C) the first time power is applied. This is the setting programmed at the factory. After the spa has been set up and used, the last temperature value set by the user will be stored in memory. If power is disconnected from the spa, it will automatically revert to the last set temperature when power is reapplied.

To display the set temperature of the spa, press the ON ▲ button. The set temperature will be displayed, unless the spa is locked (in which case the lock icon is displayed). The set temperature display will automatically shut off after 30 seconds.

To increase the set temperature of the spa water, press ON ▲ button. Each time the button is pressed, the set temperature display will increment by one degree. If the button is held down, the set temperature display will increase by one degree every half-second.

To decrease the set temperature of the spa water, press the OFF ▼ button. Each time the button is pressed, the set temperature display will decrement by one degree. If the button is held down, the set temperature display will decrease by one degree every half-second.

If the set temperature value will not change, check the TEMPERATURE LOCK and SPA LOCK features. When either of these features is applied, the temperature control is disabled. To activate the temperature control buttons, remove all locking features applied.

Set Temperature Display

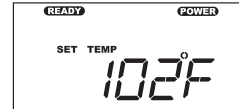

SYSTEM MODE

Your Tiger River® spa is equipped with a System Mode. This function will allow you to conveniently turn the jet(s) on high speed and the light on maximum intensity at the same time.

To activate the system mode, perform the following functions:

Press the MODE ▲ button until the SYSTM symbol is illuminated on the display. The jets and light icons will flash until the system mode is activated. Press the ON ▲ button to activate the SYSTM mode feature.

NOTE: Once activated, the jet and light functions can still be changed by pressing the JETS or LIGHT button.

To deactivate the system mode, press the MODE ▲ button until the SYSTM symbol is illuminated on the display. Press the OFF ▼ button to deactivate.

System Display Active

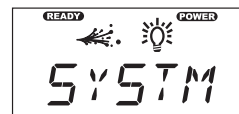

TOOLS MENU

The TOOLS menu is one of the main menus on the control panel. Within the TOOLS menu are six submenus, which consists of; Clean, Temp Lock, Spa Lock, Summer Timer and Exit.

To enter into the TOOLS menu, scroll through the main menus using the MODE ▲ or MODE ▼ button until the TOOLS menu is illustrated. Press the ON ▲ button to enter into the TOOLS submenu, use the MODE ▲ or MODE ▼ button to scroll through the submenus. Once the desired submenu is illustrated, press the ON ▲ button to activate the submenu or press the OFF ▼ button to deactivate the submenu. To leave the TOOLS submenu, scroll through the submenu until EXIT is illustrated, press the ON ▲ button to exit the submenu.

Tools Display



CLEANING MODE

All Tiger River spas are equipped with a "Cleaning" mode. When the mode is activated, the jet pump in the first jet system will turn on and run for ten minutes (used for water maintenance). To activate the "Cleaning" mode, press the MODE ▲ or MODE ▼ button until the TOOLS menu is illustrated. Then press the ON ▲ button to enter the TOOLS submenus. The CLEAN symbol will illuminated (the CLEAN mode is the first submenu) on the display. Press the ON ▲ button to activate the CLEAN mode feature.

NOTE: The jet icon will remain solid in the CLEAN display and will flash on and off in the main display while the "Cleaning" mode is active.

To stop the Cleaning Cycle before the ten minutes is complete, Press the MODE ▲ button until the TOOLS menu is illuminated then press the ON button to enter the TOOLS submenus where the CLEAN symbol is illuminated on the display. Press the OFF ▼ button to deactivate.

NOTE: Pressing the JETS button will also deactivate the clean cycle.

Clean Cycle Active



LOCKING FEATURES

The two locking features, SPA LOCK and TEMPERATURE LOCK, are enabled from the control panel by pressing the MODE ▲ or MODE ▼ button until the TOOLS menu is illustrated. Then press the ON ▲ button to enter the TOOLS submenus. Use the MODE ▲ or MODE ▼ button to scroll through the submenus to get to the locking features. Once enabled, a lock will remain active until the specific button combination is applied to disable the lock. Even if power is disconnected from the spa and soon thereafter reappplied (such as in a power outage) the lock will remain in place.

TEMPERATURE LOCK

The TEMPERATURE LOCK feature deactivates the temperature control function of the control panel. The jets and the light functions will operate normally. TEMPERATURE LOCK is most often used by people who do not want others to tamper with or change the set temperature of the spa water. TEMPERATURE LOCK is a submenu of the TOOLS menu

To activate the TEMPERATURE LOCK, press the MODE ▲ button in the TOOLS submenu until the LOCK + symbol is illuminated on the display. The lock icon will flash on and off when deactivated. Press the ON ▲ button to activate the TEMPERATURE LOCK feature.

When the TEMPERATURE LOCK is activated, the JETS, LIGHT and any other features your spa may have will operate normally, and the temperature setting can be viewed but can NOT be changed. If a temperature button is pressed, the control panel will display the lock symbol and the set temperature for 30 seconds, then turn off.

To deactivate the TEMPERATURE LOCK, press the MODE ▲ button in the TOOLS submenu until the LOCK - symbol is illuminated on the display. Press the OFF ▼ button to deactivate the TEMPERATURE LOCK feature.

Temp Lock Display

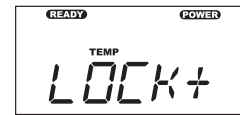

Temp Locked Display

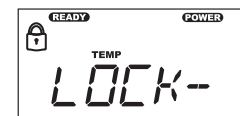

SPA LOCK

The SPA LOCK feature deactivates all of the functions of the control panel. It is generally used to prevent unwanted use of the spa. The SPA LOCK menu is a submenu of the TOOLS menu.

To activate the SPA LOCK, press the MODE ▲ button in the TOOLS submenu until the SPA + symbol is illuminated on the display. The lock icon will flash on and off when deactivated. Press the ON ▲ button to activate the SPA LOCK feature.

NOTE: When Spa is locked, any display other than SPA having a - or + after it will be replaced with an * after the word indicating the function is locked out. The * will only go away after the Spa is unlocked.

When the SPA LOCK is activated, the buttons for the jets, temperature control, light, and any other features your spa may have are deactivated. If a button is pressed, the control panel will display the lock symbol and the word SPA for 30 seconds, then turn off.

To deactivate the SPA LOCK, press the MODE ▲ button in the TOOLS submenu until the SPA - symbol is illuminated on the display. Press the OFF ▼ button to deactivate the SPA LOCK feature.

Spa Lock Display

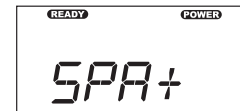

Spa Locked Display

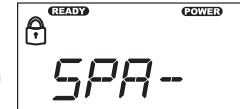

LOCK OVERRIDE

The Lock Override feature is for spa users who normally keep the set temperature locked. Should the user wish to lock all spa controls temporarily, the spa lock can be applied over an already-applied temperature lock. Then, when the spa lock is removed, the temperature lock will remain on to prevent unwanted tampering with the set temperature.

SUMMER MODE

Your Tiger River® spa is equipped with a Summer Mode timer. The Summer Mode timer can be activated during extremely hot summer months if it becomes difficult to maintain water temperatures low enough for comfort. Upon switching to the ON mode, the circulation pump (which can add heat to the water through normal operation) and heater will immediately shut down for the next eight hours. Additionally, the summer mode display on the control panel will activate and remain active for as long as the summer mode is on. Following this eight hour period, the circulation pump and heater will automatically re-start and will operate normally for the next sixteen hours. The circulation pump and heater will continue to turn off for an eight hour period every day that the timer remains in the ON position. In this way, the amount of heat transferred to the spa water will be minimized. When the outside temperatures begin to cool, the Summer Mode timer should be turned to the OFF position (the summer mode icon on the main display will shut off). This is the efficient 24 hour circulation mode that keeps the heater operation and operating costs to a minimum during colder/heavier usage months.

NOTE: Whenever power is disconnected and then reconnected to the spa, the Summer Mode timer will reset starting with the 8-hour shutdown mode. If a different eight-hour shut down time is desired, deactivate the Summer Mode, then reactivate at the beginning of the desired eight-hour shut down time.

IMPORTANT: The Summer Mode will not lower the spa's water temperature below the ambient air temperature.

To activate the Summer Mode, simply follow these steps:

1. Set the temperature control to 80°F (26°C) if desired to prevent the heater from turning on during cooler times.

Summer Mode Display



Summer Timer ON Display

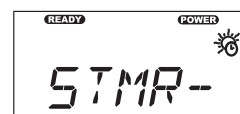

2. On the control panel press the MODE ▼ button until the TOOLS menu is illustrated. Then press the ON ▲ button to enter the TOOLS submenus. Press the MODE ▼ button until the STMR+ symbol is illuminated on the display. Press the ON ▲ button to activate the Summer Timer mode.

The Summer Mode must be deactivated when cooler temperatures return. To do this, simply follow step 3.

3. To shut the Summer Mode off, press the MODE ▼ button until the TOOLS menu is illustrated. Then press the ON ▲ button to enter the TOOLS submenus. Press the MODE ▼ button until the STMR- symbol is illuminated on the display. Press the OFF ▼ button to deactivate.

⚠ **WARNING:** Failure to deactivate or inadvertently activate the Summer Mode when the temperature drops below 32°F will result in freezing of the spa. Damage resulting from this situation is not covered under the terms of the limited warranty.

DISPLAY INVERSION

You may invert the control panel display for easier viewing from inside the spa.

To invert the display the following is required:

Press the “MODE ▼” & “OFF ▼” buttons simultaneously. By pressing the “MODE ▼” & “OFF ▼” buttons simultaneously a second time the screen will go back to it’s original display.

SPA CARE AND MAINTENANCE

Your Tiger River® spa is manufactured from the highest quality, most durable materials available. Even so, the spa care and maintenance program you develop will ultimately determine how long your spa, and its individual components, will last. Regular maintenance and following the advice in this section will help you to protect your investment.

DRAINING THE WATER

Detergent residues from bathing suits and soap film from your body may gradually accumulate in your spa’s water. Normally, in about four months the water will become sudsy and should be replaced. Showering without using soap prior to entering the spa, and using only the rinse cycle when laundering your bathing suit, will help to reduce detergent residue in the spa water. **IMPORTANT:** Remember to change your water every three to four months.

TO DRAIN YOUR SPA:

1. Disconnect the spa from the power supply by the appropriate method:
115 volt models - Disconnect the power cord from the house receptacle. Set the power cord in an elevated position so as not to allow water to enter the GFCI plug housing during draining of the spa.
230 volt models - Trip both of the GFCI breakers located in the subpanel.
2. Locate the main drain valve for the spa and remove the drain cap. Attach the inlet of a garden hose to the drain valve (to avoid flooding of the foundation surrounding the spa) and route the outlet of the hose to an appropriate draining area.
NOTE: Spa water with a high sanitizer level may harm plants and grass.
3. Open the valve by turning the knob. The spa will drain by gravitational flow.
IMPORTANT: All Tiger River spa models will drain almost completely through the main drain valve and the secondary drain. Equipment such as the jet pump and heating system will drain. Any water remaining within the plumbing or equipment after draining will only need to be removed if the spa is being winterized.
4. Allow all of the water to drain through the main drain.
5. Remove threaded cap from secondary drain (Bengal® and Sumatran® only). This will drain the remaining water (about one gallon) from the bleedline system.
6. When empty, inspect the spa shell and clean as required. (Follow the Care of the Exterior Finish instructions.)
7. Close the drain valve and reinstall the drain cap.
8. Reinstall threaded cap onto secondary drain.
9. Replace or close the equipment access door and replace the screws.
10. Refill the spa through the filter compartment BEFORE restoring power.

IMPORTANT: Always clean and rotate the filter cartridges each time the spa is drained for cleaning.

FILTER SYSTEM

The filter lid on the spa is NOT designed to support heavy weight loads and should not be used as a seat. In extreme cases, the lid could crack and break. This occurrence is considered abuse and is not covered under the warranty.

Tiger River® spas are equipped with one filter cartridge, sized to meet the needs of the jet pump system.

As with any water filtering system, the filter cartridges may become clogged, resulting in reduced water flow. It is important to maintain a clean, unobstructed filtering system. This not only provides the maximum performance from the jets, but allows the 24 hour filtration system to function effectively. *Watkins Manufacturing Corporation recommends the filter cartridges be cleaned (by soaking to dissolve minerals) at least once every month.*

⚠ **WARNING:** The frequency and duration of use, and the number of occupants, all contribute to determining the appropriate time between filter cleanings. More use means that more frequent filter cleanings are required. Failure to maintain the cartridges in a clean, unobstructed manner will result in reduced water flow through the heater assembly that may cause the High Limit Thermostat, Heater Thermal Cut-off or Circulation Pump Thermal Cut-off to trip. If this high limit or thermal cut-off trip occurs during sub-freezing temperatures and goes unnoticed, the spa water may freeze. Any damage to the spa (due to freezing) caused as a result of poor maintenance (stated under misuse or abuse in the Tiger River spa Limited Warranty), will not be covered by your spa warranty.

DANGER: To reduce the risk of injury to persons using the spa, DO NOT remove the suction fitting (filter standpipe) located in the filter compartment.

SECONDARY SUCTION SCREEN

Located in the footwell of your spa are one or two secondary suction screen(s), depending on your model. The screen is used as a filter to prevent dirt from circulating through the system.

⚠ **WARNING:** Do not use the spa with the suction screen(s) removed.

FILTER CARTRIDGE REMOVAL & CLEANING

1. Disconnect the spa from the power supply by the appropriate method:
115 volt models - Disconnect the power cord from the house receptacle. Set the power cord in an elevated position so as not to allow water to enter the GFCI plug housing during draining of the spa.
230 volt models - Trip both of the GFCI breakers located in the subpanel.
2. Remove and carefully set aside the filter compartment cover.
3. Remove any floating items from within the filter compartment.
4. Turn the filter retainer handle (located on the top of the filter cartridge) counterclockwise until the retainer can be removed from the filter standpipe.
5. Remove the filter retainer and cartridge.
SERVICE NOTE: Never remove the filter standpipe(s) when debris is present in the filter compartment. Debris may find its way into the internal plumbing which may result in blockage. NEVER REMOVE SUCTION FITTINGS!
6. Always clean the filter using a filter degreaser, such as Hot Spring® FreshWater® Filter Cleaner, to remove mineral and oil build-up. Simply soak the filter in the degreaser according to the package directions, then place the filter on a clean surface and spray until clean using a garden hose. It may be necessary to rotate the filter while spraying to remove any debris lodged between the filter pleats.
7. To reinstall the filter cartridge, reverse the order of steps in which it was removed. Do not overtighten

⚠ **WARNING:** Do not use the spa with the filter cartridge(s), or filter standpipe(s) removed!

CARE OF THE SPA PILLOWS

The spa pillows used in your Tiger River spa will continue to provide comfort if treated with care. They have been positioned above the water level to minimize the bleaching effects of chlorinated water, and other spa water chemicals. To extend their life, whenever the spa shell is being cleaned, the spa pillows should be removed and cleaned. Body oils can be removed with a mild soap and water solution. ALWAYS rinse off the spa pillows thoroughly to remove any soap residue. The pillows can be conditioned with Hot Spring Cover Shield after cleaning. If the spa is not going to be used for a long period of time (that is during a vacation, or if the spa is winterized), or when the spa water is being super-chlorinated, the spa pillows should be removed until the next spa use. Periodic replacement of the spa pillows will be necessary in order to maintain the new look of your spa.

To remove and replace the spa pillows:

1. Carefully lift one end of the pillow away from the spa shell.
2. Continue lifting one end until both pillow retainers are released from the pillow.
IMPORTANT: Just pulling the pillow straight up, and out of the shell recess, will eventually damage the pillow. This abuse is not covered under the limited warranty.
3. To reinstall the spa pillow, carefully bend the pillow slightly to allow one of the pillow retainers to slip into the recess in the back of the pillow.
4. Keeping the pillow slightly bent, slide the other pillow retainer into the recess in the back of the pillow.
5. After the second pillow retainer is in place, press the pillow down into the recess in the spa shell.

CARE OF THE EXTERIOR

SPA SHELL

Your Tiger River® spa has a granite-like or pearlescent shell. Stains and dirt generally will not adhere to your spa's surface. A soft rag or a nylon scrubber should easily remove most dirt. Most household chemicals are harmful to your spa's shell. Watkins Manufacturing Corp. recommends HotSpring® FreshWater® Spa Shine; the only other products which have passed the manufacturer's tests are Soft Scrub® and Windex®. Sodium bicarbonate (baking soda) can also be used for minor surface cleaning. Always thoroughly rinse off any spa shell cleaning agent with fresh water.

SERVICE NOTES:

1. Iron and copper in the water can stain the spa shell if allowed to go unchecked. Ask your Tiger River dealer about a Stain and Scale Inhibitor such as Hot Spring FreshWater Stain and Scale Defense to use if your spa water has a high concentration of dissolved minerals.
2. The use of alcohol or any household cleaners other than those listed to clean the spa shell surface is NOT recommended. DO NOT use any cleaning products containing abrasives or solvents since they may damage the shell surface. **NEVER USE HARSH CHEMICALS!** Damage to the shell by the use of harsh chemicals is not covered under the warranty.

IMPORTANT: Some surface cleaners contain eye and skin irritants. Keep all cleaners out of the reach of children and use care when applying.

SUREWOOD® SPA CABINET

Tiger River spas include a SureWood spa cabinet. SureWood consists of a rigid polymer that combines the durability of plastic, with the beauty of redwood. SureWood won't crack, peel, blister, or delaminate even after prolonged exposure to the elements.

Cleaning of SureWood consists of simply spraying the cabinet with a mild soap and water solution to remove any stains and residue.

Do not rub the SureWood with an abrasive material or use abrasive cleaners, as this may damage its texture.

Watkins Manufacturing Corporation recommends touch-up or restaining of the SureWood every three to four years (this will vary according to the environment). Contact your local dealer for restaining procedures and recommended stains.

CARE OF THE SPA COVER

⚠ **WARNING:** The vinyl cover is a manual safety cover that meets or exceeds all prevailing requirements of ASTM Standards for spa safety covers when installed and used correctly as of the date of manufacture. Non-secured, or improperly secured covers are a hazard. Open the cover to its fully open position before use.

VINYL COVER

The vinyl spa cover is an attractive, durable foam insulation product. Monthly cleaning and conditioning are recommended to maintain its beauty.

To clean and condition the vinyl cover:

1. Remove the cover from the spa and gently lean it against a wall or fence.
2. With a garden hose, spray the cover to loosen and rinse away dirt or debris.
3. Using a large sponge and/or a soft bristle brush, and using a very mild soap solution (one teaspoon dishwashing liquid with two gallons of water), or baking soda (sodium bicarbonate), scrub the vinyl top in a circular motion. Do not let the vinyl dry with a soap film on it before it can be rinsed clean.

IMPORTANT: To avoid soap getting into the spa water, the spa cover should not be on the spa during cleaning.

4. Scrub the cover's perimeter and side flaps. Rinse clean with water.
5. Rinse off the underside of the cover with water only (use no soap), and wipe it clean with a dry rag.
6. To condition the cover after cleaning, apply a thin film of Hot Spring Cover Shield to the vinyl surface and buff to a high luster.

SERVICE NOTE: To remove tree sap, use cigarette lighter fluid (not charcoal lighter fluid). Use sparingly, and rinse with saddle soap solution immediately afterwards, then wipe dry.

Important reminders:

- **DO** remove snow buildup to avoid breakage of the foam core from the additional weight of the snow.
- **DO** lock cover straps to secure the cover when the spa is not in use.
- **DO NOT** drag or lift the spa cover using either the flaps, or the tie-down straps.
- **DO NOT** walk, stand, or sit on the cover.
- **DO NOT** place any metal or heat transferring object on the cover or place any type of plastic tarp or drop cloth over the cover as this may result in a melted foam core, which would not be covered under the warranty.
- **DO NOT** use any lifting mechanisms, chemicals, or cleaners except those recommended by Watkins Manufacturing Corporation, or its Authorized Sales and Service Dealer.

IMPORTANT: Whenever the spa is not in use, it is essential that the cover be in place. When filled, this ensures effective temperature maintenance and economical operation. When empty, this prevents potential damage to the surface finish of the interior walls, which can result from the excessive heat of the sun. This type of damage is specifically excluded from warranty coverage.

RETRACTABLE COVER SYSTEM

Clearance required behind cover when open: • CoverCradle® & CoverCradle II - 24" • UpRite® - 7" • GlideRite® - 14" • Lift 'n Glide® - 7"

HOW TO OPEN THE VINYL COVER

NOTE: Never attempt to open or remove the vinyl cover by grasping or pulling on the skirting or cover lock straps. The skirting will tear, and torn skirting is not covered under the terms of the warranty.

Check for ice build-up around the gas springs and pivot points of the retractable cover system. Ice buildup may damage system components.

⚠ **WARNING:** The vinyl cover and retractable cover system are not recommended for use in wind conditions reaching above 25 mph (40 kmh).

NOTE: If your spa is located in an area susceptible to high winds, additional cover lock straps may be installed to minimize wind damage to the cover.

How to Open the Cover

1. With the cover lock straps unfastened, place one hand under the cover skirting, between the spa and cover, to break the cover's vacuum seal. Then, fold the front half of the cover over onto the back half.
2. If no rear access is available, stand to the side of the spa directly adjacent to the hinge area of the folded cover.
 - A. **For the CoverCradle & CoverCradle II retractable cover systems:** Using both hands, cup one hand under the lower half of the cover (just above the water) and place the other along the side of the cover, just above the skirt. Gently push (do not lift) with both hands towards the opposite rear corner of the cover (diagonally). As the cover opens, the gas springs will allow the cover to come to a gentle stop.
 - B. **For the UpRite or GlideRite retractable cover systems:** Simply lift the cover at its center hinge, allowing it to move to the back of the spa and to gently rest there.
 - C. **For the Lift 'n Glide retractable cover system:** Slightly lift the cover at front of spa, glide (push back till it stops), fold cover in half and lift cover moving it to the back of the spa. Insert locking pin into side of lifter to prevent accidental closure.

NOTE: When opening a cover with a retractable cover system, only use one of these three specific methods. Do not attempt to open the cover in any other way. Damage caused by improper opening or closing of the cover is not covered under the terms of the limited warranty.

How to Close the Cover

1. Standing along side the cover, place one hand on the upper corner of the cover and gently push forward in the direction of the spa. The cover will rotate forward to cover half of the spa.

NOTE: For the UpRite, GlideRite or Lift 'n Glide retractable cover system, disengage the locking mechanism(s) before pushing the cover forward.
2. Unfold the cover by lifting the handle located on the top (front) half of the cover. Allow the unfolded half to fall down onto the spa. The air pressure created by the cover falling will keep the vinyl skirting from being trapped between the cover and the spa shell.
3. Secure the cover lock straps to the spa and lock them.

Important reminders:

- **DO** always practice safety around your spa.
- **DO** unlock and release all cover locks before attempting to open cover.
- **DO** lock the cover when the spa is not in use.
- **DO** cover the spa with the vinyl cover when the spa is not in use, whether it is empty or full.
- **DO** remove snow build-up to prevent vinyl cover damage.
- **DO** keep the cover open during super-chlorination or shock treatment of the spa water.
- **DO NOT** walk, stand, climb, or sit on the vinyl cover or retractable cover system.
- **DO NOT** lift the cover or operate the retractable cover system by using the cover locks. They are not designed to be used as handles.
- **DO NOT** use any chemicals or cleaners except those recommended by Watkins Manufacturing Corporation, or its Authorized Sales and Service Dealer.
- **DO NOT** use hard, sharp, or metal objects, such as a car windshield scraper, to remove ice. Such objects can cut, mar, or puncture the vinyl surfaces.

⚠ **WARNING:** Keep unsupervised children away from the cover. Always lock the cover in place after use! Keep hands away from the hinging points. Do not allow anyone to climb, sit, or stand on the cover when in the open position. Injury may occur, as well as damage to the cover and mechanism.

VACATION CARE INSTRUCTIONS

If you plan to be away from home, follow these instructions to ensure that the water quality of your spa is maintained:

SHORT TIME PERIODS (3-5 DAYS):

1. Adjust the pH by following the instructions outlined in the Water Quality and Maintenance section.
2. Sanitize the water by following the shock procedures also listed in the Water Quality section.
3. Lock your cover in place using the cover lock straps.
4. Upon your return, sanitize the water by following the shock procedures, and balance the pH.

LONG TIME PERIODS (5-14 DAYS):

Prior to leaving:

1. At least one day before you leave, set the temperature to its lowest level. This setting should be 80°F (26°C).
IMPORTANT NOTE: Spa water oxidizers such as sodium dichlor (chlorine) maintain their level of effectiveness substantially longer in warm water (80°F, or 26°C) than in hot water (101°F to 104°F, or 38°C to 40°C).
2. Adjust the pH as required. Sanitize the water by following the shock procedures.

Upon your return:

3. Sanitize the water by following the shock procedures. Return the set temperature to its original setting. The spa water will be safe for you to use once the Free Chlorine Residual level has dropped below 5.0 ppm.

NOTE: If you will not be using your spa for an extended period of time (in excess of 14 days) and an outside maintenance service (or neighbor) is not available to assist with the water maintenance, draining or winterizing of the spa is recommended. Spas equipped with our FreshWater® III ozone system can extend this to 4 weeks. The FreshWater III ozone system does not guard against possible freezing damage, however.

PREVENTION OF FREEZING

Your Tiger River® spa has been designed and engineered for year-round use in any climate. In some areas, extremely cold temperatures (below 10°F, or -23°C), combined with strong wind, may cause partial freezing of the jet pump, even though the water inside the spa remains at the selected temperature. The energy efficiency of the spa may also decrease during these cold periods, as the heater will cycle more frequently. To avoid most problems associated with component freezing, the 24-hour continuous filtration system has been designed with bleed lines connecting the jet pump with the heating/filtering system. Since the heating system's circulation pump runs continuously, cooler water in the heating and filtering systems is continually being replaced by warm water from the spa. As an additional precaution against partial freezing of some of the components, the equipment compartment can be insulated with an insulating kit (available from your Tiger River dealer). This insulating kit will also help to maximize the spa's energy efficiency.

NOTE: When warmer weather returns (approx. 60°-70°F, or 16°-21°C), the insulating kit must be removed to prevent overheating of the jet pump.

Please contact your Tiger River dealer for additional information, or to order the insulating kit .

WINTERIZING

In very cold weather you may not want to venture outside to use your spa. In this case, you may move it to a heated area, or leave it as is until the weather warms. If you do leave the spa unused for a long period of time in severely cold weather, you should drain the spa to avoid accidental freezing due to a power or equipment failure.

IMPORTANT: The following steps should protect your spa from freezing damage provided these instructions are followed exactly. For maximum protection against freeze damage to your spa, Watkins Manufacturing Corporation recommends contacting your local Tiger River dealer to schedule an in-home Propylene glycol (anti-freeze) Winterizing Service plan. If the following instructions are not followed, damage due to freezing water in the plumbing lines may occur! **THIS DAMAGE MAY VOID YOUR WARRANTY.**

Your local authorized dealer can perform the following winterizing steps if you do not wish to attempt them yourself:

1. Disconnect the spa from the power supply by the appropriate method:
115 volt models: Disconnect the power cord from the house receptacle, coil it and place it in the equipment compartment.
230 volt models: Trip both of the GFCI breakers located in the subpanel.
2. Remove the screws from the equipment access door; remove the door completely (for 115 volt models only).
3. Locate the main drain valve and remove the drain cap. Attach a garden hose to the drain valve and route the outlet of the hose to an appropriate draining area.
4. Open the valve and the spa will drain by gravitational flow.
5. Remove the threaded cap from the secondary drain. The remaining water (about 1 gallon) will drain from the bleedline system.
6. Remove the filter cartridge, then clean and store the cartridge in a dry place.

IMPORTANT: Wipe out any residual water from inside the spa and the recesses of the filter compartment. Wipe all surfaces dry.

7. Close the cover. If your spa has a vinyl cover, cover it with a large board to help evenly distribute the weight of snow and ice.

SERVICE NOTES:

- Leave the main drain valve open approximately 1/4 turn during the winterizing months.
- To completely drain the internal plumbing, a wet/dry shop vac should be used to draw any remaining water through the drain and through each jet opening.

To Reactivate:

Reinstall the filter cartridge, close the main drain, and reinstall the drain caps. Follow the Start-Up and Refill Procedures to make your Tiger River® spa operational.

IMPORTANT: Always keep spa covered when not in use (whether it is empty or full).

WATER QUALITY AND MAINTENANCE

It's important to have clean water. Water maintenance is one of the least understood, yet most important areas of spa ownership. Your dealer can guide you through the process of achieving and maintaining perfect water in your spa, given your local conditions; here is our suggested step-by-step program.

Your program will depend on your water's mineral content, how often you use your spa, and how many people use it.

Watkins has developed the EverFresh® water care system for its spas, which is an alternative to using an entirely chlorine-based system. This system uses silver ions, ozone, and an oxidizer (monopersulfate or MPS) and dichlor to sanitize the spa. It includes the FreshStart®_{10,000} pre-filter, the FreshWater® III high output ozone system, and the FreshWater_{AG+}® silver ion purifier.

GENERAL INFORMATION

THE THREE FUNDAMENTAL AREAS OF WATER MAINTENANCE:

- **Water Filtration**
- **Chemical Balance/pH Control**
- **Water Sanitation**

Water sanitation is the responsibility of the spa owner, achieved through the regular and periodic (daily, if necessary) addition of an approved sanitizer. The sanitizer will chemically control the bacteria and viruses present in the fill water or introduced during use of the spa. Bacteria and viruses can grow quickly in undersanitized spa water.

The water's chemical balance and pH control are also the responsibility of the spa owner. You will have to add chemicals to maintain proper levels of Total Alkalinity (TA), Calcium Hardness (CH) and pH. Proper water balance and pH control will minimize scale buildup and metal corrosion, extend the life of the spa, and allow the sanitizer to work at maximum efficiency.

METHODS FOR TESTING THE SPA WATER

Accurate water testing and analysis are important parts of effectively maintaining your spa water. You must have the ability to test for:

- Total Alkalinity (TA)
- Calcium Hardness (CH)
- pH
- Sanitizer

Two types of testing methods are recognized and recommended by Watkins:

The Reagent Test Kit is a method which provides a high level of accuracy.

Test Strips are a convenient testing method used by many spa owners. Keep in mind that test strips are susceptible to heat and moisture contamination, which will result in inaccurate readings.

IMPORTANT: Always read and carefully follow the directions included with the Test Kit or Test Strips to ensure the accuracy of the test results.

BASIC CHEMICAL SAFETY

When using chemicals, read the labels carefully and follow directions precisely. Though chemicals protect you and your spa when used correctly, they can be hazardous in concentrated form. Always observe the following guidelines:

- Allow only a responsible person to handle spa chemicals. **KEEP THEM OUT OF THE REACH OF CHILDREN AND PETS.**
- Accurately measure the exact quantities specified, never more. Do not overdose your spa.
- Handle all containers with care. Store in a cool, dry, well ventilated place.
- Always keep chemical containers closed when not in use. Replace caps on their proper containers.
- Don't inhale fumes, or allow chemicals to come in contact with your eyes, nose, or mouth. Wash your hands immediately after use.

- Follow the emergency advice on the product label in case of accidental contact, or if the chemical is swallowed. Call a doctor or the local Poison Control Center. If a doctor is needed, take the product container along with you so that the substance can be identified.
- Don't let chemicals get on surrounding surfaces or landscaping. Don't use a vacuum cleaner to clean up chemical spills.
- Never smoke around chemicals. Some fumes can be highly flammable.
- Don't store any chemicals in the spa equipment compartment.

HOW TO ADD CHEMICALS TO THE WATER

IMPORTANT: All spa water chemicals, including granulated dichlor, MPS, granulated pH increaser or decreaser, granulated total alkalinity increaser, calcium hardness increaser, liquid stain and scale inhibitor, and liquid defoamer must always be added directly into the filter compartment while the jet pump is running in high speed mode, and it must run for a minimum of ten minutes.

To Administer Spa Water Chemicals:

1. Fold back the cover. Carefully remove and set aside the filter compartment cover.
2. Push the JETS button to turn on the jet pump.
3. Carefully measure the recommended amount of chemical and slowly pour it into the filter compartment. Use care not to splash chemicals on your hands, in your eyes, on the spa shell surface, or on the cabinet.
4. After ten minutes, turn the jet pump off, and close and secure the cover to complete the procedure.

Risk of Drowning: Never leave an open spa unattended!

IMPORTANT "SUPER CHLORINATION/NON-CHLORINE SHOCK TREATMENT" NOTE: After administering a super chlorination treatment or non-chlorine shock to your spa, leave the cover open for a minimum of 20 minutes to allow the oxidizer gas to vent. A high concentration of trapped oxidizer gas which may exist as a result of the shock treatment (not daily sanitation) may eventually cause discoloration or vinyl degradation to the bottom of the cover. This type of damage is considered chemical abuse and is not covered under the terms of the limited warranty.

WARNING: High sanitizer levels can cause discomfort to the user's eyes, lungs, and skin. Always allow the sanitizer level to fall to the recommended range before using the spa.

THE TIGER RIVER® SPA WATER MAINTENANCE PROGRAM

Each step in your water maintenance program is dependent on the completion of the previous steps. Omitting a step, or failing to reach the recommended range may cause an imbalance in your water chemistry. Unbalanced water chemistry can damage the spa, and its components, as well as cause discomfort for the user.

FILLING THE SPA WITH WATER

- A. Watkins Manufacturing Corporation recommends using the FreshStart[®]_{10,000} pre-filter when filling the spa (through the filter compartment) with water.
- ⚠ **WARNING:** DO NOT use the FreshStart_{10,000} pre-filter if you plan to use granular bromine or BaquaSpa™ as your sanitizer.
- B. The FreshStart_{10,000} pre-filter is designed to remove unwanted contaminants such as rust, dirt, detergents, and algae from the fill water. Dissolved minerals and metals such as lead, calcium, copper, and iron are not removed.
 - C. Instructions are included with the FreshStart_{10,000} pre-filter. When the spa is filled, proceed to the next step.

BALANCING THE TOTAL ALKALINITY (TA)

- A. The recommended Total Alkalinity (TA) for your spa water is 125-150 ppm.
- B. Total Alkalinity is a measure of the total levels of carbonates, bicarbonates, hydroxides, and other alkaline substances in the water. TA is referred to as the water's "pH buffer". In other words, it's a measure of the ability of the water to resist changes in pH level.
- C. If the TA is too low, the pH level will fluctuate widely from high to low. Fluctuations in pH can cause corrosion or scaling of the spa components. **Low TA can be corrected by adding Hot Spring FreshWater® pH/Alkalinity Up, or sodium hydrogen carbonate.**
- D. If the Total Alkalinity is too high, the pH level will tend to be high and may be difficult to bring down. **It can be lowered by adding Hot Spring FreshWater pH/Alkalinity Down, or sodium bisulfate.**
- E. Once the TA is balanced, it normally remains stable, although the addition of more water with a high or low alkalinity will raise or lower the TA reading of the water.
- F. When the Total Alkalinity is within the recommended range, proceed to the next step.

BALANCING THE CALCIUM HARDNESS (CH)

- A. The recommended Calcium Hardness (CH) level for your spa is 150-200 ppm.
- B. Calcium Hardness is a measure of the total amount of dissolved calcium in the water. Calcium helps control the corrosive nature of the spa's

water. That's why calcium-low water (commonly known as "soft" water) is not recommended. It is very corrosive to the equipment, and can cause staining of the spa shell.

- C. If the CH is too high (commonly known as "hard" water), formation of scale on the spa's shell surface and equipment can result. **CH can be decreased by dilution – a mixture of 75% hard and 25% soft water will be a good starting point.** If soft water is not available, or practical for you, a stain and scale control such as Hot Spring® FreshWater® Stain and Scale Defense should be added to the spa water, according to instructions on its label.
- D. Once the CH is balanced, it normally remains stable, although the addition of more water with a high or low calcium content will raise or lower the CH reading of the water.
- E. When the Calcium Hardness is within the recommended range, proceed to the next step.

BALANCING THE pH

- A. The ideal pH level for your spa water is 7.4-7.6.
- B. The pH level is the measure of acidity and alkalinity. Values above 7 are alkaline; those below 7 are acidic. Maintaining the proper pH level is extremely important for:
 - Optimizing the effectiveness of the sanitizer.
 - Maintaining water that is comfortable for the user.
 - Preventing equipment deterioration.

- C. If the spa water's pH level is too low, the following may result:
 - The sanitizer will dissipate rapidly.
 - The water may become irritating to spa users.
 - The spa's equipment may corrode.

If the pH is too low, it can be increased by adding Hot Spring FreshWater pH/Alkalinity Up, or sodium hydrogen carbonate to the spa water.

- D. If the pH level is too high, the following may result:
 - The sanitizer is less effective.
 - Scale will form on the spa shell surface and the equipment.
 - The water may become cloudy.
 - The filter cartridge pores may become obstructed.

ALKALINE SPA WATER (SCALING ZONE)	8.2	ADD pH DECREASER TO LOWER pH
	7.8	
	7.6	
COMFORT ZONE	7.4	IDEAL
ACIDIC SPA WATER (CORROSIVE ZONE)	7.2	ADD pH INCREASER TO RAISE pH
	6.8	
	pH	

THE WATKINS WATER MAINTENANCE QUICK REFERENCE GUIDE

Steps	Ideal Range (ppm)		What Chemicals to Use	
	Minimum	Maximum	To Raise	To Lower
1 Total Alkalinity	125	150	HotSpring FreshWater® pH/Alkalinity Up (Sodium Hydrogen Carbonate, or Sodium Bicarbonate)	HotSpring FreshWater pH/Alkalinity Down (Sodium Bisulfate)
2 Calcium Hardness	150	200	HotSpring FreshWater Calcium Hardness Increaser	Use a mixture of 75% hard water and 25% soft water or use a Stain and Scale Inhibitor
3 pH	7.4	7.6	HotSpring FreshWater pH/Alkalinity Up (Sodium Hydrogen Carbonate)	HotSpring FreshWater pH/Alkalinity Down (Sodium Bisulfate)
4 Sanitizer	See section on Maintaining the Sanitizer Level			

If the pH is too high, it can be decreased by adding Hot Spring FreshWater pH/Alkalinity Down, or sodium bisulfate to the spa water.

NOTE: After adding sodium hydrogen carbonate or sodium bisulfate, wait two hours before testing the water for pH. Measurements taken too soon may not be accurate.

- E. It is important to check the pH on a regular basis. The pH will be affected by the bather load, the addition of new water, the addition of various chemicals, and the type of sanitizer used.
- F. When the pH is within the recommended range, proceed to the final step.

MAINTAINING THE SANITIZER LEVEL

- A. Sanitizer is extremely important for killing algae, bacteria and viruses, and preventing unwanted organisms from growing in the spa. At the same time, you don't want too high a sanitizer level, or it can irritate your skin, lungs, and eyes.
- B. Always maintain the sanitizer level in your spa at the recommended level for each type of sanitizer.
- C. Watkins recommends only the following sanitizers:

- Sodium Dichloro-s-Triazinetrione (sodium dichlor or chlorine)
- Brominating Concentrate™ (one step granular bromine)
- BaquaSpa® (please consult your BaquaSpa manual for instructions on the use of this product).

⚠ **WARNING:** DO NOT use tri-chlor chlorine, bromo-chloro-dimethyl-hydantoin (BCDMH), or any type of compressed bromine or chlorine, acid or any type of sanitizer which is not recommended by Watkins Manufacturing Corporation.

EVERFRESH® WATER CARE SYSTEM

The EverFresh water care system is comprised of the following products:

- FreshStart®_{10,000} Pre-filter
- Sodium dichlor
- Monopersulfate (MPS)
- FreshWater® III high output ozone system
- FreshWater_{Ag+}® silver ion purifier

FreshStart®_{10,000} Pre-filter is used when filling a spa for the first time or at refill. It attaches to a garden hose and filters out rust, dirt, detergents, algae and chemicals.

Sodium Dichlor (chlorine) is the only recommended sanitizer that will work in conjunction with all of the other products in this system.

FreshWater III high output ozone system uses Corona Discharge technology to produce a high concentration of ozone which is injected into the spa water.

Monopersulfate (MPS) is an oxidizing chemical used to prevent the buildup of contaminants, maximize sanitizer efficiency, minimize combined chlorine, and improve water clarity.

FreshWater_{Ag+} silver ion purifier introduces silver ions into the spa water, inhibiting bacteria growth. When combined with MPS, or chlorine, oxidizes particulates in the spa water.

It is important to follow the recommended application and maintenance programs outlined for each product's use.

If the spa is being used over an extended period of time, such as a whole afternoon or evening, additional sanitizer will be needed.

A weekly "shock treatment" is required.

The shock treatment quickly destroys any remaining contaminants while revitalizing the silver ion cartridge, allowing the silver ions to continue to be released into the water. Without this weekly shock treatment, the silver ion cartridge may stop releasing silver ions into the water.

To weekly "shock treat" your spa you may use either MPS or sodium dichlor. It will require much less sodium dichlor to administer the shock treatment than MPS (one teaspoon of sodium dichlor has oxidizing capabilities comparable to two tablespoons of MPS). Sodium dichlor may be a more appropriate weekly shock for those users that experience heavy bather load conditions.

IMPORTANT NOTE: MPS is an oxidizer, not a sanitizer.

FRESHWATER_{Ag+} SILVER ION PURIFIER REPLACEMENT

When replacing the silver ion purifier (every four months), it is highly recommended that the spa be drained and refilled at the same time. After refilling the spa with water, balance the Total Alkalinity (TA), Calcium Hardness (CH) and pH to the recommended levels. Shock the spa by adding sodium dichlor (See Sanitization Table for details).

1. Fold back the vinyl cover.
2. Carefully remove and set aside the filter compartment cover.
3. Remove any floating items within the filter compartment.

4. Locate the gray filter cap. Turn the filler cap counterclockwise until the cap can be removed from the filter standpipe.
5. Remove and clean filter cartridge.

NOTE: When replacing the FreshWater^{Ag+} silver ion purifier, it is an excellent time to clean and rotate the filter to extend its life. To rotate the filter, simply replace the existing filter with another one. Then clean and store the old one until the next time the FreshWater^{Ag+} silver ion purifier needs replacement.

TIGER RIVER® WATER TREATMENT GUIDE																
At spa startup or refill	Follow spa Start-Up and Refill Procedures. NOTE: Use the FreshStart ^{10,000} pre-filter when filling the spa to remove unwanted contaminants.															
Prior to each use <small>(Test before adding any chemicals; do not add any chemicals if proper, or higher levels are found.)</small>	<table style="width: 100%; border: none;"> <tr> <td style="width: 50%; vertical-align: top;"> Add one half (1/2) teaspoon of sodium dichlor per 250 gallons (950 liters) <table style="margin-left: 20px;"> <tr><td>Caspian™ (Model CHP)</td><td>2/3 teaspoon</td></tr> <tr><td>Bengal® (Model M / MM)</td><td>2/3 teaspoon</td></tr> <tr><td>Sumatran® (Model N)</td><td>2/3 teaspoon</td></tr> </table> </td> <td style="width: 10%; text-align: center; vertical-align: middle;">OR</td> <td style="width: 40%; vertical-align: top;"> Add one (1) tablespoon of monopersulfate (MPS)* per 250 gallons (950 liters) <table style="margin-left: 20px;"> <tr><td>Caspian (Model CHP)</td><td>1-1/3 tablespoons</td></tr> <tr><td>Bengal (Model M / MM)</td><td>1-1/3 tablespoons</td></tr> <tr><td>Sumatran (Model N)</td><td>1-1/4 tablespoons</td></tr> </table> </td> </tr> </table>	Add one half (1/2) teaspoon of sodium dichlor per 250 gallons (950 liters) <table style="margin-left: 20px;"> <tr><td>Caspian™ (Model CHP)</td><td>2/3 teaspoon</td></tr> <tr><td>Bengal® (Model M / MM)</td><td>2/3 teaspoon</td></tr> <tr><td>Sumatran® (Model N)</td><td>2/3 teaspoon</td></tr> </table>	Caspian™ (Model CHP)	2/3 teaspoon	Bengal® (Model M / MM)	2/3 teaspoon	Sumatran® (Model N)	2/3 teaspoon	OR	Add one (1) tablespoon of monopersulfate (MPS)* per 250 gallons (950 liters) <table style="margin-left: 20px;"> <tr><td>Caspian (Model CHP)</td><td>1-1/3 tablespoons</td></tr> <tr><td>Bengal (Model M / MM)</td><td>1-1/3 tablespoons</td></tr> <tr><td>Sumatran (Model N)</td><td>1-1/4 tablespoons</td></tr> </table>	Caspian (Model CHP)	1-1/3 tablespoons	Bengal (Model M / MM)	1-1/3 tablespoons	Sumatran (Model N)	1-1/4 tablespoons
Add one half (1/2) teaspoon of sodium dichlor per 250 gallons (950 liters) <table style="margin-left: 20px;"> <tr><td>Caspian™ (Model CHP)</td><td>2/3 teaspoon</td></tr> <tr><td>Bengal® (Model M / MM)</td><td>2/3 teaspoon</td></tr> <tr><td>Sumatran® (Model N)</td><td>2/3 teaspoon</td></tr> </table>	Caspian™ (Model CHP)	2/3 teaspoon	Bengal® (Model M / MM)	2/3 teaspoon	Sumatran® (Model N)	2/3 teaspoon	OR	Add one (1) tablespoon of monopersulfate (MPS)* per 250 gallons (950 liters) <table style="margin-left: 20px;"> <tr><td>Caspian (Model CHP)</td><td>1-1/3 tablespoons</td></tr> <tr><td>Bengal (Model M / MM)</td><td>1-1/3 tablespoons</td></tr> <tr><td>Sumatran (Model N)</td><td>1-1/4 tablespoons</td></tr> </table>	Caspian (Model CHP)	1-1/3 tablespoons	Bengal (Model M / MM)	1-1/3 tablespoons	Sumatran (Model N)	1-1/4 tablespoons		
Caspian™ (Model CHP)	2/3 teaspoon															
Bengal® (Model M / MM)	2/3 teaspoon															
Sumatran® (Model N)	2/3 teaspoon															
Caspian (Model CHP)	1-1/3 tablespoons															
Bengal (Model M / MM)	1-1/3 tablespoons															
Sumatran (Model N)	1-1/4 tablespoons															
Once a week	<table style="width: 100%; border: none;"> <tr> <td style="width: 50%; vertical-align: top;"> Add one and one half (1-1/2) teaspoons of sodium dichlor per 250 gallons (950 liters) <table style="margin-left: 20px;"> <tr><td>Caspian (Model CHP)</td><td>2 teaspoon</td></tr> <tr><td>Bengal (Model M / MM)</td><td>2 teaspoon</td></tr> <tr><td>Sumatran (Model N)</td><td>1-3/4 teaspoons</td></tr> </table> </td> <td style="width: 10%; text-align: center; vertical-align: middle;">OR</td> <td style="width: 40%; vertical-align: top;"> Add three (3) tablespoons of monopersulfate (MPS)* per 250 gallons (950 liters) <table style="margin-left: 20px;"> <tr><td>Caspian™ (Model CHP)</td><td>4 tablespoons</td></tr> <tr><td>Bengal (Model M / MM)</td><td>4 tablespoons</td></tr> <tr><td>Sumatran (Model N)</td><td>3-1/2 tablespoons</td></tr> </table> </td> </tr> </table>	Add one and one half (1-1/2) teaspoons of sodium dichlor per 250 gallons (950 liters) <table style="margin-left: 20px;"> <tr><td>Caspian (Model CHP)</td><td>2 teaspoon</td></tr> <tr><td>Bengal (Model M / MM)</td><td>2 teaspoon</td></tr> <tr><td>Sumatran (Model N)</td><td>1-3/4 teaspoons</td></tr> </table>	Caspian (Model CHP)	2 teaspoon	Bengal (Model M / MM)	2 teaspoon	Sumatran (Model N)	1-3/4 teaspoons	OR	Add three (3) tablespoons of monopersulfate (MPS)* per 250 gallons (950 liters) <table style="margin-left: 20px;"> <tr><td>Caspian™ (Model CHP)</td><td>4 tablespoons</td></tr> <tr><td>Bengal (Model M / MM)</td><td>4 tablespoons</td></tr> <tr><td>Sumatran (Model N)</td><td>3-1/2 tablespoons</td></tr> </table>	Caspian™ (Model CHP)	4 tablespoons	Bengal (Model M / MM)	4 tablespoons	Sumatran (Model N)	3-1/2 tablespoons
Add one and one half (1-1/2) teaspoons of sodium dichlor per 250 gallons (950 liters) <table style="margin-left: 20px;"> <tr><td>Caspian (Model CHP)</td><td>2 teaspoon</td></tr> <tr><td>Bengal (Model M / MM)</td><td>2 teaspoon</td></tr> <tr><td>Sumatran (Model N)</td><td>1-3/4 teaspoons</td></tr> </table>	Caspian (Model CHP)	2 teaspoon	Bengal (Model M / MM)	2 teaspoon	Sumatran (Model N)	1-3/4 teaspoons	OR	Add three (3) tablespoons of monopersulfate (MPS)* per 250 gallons (950 liters) <table style="margin-left: 20px;"> <tr><td>Caspian™ (Model CHP)</td><td>4 tablespoons</td></tr> <tr><td>Bengal (Model M / MM)</td><td>4 tablespoons</td></tr> <tr><td>Sumatran (Model N)</td><td>3-1/2 tablespoons</td></tr> </table>	Caspian™ (Model CHP)	4 tablespoons	Bengal (Model M / MM)	4 tablespoons	Sumatran (Model N)	3-1/2 tablespoons		
Caspian (Model CHP)	2 teaspoon															
Bengal (Model M / MM)	2 teaspoon															
Sumatran (Model N)	1-3/4 teaspoons															
Caspian™ (Model CHP)	4 tablespoons															
Bengal (Model M / MM)	4 tablespoons															
Sumatran (Model N)	3-1/2 tablespoons															
Every four months	Drain and refill your spa. Replace the FreshWater ^{Ag+} silver ion purifier NOTE: Use the FreshStart ^{10,000} pre-filter when filling the spa to remove unwanted contaminants.															
As needed, if water is hazy, cloudy, or has an odor	Add one and one half (1-1/2) teaspoons of sodium dichlor per 250 gallons (950 liters) <table style="margin-left: 20px;"> <tr><td>Caspian (Model CHP)</td><td>2 teaspoons</td></tr> <tr><td>Bengal (Model M / MM)</td><td>2 teaspoons</td></tr> <tr><td>Sumatran (Model N)</td><td>1-3/4 teaspoons</td></tr> </table>	Caspian (Model CHP)	2 teaspoons	Bengal (Model M / MM)	2 teaspoons	Sumatran (Model N)	1-3/4 teaspoons									
Caspian (Model CHP)	2 teaspoons															
Bengal (Model M / MM)	2 teaspoons															
Sumatran (Model N)	1-3/4 teaspoons															

*MPS is an oxidizer, not a sanitizer.

6. Remove the existing FreshWater^{Ag+} silver ion purifier.
7. Install the new FreshWater^{Ag+} silver ion purifier into the filter standpipe. Do not force the FreshWater^{Ag+} silver ion purifier down into the filter standpipe.
8. Reinstall the cleaned filter cartridge.
9. Replace and secure the gray filter cap.
10. Replace the filter compartment cover.
11. Fold the cover back into place.

⚠ **WARNING:** Never use the spa with the filter cartridge or filter standpipe removed!

SILVER IONS QUESTIONS AND ANSWERS

Question: How are the silver ions actually added to the water?

Answer: The silver ion cartridge contains ceramic beads that are infused with silver. By placing the cartridge in the circulation pump filter standpipe, it is subjected to the continuous flow of water created by the pump's 24 hour circulation. The flowing water, through a chemical erosion process, carries with it the silver ions necessary to add a sanitizing residual to the spa water.

Question: What happens if I do not add the weekly shock treatment?

Answer: The contaminants in the water may coat the silver ion cartridge's ceramic beads, blocking the silver ions' release into the water. When this occurs, there will be no residual of silver ions present in the water, eliminating them from the sanitizing process.

Question: How often should the FreshWater®_{Ag+} silver ion purifier cartridge be replaced?

Answer: The cartridge must be replaced every four months. Please refer to the instructions provided with each FreshWater_{Ag+} silver ion purifier cartridge.

Question: Can I use the FreshWater III ozone system in addition to the silver ion system?

Answer: Yes. In fact, it is preferred! The use of the FreshWater III ozone system will enhance the performance of the silver ions and may substantially reduce the need for supplemental chemical treatments when the spa is not in use.

Question: Why can't I use bromine or biguanides instead of MPS or chlorine?

Answer: Bromine and biguanides will chemically react with the sanitizing action of the silver ions. This will eliminate their beneficial sanitizing effect.

DOS AND DON'TS

- DO check your MPS or sodium dichlor chemical level prior to each use.
- DO check your sanitizer prior to each use.
- DO change the FreshWater_{Ag+} silver ion purifier every four months.
- DO test Total Alkalinity and pH weekly.
- DO use MPS for spas only, such as Hot Spring® MPS chlorine-free oxidizer.
- DO store all chemicals in a tightly sealed container in a cool, dry place.
- DON'T use bromine or biguanides. These are active sanitizers and will combine with the silver ions to inactivate them.
- DON'T use a water clarifier. Clarifiers will cause the spa water to become cloudy.

CHLORINE (SODIUM DICHLOR)

- A. Sanitizing chemicals, such as chlorine, are oxidants that kill bacteria and viruses in the water. The Free Available Chlorine (FAC) is a measure of the amount of unused chlorine available to sanitize the spa. The recommended FAC for your spa water is 3.0-5.0 ppm.
- B. Watkins Manufacturing Corporation recommends the use of sodium dichlor type granulated chlorine for sanitizing the water. Sodium dichlor is preferred because it is totally soluble, dissolves quickly and is nearly pH neutral.
- C. Maintaining the proper level of chlorine during use is extremely important.
- D. If the FAC is too low, bacteria and viruses can grow rapidly in the warm water. **Increase the FAC by adding granulated sodium dichlor.**
- E. If the FAC is too high, the water can cause discomfort to the user's eyes, lungs and skin. **Simply allow some time to pass. The FAC level will naturally drop over time.**
- F. When the Free Available Chlorine is within the recommended range, the spa is ready to be enjoyed.

⚠ **WARNING:** There are several forms of stabilized chlorine available for use in spas and swimming pools and each form has specific chemical characteristics. It is extremely important that the one you choose is specifically designed for use in spas. Use of an incorrect product such as tri-chlor, which has a very low pH (2.6), dissolves too quickly in hot water resulting in extremely high levels of chlorine, and is designed for concrete or plaster swimming pools, **WILL** cause damage to your spa. Use of a liquid or any type of compressed bromine or chlorine, acid or any type of sanitizer which is not recommended by Watkins Manufacturing Corporation **WILL** damage your spa and is specifically not covered under the terms of the limited warranty.

IMPORTANT: Granulated chlorine (sodium dichlor) will degrade if stored improperly. We recommend purchasing chlorine in one or two pound containers and storing it in a cool, dry place to maintain its potency.

CHLORINE DPD TEST KIT OR TEST STRIP READING	DO NOT USE THE SPA UNTIL THE TEST KIT READING IS BELOW THIS LEVEL
5.0	RECOMMENDED LEVEL SAFE
4.0	
3.0	
ADD CHLORINE	
2.0	DO NOT USE SPA ; ADD CHLORINE TO REACH RECOMMENDED SAFE LEVEL
1.0	
0	

SUPER CHLORINATION

Super chlorination is designed to "burn-off" the build-up of chloramines (used chlorine), to eliminate the chlorine smell and to allow the proper level of free chlorine to be maintained.

When giving your water a super chlorination treatment, open the cover at least half way for twenty minutes to allow the chlorine gas to vent off. The high concentration of chlorine gas which may exist as a result of super chlorination (not daily sanitation) may eventually cause discoloration or degradation to the bottom of the cover or the tile grouting, which would not be covered under the terms of your limited warranty.

⚠ **WARNING:** Always allow the Free Available Chlorine to fall to 5 ppm before using the spa.

⚠ **WARNING:** Never leave an open spa unattended, especially if there are children present!

BUILDING A SANITIZER ROUTINE

During the first month of ownership, measure the sanitizer residual daily in order to establish standards for User Load and Usage Time versus

Sanitizer Needed.

- The User Load of the spa is the number of times anyone enters the spa.
- The Usage Time is simply the amount of time a user spends in the spa.
- Sanitizer Needed is the amount of Free Chlorine Residual needed to accommodate the number of users and their combined usage time.

For example, two spa users who regularly use the spa once an evening for twenty minutes create a specific and somewhat consistent demand on the sanitizer. During the first month of ownership, these two users can determine exactly how much sanitizer to use in order to maintain the proper residual. If, at any time, the user load and/or usage pattern changes dramatically (invited guests), the amount and frequency of sanitizer required increases dramatically.

The greater the usage time or the user load, the faster the residual value is diminished.

SUPPLEMENTAL WATER MAINTENANCE

Proper water sanitation and mineral balance (pH control) are absolutely essential for a complete spa water maintenance program. Here are three other popular water additives that are optional:

Mineral Deposit Inhibitors

As water evaporates from your spa and new water is added, the amount of dissolved minerals will increase. (Minimize evaporation by keeping the cover on the spa whenever possible.) The spa water may eventually become “hard” (Calcium Hardness too high) enough to damage the heater by calcifying its surface. Proper pH control can minimize this.

Normal soap build-up will require water replacement regularly enough that mineral deposits normally are not a problem.

Occasionally, high iron or copper content in the water may produce green or brown stains on the spa. A mineral deposit inhibitor may help to reduce these metals.

NOTE: Well water may contain high concentrations of minerals. The use of a low water volume, extra-fine pore water filter (in-line pre-filter such as the FreshStart[®] 10,000 pre-filter) will help to remove many of the larger particles during the filling of the spa. In-line pre-filters can be purchased at your local Tiger River[®] dealer.

Foam Inhibitors

Spa water requires changing due to the buildup of soap in the water. Typically, soap will cause the spa water to foam when the jets are used. Soap is introduced into the spa water from two sources: users’ bodies, which retain a soap residual after showering, and swimming apparel, which retains soap after washing.

Foam inhibitors can suppress foam, but cannot remove soap from the water. Soap is very difficult to remove from the water because soap is not oxidized by any chemical added to the spa. Only ozone can oxidize soap.

Eventually the soap build-up in the water will be concentrated, resulting in an unclean feeling on the bather’s skin which is impossible to remedy. When this occurs, it’s time to drain and refill the spa. Depending on the soap input, the water should last about four months before needing to be drained.

OZONE

Ozone is a powerful oxidizing agent which is produced in nature, and artificially by man. Ozone will oxidize a wide range of water contaminants, from soap residue to bacteria.

The FreshWater[®] III high-output ozone system is the only ozone purification system approved for installation in your Tiger River[®] spa. The FreshWater III ozone system features Corona Discharge (CD) technology to produce a higher concentration of ozone than is produced by competing ultraviolet light (UV) ozone systems.

The under-the-cabinet mounted FreshWater III high-output ozone system offers less-visible installation and is less susceptible to the effects of freezing temperatures. To access it for inspection, remove the equipment compartment door to check the unit operation (this is usually done prior to disconnecting the power to the spa before draining). Simply listen for the buzz of the transformer to verify operation of the FreshWater III high output ozone system.



The FreshWater III high-output ozone system greatly enhances the quality of the spa water when used to supplement the spa owner’s regular water maintenance program. Contrary to some information circulated throughout the pool and spa industry regarding ozone systems, ozone **CAN NOT** be used as a single-source sanitizer, water clarifier, anti-foamer, and mineral chelating agent. A secondary source sanitizer must be used to maintain 2.0 ppm (2.0 mg/L) of Free Available Chlorine (FAC). Watkins Manufacturing Corporation recommends that a chemical maintenance program based on recognized and documented industry standards still be followed when using an ozone purification system to assure water sanitation and the highest quality purified water.

Cleaning the Ozone Injector

On occasion, a mineral build-up may clog the ozone injector, causing a lack of flow, or low flow of ozone bubbles. To prevent this, refer to the following instructions to clean the injector:

1. Disconnect power to the spa.

2. Access the equipment compartment.
3. Locate the ozonator in the equipment compartment and unplug the ozonator from the control box.

 <p>WARNING</p>	<p>Nitric acid accumulates in the air lines of the ozonator and injector. Nitric acid will cause severe chemical burns if direct skin contact is made, so always wear protective gloves, glasses and clothing when working on the ozonator or injector lines. To prevent inhalation or ingestion of the nitric acid, DO NOT blow or inhale with your mouth to any of the adapters, fittings or tubing of the ozonator or injector air lines.</p>	 <p>WARNING</p>
---	---	---

4. Place 16 ounces of white vinegar into a container such as a cup or bucket. Place the container on the equipment compartment floor. NOTE: White vinegar will not damage any of the spa components.
5. Carefully loosen the long Tygon/Kynar tubing to the bottom of the ozonator. **A liquid substance may be found inside the tubing. If a liquid substance is present, BE CERTAIN NOT TO COME INTO CONTACT WITH THE LIQUID (SEE WARNING ON PREVIOUS PAGE).**
6. Place the end of the tubing into the vinegar, making certain that the end of the tubing sits at the bottom of the container.
7. Reconnect power to the spa.
8. Run the spa until all 16 ounces of the vinegar are gone. This should allow an ample flow of vinegar to be run through the injector and clear the blockage.
9. Disconnect power to the spa.
10. Remove the empty cup or bucket.
11. Reinstall the tubing to the bottom of the ozonator.
12. Plug the ozonator into the control box.
13. Close the equipment compartment door.
14. Reconnect power to the spa.

DOS AND DON'TS

- DON'T use swimming pool (muriatic) acid to lower pH.
- DON'T splash pH increaser additives on the SureWood® cabinet.
- DON'T use Compressed Sanitizers.

The use of bromine sticks or tablets in floaters, which may become entrapped in a lounge or cooling seat (or sink to the spa floor), have been shown to cause discoloration of or surface distress to a spa's shell.

- DON'T use a floater type sanitization system as a low or no maintenance solution to your spa maintenance program.

The spa shell easily can withstand the effects of a properly administered sanitizer. Floating dispensers can become trapped in one area and cause an over-sanitization (or chemical burn) of that particular area.

If the dispenser setting is too high, the high concentration can discolor the spa shell and damage the underside of the cover.

Automatic floating dispensers have a tendency to either over-brominate or under-brominate as the rate of erosion varies greatly. Damage to the spa and cover can occur very quickly.

⚠ WARNING: Watkins Manufacturing Corporation **DOES NOT** recommend the use of any floating chemical dispenser. Damage to the spa shell or components caused by a floating chemical dispenser is specifically not covered under the terms of the limited warranty.

- DON'T use a sanitizer which is not designed for spas.
- DON'T use household bleach (liquid sodium hypochlorite).
- DON'T broadcast or sprinkle the chemicals onto the water surface. This method may cause chemically-induced spa surface blistering (chemical abuse).
- DO use only a granular form of sanitizer.
- DO add all chemicals slowly into the filter compartment with the jet pump operating for ten minutes.
- DO use special care if using baking soda to clean either the interior or exterior plastic surfaces.

COMMON WATER CHEMISTRY QUESTIONS

Question: Why can't I use a floater to sanitize my spa water?

Answer: Watkins Manufacturing Corporation does not recommend the use of a floater for three reasons.

1. The floater is unable to control the rate at which sanitizer is dissolved into the water. When a floater is first placed in a spa, the sanitizer level can be extremely high. High sanitizer levels can chemically burn or discolor the spa's shell or the underside of the cover. Then, after a period of time, the sanitizer level dispensed by the floater will fall to near zero. A low sanitizer level will allow viruses, bacteria or algae to grow.
2. Floaters tend to stay in one area of the spa most of the time (usually over the cool down seat), causing this area to be exposed to extreme sanitizer levels.
3. The floater may allow pieces of the highly concentrated sanitizer to fall out and settle on the floor or seat of the spa shell. These pieces of sanitizer will chemically burn (blister) the spa shell. Although your spa shell is specifically designed to resist the effects of spa chemicals, no spa surface can withstand this type of highly concentrated chemical. Remember, chemical abuse is specifically not covered under the terms of the warranty.

Question: When I open my spa, I smell chlorine. How do I get rid of this smell?

Answer: There are two types of chlorine in your spa. The first is the Free Available Chlorine, which is the chlorine available to sanitize your spa. This available free chlorine does not have an odor. The second is Chloramine, which is residue from chlorine already expended. Chloramines have a strong chlorine odor. The smell from Chloramines can be eliminated by "shocking" the water. If you smell chlorine in the water, your spa is reminding you to add a shock treatment.

Question: Why can't I fill my spa with soft water?

Answer: Soft water is essentially the same as regular water except that most or all of the calcium has been replaced by sodium. Soft water may be corrosive to the heater and other components. Replacement of spa components damaged by soft water is extremely expensive.

Question: I am trying to reduce the number of chemicals to which my family is exposed. Do I really need to use so many chemicals and in such large amounts?

Answer: While over-exposure to any chemical can be unhealthful, many low levels of chemicals are effective and beneficial. In the case of spa water, the chemicals recommended in the Tiger River[®] Water Maintenance Program are needed to protect the user from water-borne pathogens (disease-causing microbes) and to prevent corrosion of spa components. The EverFresh[®] water care system minimizes the use of chemicals with harsh side effects, such as halogen sanitizers.

Question: Why isn't water chemistry damage covered by the warranty?

Answer: The chemical levels and water quality of the water in the spa are under your direct control. With proper basic care, the spa will provide many years of hot water relaxation. If you are unsure about any chemical or its usage in the spa, contact your Authorized Dealer, or Watkins Manufacturing Corporation.

WATER TERMINOLOGY

The following chemical terms are used in this Water Quality and Maintenance section. Understanding their meaning will help you to better understand the water maintenance process.

Bromamines: Compounds formed when bromine combines with nitrogen from body oils, urine, perspiration, etc. Unlike chloramines, bromamines have no pungent odor, and are effective sanitizers.

Bromine: A halogen sanitizer (in the same chemical family as chlorine). Bromine is commonly used in stick, tablet, or granular form. See the DO's and DON'Ts of Spa Water Maintenance for additional information.

Calcium Hardness: The amount of dissolved calcium in the spa water. This should be approximately 150-200 ppm. High levels of calcium can cause cloudy water and scaling. Low levels can cause harm to the spa equipment.

Chloramines: Compounds formed when chlorine combines with nitrogen from body oils, urine, perspiration, etc. Chloramines can cause eye irritation as well as having a strong odor. Unlike bromamines, chloramines are weaker, slower sanitizers.

Chlorine: An efficient sanitizing chemical for spas. Watkins Manufacturing Corporation recommends the use of sodium dichlor-type granulated chlorine. This type is preferred because it is totally soluble and nearly pH neutral.

Chlorine (or Bromine) Residual: The amount of chlorine or bromine remaining after chlorine or bromine demand has been satisfied. The residual is, therefore, the amount of sanitizer which is chemically available to kill bacteria, viruses and algae.

Corrosion: The gradual wearing away of metal spa parts, usually caused by chemical action. Generally, corrosion is caused by low pH or by water with levels of TA, CH, pH or sanitizer which are outside the recommended ranges.

DPD: The preferred reagent used in test kits to measure the Free Available Chlorine.

Halogen: Any one of these five elements: fluorine, chlorine, bromine, iodine, and astatine.

MPS: Monopersulfate is the non-chlorine oxidizer used with the FreshWater_{Ag}[®] silver ion purification system.

Nitric Acid: The formulation of nitric acid, a highly corrosive chemical, is a byproduct of the ozone generating process. Nitric acid is produced in very small quantities and is readily dissolved in the water stream with ozone.

Oxidizer: The use of an oxidizing chemical is to prevent the buildup of contaminants, maximize sanitizer efficiency, minimize combined chlorine and improve water clarity.

Ozone: Ozone is a powerful oxidizing agent which is produced in nature and artificially by man. Ozone forms no byproducts of chloramines (ozone actually oxidizes chloramines) and will not alter the water's pH.

Pathogen: A microorganism such as bacterium that cause disease.

pH: The measure of the spa water's acidity and alkalinity. The recommended pH for the spa water is 7.4 to 7.6. Below 7.0 (considered neutral), the spa water is too acidic and can damage the heating system. Above 7.8, the water is too alkaline and can result in cloudy water, and scale formation on the shell and heater.

ppm: The abbreviation of "parts per million", the standard measurement of chemical concentration in water. Identical to mg/l (milligrams per liter).

Reagent: A chemical material in liquid, powder, or tablet form for use in chemical testing.

Sanitizer: Sanitizers are added and maintained at recommended residuals to protect bathers against pathogenic organisms which can cause disease and infection in spa water.

Scale: Rough calcium-bearing deposits that can coat spa surfaces, heaters, plumbing lines, and clog filters. Generally, scaling is caused by mineral content combined with high pH. Additionally, scale forms more readily at higher water temperatures.

Super-Chlorination: Also known as "shock treatment." Super-Chlorination is a process of adding significant doses of a quick dissolving sanitizer ("dichlor" is recommended) to oxidize non-filterable organic waste and to remove chloramines and bromamines.

Total Alkalinity: The amount of bicarbonates, carbonates, and hydroxides present in spa water. Proper total alkalinity is important for pH control. If the TA is too high, the pH is difficult to adjust. If the TA is too low, the pH will be difficult to hold at the proper level. The desired range of TA in spa water is 125 to 150 ppm.

SERVICE INFORMATION

Your Tiger River® spa has been designed to provide years of trouble-free use. As with any appliance, problems may occasionally occur that require the expertise of a qualified service person. Though such simple repairs as resetting a GFCI switch or breaker, resetting a high limit thermostat or replacing a light bulb may not require a service call, they may indicate that a more serious condition exists. These conditions may require an experienced service person. Before calling for service, please refer to the Troubleshooting Guide.

NOTE: Always retain your original sales receipt for future reference.

GFCI AND HIGH LIMIT THERMOSTAT

If your spa fails to operate at any time, first check the power supply to the spa.

In 115 volt models, check the GFCI at the end of the power cord. In 230 volt models, check each of the GFCI breakers in the subpanel. If a GFCI has tripped, reset it. If it will not reset, this may be an indication of a ground fault (short circuit) within the electrical components. Contact an Authorized Service Technician for a complete diagnosis.

If upon checking the GFCI's you find that they have not tripped, check the house breaker panel and ensure that the main breaker for the electrical circuit supplying the spa has not tripped. If it has, this is an indication that the circuit was either overloaded or a ground fault exists between the breaker panel and the spa receptacle or subpanel. Contact a qualified electrician.

If upon checking the main house breaker and spa GFCI's you find no failures, check the high limit thermostat. To check it, simply turn off power to the spa for 30 seconds. This will automatically reset the high limit thermostat if it has tripped. If the spa energizes once you turn the power back on, this indicates reduced water flow through the heating system. Tripping of the high limit thermostat is normally a result of one or a combination of these problems: 1) clogged filter cartridges, 2) blockage within the system plumbing, 3) a non-functioning heater circulation pump, 4) power was not disconnected from the spa before it was drained, 5) an air lock in the plumbing lines. (The Power Indicator on the front of the spa's control panel will also be blinking if the high limit thermostat circuit has tripped.)

If the spa does not function after tripping and resetting the GFCI's or resetting the high limit thermostat, then the problem should be referred to a qualified service technician. Refer to the Heater section if the spa operates but does not heat, or refer to the Troubleshooting Guide for additional service information.

NO-FAULT® HEATER AND INTEGRATED PRESSURE SWITCH

Watkins Manufacturing Corporation unconditionally warrants the No-Fault heater against any failure that would require replacement. This warranty's duration is equal to the time period identified in the Component Warranty. This warranty defines unconditional as warranty coverage without exception provided that the component has failed to operate properly within the spa's system. This means that conditions that would normally invalidate the limited warranty, such as water chemistry damage, do not apply to the No-Fault heater.

It is important to note that the No-Fault heater is protected by both the heater high limit thermostat circuit and the integrated pressure switch. The causes of heater high limit tripping are discussed in the previous section.

If the spa is not heating, the red and green lights are blinking, but the pump and light are operating, then the pressure switch may be open. Opening of the pressure switch is normally a result of one or a combination of these problems: 1) a clogged filter cartridge, 2) blockage within the

system plumbing, 3) power was not disconnected to the spa before it was drained, or 4) an air lock in the plumbing lines. Once the problem has been identified and corrected the pressure switch will close which will energize the heater.

SILENT FLO 5000® CIRCULATION PUMP AND CIRCULATION PUMP THERMAL CUT-OFF

The Hot Spring® Silent Flo 5000 circulation pump is a dedicated, water cooled, energy efficient, quiet pump that provides continuous filtration for the spa. Since the Silent Flo 5000 circulation pump is water cooled, it is equipped with a thermal cut-off to prevent the pump from being damaged by running hot when water is not present.

Reset the circulation pump's thermal cut-off by disconnecting power to the spa and allowing the pump to cool.

Tripping of the thermal cut-off is normally the result of one or a combination of these problems: 1) clogged filter cartridge(s), 2) blockage within the system plumbing, 3) power was not disconnected to the spa before it was drained, or 4) an air lock in the plumbing lines. Once the problem has been identified and corrected the pump thermal cut-off will be able to be reset which will allow it to operate normally.

FRESHWATER® III HIGH OUTPUT OZONE SYSTEM

The FreshWater III ozone system is practically maintenance-free because it is located within the spa's equipment compartment. If bubbles are appearing at the spa's heater return but the smell of ozone is not noticeable (the water may also appear not as clear as usual) then the operation of the ozone generator should be checked. Carefully open the equipment compartment door (remember to use care, as power is still connected to the spa) and verify that the CD tube and its transformer are energized (a slight buzz will be emitted from the ozone generator housing). If a slight buzz or hum is not audible, verify that the generator is completely plugged into the spa's control box.

If the unit is plugged in and power is connected to the spa, then the fuse (for the ozone generator) should be checked.

⚠ **WARNING:** Contact your Tiger River® dealer if your spa requires troubleshooting beyond the scope of this manual. Freshwater III ozone systems should only be serviced by a qualified technician.

WARRANTY NOTE: Cleaning of the ozone injector is not covered under the warranty. Refer to the Ozone section of this manual for instructions on cleaning the ozone injector.

MISCELLANEOUS SERVICE INFORMATION

The control and high-limit thermostats are equipped with electronic sensors that are connected to the spa's plumbing. Never cut or kink the wires that connect the sensors to the thermostats within the control box.

The jet pump is equipped with a thermal overload cutoff switch that is designed to protect the pump from overheating. If the pump shuts itself off in a new spa, it is usually the result of one or a combination of the following factors:

- Thermal overload: Although mass-produced, not all thermal overload cutoffs are exactly the same. Some are more sensitive than others and will shut the pump off at lower temperatures.
- High temperature: All Tiger River spa models are equipped with a jet pump shroud that vents the heat generated by the pump motor to the outside of the equipment compartment, and back into the spa water. If the vent is blocked by masonry, grass or debris, overheating of the jet pump may occur. Once the pump motor has cooled sufficiently and any blockage has been removed from the vent opening, the jet pump can be restarted.
- Friction: Sometimes the moving parts of a new pump are tight enough to cause heat build-up due to friction. After a normal break-in period, the pump will run cooler.
- Improper wiring: If the spa is connected with an extension cord, and/or the house wiring is undersized, the pump may starve for voltage and therefore may draw more amperage and generate excessive heat.
- If the pump is shutting down due to excessive heat, make sure the equipment compartment has adequate ventilation. The air gap at the bottom must not be blocked. Should your jet pump continue to shut off after short periods of use, contact a qualified service technician.

ACTS INVALIDATING WARRANTY

The limited warranty is void if the Tiger River spa has been subjected to alteration, misuse, or abuse, or if any repairs on the spa are attempted by anyone other than an authorized representative of Watkins Manufacturing Corporation. Alteration is defined as any component or plumbing change, electrical conversion, or the addition of any non-approved sanitation or water purification device, or heating system which contributes to a component failure, unit failure or unsafe operating condition. Misuse and abuse shall include any operation of the spa other than in accordance with Watkins Manufacturing Corporation printed instructions, or use of the spa in an application for which it is not designed; specifically: use of the spa in a non-residential application; damage caused by operation* of the spa at water temperatures outside the range of 35°F and 120 °F; damage caused by a dirty, clogged or calcified filter cartridge; damage to the spa surface caused by the use of tri-chloro chlorine, BCDMH, chemical tablets in a floater, acid, or any other spa chemicals or spa surface cleaners which are not recommended by Watkins Manufacturing Corporation; damage caused by allowing undissolved spa sanitizing chemicals to lie on the spa surface (no spa surface material can withstand this kind of abuse); damage to components or spa surface caused by improper water chemistry maintenance; and damage to the spa surface caused by leaving the spa uncovered while empty of water and in direct exposure to sunlight (this may cause solar heating distress in warm weather regions). These are considered abuses and may invalidate this warranty.

Acts of nature, and damage caused by animals, rodents, and insects are considered abuses and are not covered under this warranty.

*Operation of the spa does not mean “use” of the spa! Watkins Manufacturing Corporation does not recommend using the spa if the water temperature is above or below the spa’s control panel temperature range.

DISCLAIMERS

Watkins Manufacturing Corporation shall not be liable for loss of use of the Tiger River® spa or other incidental or consequential costs, expenses or damages, which may include but are not limited to, the removal of a permanent deck or other custom fixture. Any implied warranty shall have a duration equal to the duration of the applicable warranty stated above. Under no circumstances shall Watkins Manufacturing Corporation or any of its representatives be held liable for injury to any person or damage to any property, however arising.

WATKINS CUSTOMER SERVICE

If you have any questions about any aspect of your Tiger River spa set-up, operation or maintenance that have not been answered by this manual, consult your Tiger River dealer.

Watkins Manufacturing Corporation can be reached at: 800-999-4688 (Extension 8432), Monday through Friday, 8 a.m. to 5 p.m. Pacific Standard Time (PST), or e-mail custsvc@watkinsmfg.com.

TROUBLESHOOTING

Should you experience any problem whatsoever, do not hesitate to contact your authorized Tiger River® dealer. Here are some tips to help you to diagnose and rectify some more common sources of trouble yourself, if you choose to do so.

GENERAL OPERATION TROUBLESHOOTING GUIDE		
Problem	Probable causes	Solutions
Entire spa is inoperative	<ul style="list-style-type: none"> Power failure GFCI tripped Heater high-limit thermostat tripped 	<ul style="list-style-type: none"> Check power source Reset GFCI; call for service if it will not reset Disconnect power for at least thirty seconds to reset heater high limit. If it will not reset, check for clogged filter(s). If tripping continues, call for service. Deactivate spa lock
Spa does not heat; jets and light operate (Ready and Power indicators are blinking)	<ul style="list-style-type: none"> Spa lock activated Integrated pressure switch open Circulation pump thermal cut-off tripped 	<ul style="list-style-type: none"> Check for clogged filters. Integrated pressure switch will reset when the flow of water through the heater has been restored. Call for service if the heater trips frequently. Check for clogged filter(s) or air locks in plumbing. Disconnect power to the spa, allow circulation pump to cool. Circulation pump thermal cut-off will reset when pump has cooled and power is reapplied. Call for service if circulation pump thermal cut-off trips frequently.
Jets weak or surging	<ul style="list-style-type: none"> Spa water level too low Filter(s) clogged Comfort Control® levers closed 	<ul style="list-style-type: none"> Add water Clean filter Open Comfort Control levers
Light inoperative	<ul style="list-style-type: none"> Spa lock activated Light wiring or assembly is faulty 	<ul style="list-style-type: none"> Deactivate spa lock Replace light assembly
Power indicator blinking (Entire spa inoperative)	<ul style="list-style-type: none"> Heater high-limit thermostat tripped 	<ul style="list-style-type: none"> Disconnect power for at least thirty seconds to reset heater high limit. If it will not reset, check for clogged filter(s). If tripping continues, call for service.
Ready indicator blinking	<ul style="list-style-type: none"> Temperature sensor problem 	<ul style="list-style-type: none"> Disconnect power for at least thirty seconds. If blinking continues, call for service.

SPA WATER MAINTENANCE TROUBLESHOOTING GUIDE		
Problem	Probable causes	Solutions
Cloudy Water	<ul style="list-style-type: none"> Dirty filter(s) Excessive oils / organic matter Improper sanitization Suspended particles / organic matter Overused or old water 	<ul style="list-style-type: none"> Clean filter(s) Shock spa with sanitizer Add sanitizer Adjust pH and/or alkalinity to recommended range Run jet pump(s) and clean filter(s) Drain and refill the spa
Water Odor	<ul style="list-style-type: none"> Excessive organics in water Improper sanitization Low pH 	<ul style="list-style-type: none"> Shock spa with sanitizer Add sanitizer Adjust pH to recommended range
Chlorine Odor	<ul style="list-style-type: none"> Chloramine level too high Low pH 	<ul style="list-style-type: none"> Shock spa with sanitizer Adjust pH to recommended range
Musty Odor	<ul style="list-style-type: none"> Bacteria or algae growth 	<ul style="list-style-type: none"> Shock spa with sanitizer – if problem is visible or persistent, drain, clean, and refill the spa
Organic buildup / scum ring around spa	<ul style="list-style-type: none"> Build-up of oils and dirt 	<ul style="list-style-type: none"> Wipe off scum with clean rag – if severe, drain the spa, use a spa surface and tile cleaner to remove the scum, and refill the spa
Algae Growth	<ul style="list-style-type: none"> High pH Low sanitizer level 	<ul style="list-style-type: none"> Shock spa with sanitizer and adjust pH Shock spa with sanitizer and maintain sanitizer level
Eye Irritation	<ul style="list-style-type: none"> Low pH Low sanitizer level 	<ul style="list-style-type: none"> Adjust pH Shock spa with sanitizer and maintain sanitizer level
Skin Irritation / Rash	<ul style="list-style-type: none"> Unsanitary water Free chlorine level above 5 ppm 	<ul style="list-style-type: none"> Shock spa with sanitizer and maintain sanitizer level Allow free chlorine level to drop below 5 ppm before spa use
Stains	<ul style="list-style-type: none"> Total alkalinity and/or pH too low High iron or copper in source water 	<ul style="list-style-type: none"> Adjust total alkalinity and/or pH Use a metal deposit inhibitor
Scale	<ul style="list-style-type: none"> High calcium content in water – total alkalinity and pH too high 	<ul style="list-style-type: none"> Adjust total alkalinity and pH – if scale requires removal, drain the spa, scrub off the scale, refill the spa and balance the water

NOTES:



This manual contains installation, operating, maintenance and service information for the following 2008 Tiger River® spa models:

USA MODELS	EFFECTIVE DATE	CANADIAN MODELS	EFFECTIVE DATE
CASPIAN™ (MODEL CHP)	11/07	CASPIAN (MODEL CHPC)	11/07
BENGAL® (MODEL M / MM)	11/07	BENGAL (MODEL MC / MMC)	11/07
SUMATRAN® (MODEL N)	11/07	SUMATRAN (MODEL NC)	11/07



©2007 Watkins Manufacturing Corporation. Tiger River, Bengal, Caspian, Sumatran, No-Fault, IQ 2020, SmartJet, Comfort Control, Wavemaster, SureWood, Silent Flo 5000, JetStream, Precision, CoverCradle, Cover Shield, UpRite, GlideRite, Lift 'n Glide, EverFresh, FreshStart, FreshWater, FreshWater_{Ag+} and The Home Relaxation Specialists are trademarks of Watkins Manufacturing Corporation. BaquaSpa is a trademark of AVECIA, Inc. Windex® is a trademark of S.C. Johnson & Son, Inc. Soft Scrub® is a trademark of The Clorox Company. Brominating Concentrate™ is a trademark of Bio-Lab Inc.



Watkins Manufacturing Corporation
Vista, California
USA

PART #301498, REV. A (11/07)