



WELCOME TO THE SPA LIFE!

We sincerely hope your spa life is a pleasant experience. If problems should arise, contact your authorized Marquis Spas® dealer. Or contact Marquis Corp. at any of the following:

Email: service@marquiscorp.com
Web: www.marquisspas.com
Marquis Corp.
596 Hoffman Road
Independence, OR 97351, USA

This manual is provided to enhance your enjoyment of your spa and to prevent non-warranty situations. It is your sole responsibility to read, understand and comply with the instructions in the owner's manual. Please save your original sales receipt for reference in case of a future warranty claim. Failure to use, maintain or install the spa in compliance with this owner's manual could result in loss of warranty coverage.

SERIAL NUMBER LOCATION

You will find the serial number on the tag in the equipment area.

PLEASE FILL OUT AND KEEP FOR FUTURE REFERENCE

Name of Purchaser _____

Date of Purchase _____

Address _____

City _____ State _____ Zip Code _____

Telephone _____

Spa Model/Color _____

Spa Serial # _____

Pack Serial # _____

Dealer's Name _____

Dealer's Address _____

City _____ State _____ Zip Code _____

Telephone _____

Every effort has been made to ensure the accuracy of this manual. However, Marquis Spas® reserves the right to improve its product without notice. This could create a minor variation between this manual and the actual product you receive. We apologize for any inconvenience this may cause.

■ IMPORTANT SAFETY INSTRUCTIONS	
120V, Cord Connected Models	3
240V, Permanently Installed or Converted Models	4
All Spa Models	4-5
Personal Safety	6-7
■ INSTALLATION INSTRUCTIONS	
Location	8-9
Filter Cartridges	10
Electrical Requirements	11-13
■ STARTING YOUR SPA	14-16
■ 2009 SPA MODELS	17-37
Show™	17-19
Epic™	20-21
Destiny™	22-23
Euphoria™	24-25
Reward™	26-27
Resort™	28-29
Quest™	30-31
Promise™	32-33
Spirit™	34-35
Mirage™	36-37
Retreat™	38
Rendezvous™	39
Envy™	40
■ SPA CONTROL OPERATION	
Destiny, Euphoria, Resort, Reward, Mirage, Promise, Quest, Rendezvous, Retreat, Spirit and Envy.....	41-45
Epic and Show.....	46-50
Remote Controls.....	51
Aquavision Unit.....	51
Adagio™ Audio System.....	52
■ EQUIPMENT DIAGRAMS	
Envy, Mirage, Promise, Quest, Rendezvous, Retreat and Spirit.....	53
Destiny, Euphoria, Resort, Reward, Epic and Show.....	54
■ TROUBLESHOOTING	55-58
LCD Diagnostic Messages	56-57
Maintenance Reminders.....	58
■ SPA CARE AND ENJOYMENT GUIDE	59-66
■ MAINTENANCE	67-71
■ OWNER'S PROTECTION PLAN	72-74
■ ADAGIO™ AND AQUAVISION LIMITED WARRANTY	75-76

The following instructions contain important safety information. We strongly encourage you to read and apply them.

IMPORTANT SAFETY INSTRUCTIONS

WHEN INSTALLING AND USING THIS ELECTRICAL EQUIPMENT, BASIC SAFETY PRECAUTIONS SHOULD ALWAYS BE FOLLOWED, INCLUDING THE FOLLOWING:

1. READ AND FOLLOW ALL INSTRUCTIONS

2. **WARNING:** To reduce the risk of injury, do not permit children to use this product unless closely supervised at all times.
3. **DANGER: RISK OF CHILD DROWNING.** Extreme caution must be exercised to prevent unauthorized access by children. To avoid accidents, ensure that children cannot use the spa or hot tub unless they are supervised at all times.

120 VOLT, CORD CONNECTED MODELS

4. **DANGER: RISK OF INJURY.** Connect only to a grounded source.
5. Do not bury the power cord.
6. **WARNING:** To reduce the risk of electric shock, replace a damaged cord immediately.
7. A ground terminal (pressure wire connector) is provided on the surface of the control box inside the equipment compartment. This connector should be bonded with a minimum No. 8 AWG (8.4mm²) (No. 6 AWG in Canada) solid copper wire between this unit and any metal ladders, metal water pipes, metal enclosures of electrical equipment, conduit, or metal equipment within five feet (1.5m) of the spa. If the spa is located on a reinforced concrete pad, the reinforcing steel should also be bonded to the ground terminal.
8. **WARNING:** Your spa may be equipped with a ground fault circuit interrupter (GFCI) on the end of the power supply cord. Before each use of the spa, with the plug connected to the power supply and the unit operating, press the "test" button. The unit should stop operating and the GFCI power indicator will go out. Wait thirty seconds and then reset the GFCI by pressing the "Reset" button. The GFCI power indicator will turn on, restoring power to the spa. If the interrupter does not perform in this manner, it is an indication of an electrical malfunction and the possibility of an electric shock. Disconnect the plug from the receptacle until the fault has been identified and corrected.



240 VOLT, PERMANENTLY INSTALLED OR CONVERTED MODELS

9. A ground terminal is provided on the terminal block (TB-1, terminal 7) located inside the control box. To reduce the risk of electric shock, connect this terminal to the grounding terminal of your electrical service or supply panel with a continuous green, insulated copper wire. The wire must be equivalent in size to the circuit conductors supplying the equipment. In addition, a bonding terminal (pressure wire connector) is provided on the outside of the control box for bonding to local ground points. To reduce the risk of electric shock, this connector should be bonded with a No. 8 AWG (8.42mm²) (No. 6 AWG in Canada) solid copper wire to any metal ladders, water pipes, or other metal within five feet (1.5m) of the spa to comply with local requirements.
10. Your spa uses ground fault circuit interrupters in the electrical sub-panel. Before each use of the spa and with the unit operating press the Test button on each breaker. The switch should click over to the "Trip" position. Wait thirty seconds and reset each GFCI breaker by switching it completely off and then completely on. The switch should then stay on. If either of the interrupters does not perform in this manner, it is an indication of an electrical malfunction and the possibility of an electric shock. Disconnect the power until the fault has been identified and corrected.

ALL SPA MODELS

11. Install the spa so proper drainage is provided.
12. **DANGER: RISK OF ELECTRIC SHOCK.** Install the spa at least five feet (1.5m) away from metal surfaces, in accordance with the National Electric Code ANS/NMFA70-1993. Each metal surface must be permanently connected to a minimum No. 8 (8.42mm²) (No. 6 AWG in Canada) solid copper conductor attached to the wire bonding connector on the terminal box provided for this purpose.
13. **DANGER: RISK OF ELECTRIC SHOCK.** Do not permit any appliance, such as a light, telephone, radio, or television, etc. within five feet (1.5m) of the spa or hot tub.
14. **WARNING:** To reduce the risk of injury:
 - Water temperatures between 100°F (38°C) and 104°F (40°C) are considered safe for a healthy adult. Lower water temperatures are recommended for extended use (exceeding 10 minutes) and for young children.
 - Since excessive water temperatures have a high potential for causing fetal damage during the early months of pregnancy, pregnant or possibly pregnant women should limit spa water temperatures to 100°F (38°C).
 - Before entering a spa, the user should measure the water temperature with an accurate, waterproof, fever thermometer since the tolerance of temperature-regulating devices may vary as much as +/- 5°F (3°C).
 - The use of drugs, alcohol, or medication before or during spa use may lead to unconsciousness with the possibility of drowning.
 - Persons suffering from obesity or with a medical history of heart disease, low or high blood pressure, circulatory system problems, or diabetes should consult a physician before using the spa.



SAFETY INSTRUCTIONS

- Persons using medications should consult a physician before using a spa since some medication may induce drowsiness while other medication may affect heart rate, blood pressure, and circulation.
- 15. **DANGER: TO REDUCE THE RISK OF INJURY TO PERSONS.** Do not remove the suction fittings.
- 16. **DANGER: RISK OF INJURY:** Never operate a spa if the suction guard(s) is broken or missing. Never replace a suction guard with one rated less than the flow rate marked on the original suction guard. The suction guard(s) in the spa are sized to match the specific water flow created by the pump. Should the need arise to replace the suction guard(s) or the pump, be sure that the flow rates are compatible.
- 17. **DANGER:** Children are especially sensitive to hot water. At no time should children have unsupervised access to the spa. Children must not be allowed to climb onto the spa cover. All Marquis spas are equipped with a locking cover that meets the ASTM F1346-91 Standard for Safety Covers. Always lock the child resistant locks after using the spa for your children's safety.

18. **SAVE THESE INSTRUCTIONS.**

WARNING: Do not permit electric appliances (such as a light, telephone, radio, or television) within five feet (1.5m) of the spa or hot tub.

WARNING: Children should not use spas or hot tubs without adult supervision.

WARNING: Do not use spas or hot tubs unless all suction guard(s) are installed to prevent body and hair entrapment.

WARNING: Do not use drugs or alcohol before or during the use of a spa or hot tub to avoid unconsciousness and possible drowning.

WARNING: People using medications and/or having an adverse medical history should consult a physician before using a spa.

WARNING: The use of alcohol, drugs, and medication can greatly increase the risk of fatal hyperthermia.

WARNING: Before entering the spa or hot tub measure the water temperature with an accurate thermometer.

WARNING: Water temperature in excess of 104°F (40°C) may be injurious to your health.

WARNING: Prolonged immersion in a spa or hot tub may be injurious to your health.

WARNING: People with infectious diseases should not use a spa.

WARNING: Pregnant or possibly pregnant women should consult a physician before using a spa or hot tub.

WARNING: To avoid injury, exercise care when entering and exiting the spa or hot tub.

WARNING: Do not use a spa or hot tub immediately following strenuous exercise.

WARNING: Maintain water chemistry in accordance with manufacturer's instructions.

SAFETY INSTRUCTIONS FOR FRENCH SPEAKING SPA OWNERS

AVERTISSEMENT: Ne pas placer d'appareil électrique (luminaire, téléphone, radio, téléviseur, etc.) moins de 1.52 m de cette cuve de relaxation.

AVERTISSEMENT: Ne pas laisser les enfants utiliser une cuve de relaxation sans surveillance.

AVERTISSEMENT: Pour éviter que les cheveux ou une partie du corps puissent être aspirés, ne pas utiliser une cuve de relaxation si les grilles de prise d'aspiration ne sont pas toutes en place.

AVERTISSEMENT: Pour éviter l'évanouissement et la noyade éventuelle, ne prendre ni drogue ni alcool avant d'utiliser une cuve de relaxation ni quand on s'y trouve.

AVERTISSEMENT: Les personnes qui prennent des médicaments ou ont des problèmes de santé devraient consulter un médecin avant d'utiliser une cuve de relaxation.

AVERTISSEMENT: La consommation d'alcool ou de drogue augmente considérablement les risques d'hyperthermie motrice dans une cuve de relaxation.

AVERTISSEMENT: Avant d'utiliser une cuve de relaxation mesurer la température de l'eau l'aide d'un thermomètre précis.

AVERTISSEMENT: Il peut être dangereux pour la santé de se plonger dans de l'eau plus de 40°C.

AVERTISSEMENT: L'utilisation prolongée d'une cuve de relaxation peut être dangereuse pour la santé.

AVERTISSEMENT: Les personnes atteintes de maladies infectieuses ne devraient pas utiliser une cuve de relaxation.

AVERTISSEMENT: Les femmes enceintes, que leur grossesse soit confirmée ou non, devraient consulter un médecin avant d'utiliser une cuve de relaxation.

AVERTISSEMENT: Pour éviter des blessures, user de prudence en entrant dans une cuve de relaxation et en sortant.

AVERTISSEMENT: Ne pas utiliser une cuve de relaxation immédiatement après un exercice fatigant.

ATTENTION: La teneur de l'eau en matières dissoutes doit être conforme aux directives du fabricant.

PERSONAL SAFETY

Prolonged immersion in hot water can result in **HYPERTHERMIA**, a dangerous condition which occurs when the internal temperature of the body reaches a level above normal (98.6°F, 37°C). The symptoms of hyperthermia include dizziness, fainting, drowsiness, lethargy, and a body temperature above 98.6°F (37°C). The physical effects of hyperthermia include unawareness of impending hazard, failure to perceive heat, failure to recognize the need to exit the spa, physical inability to exit the spa, fetal damage in pregnant women, and unconsciousness resulting in a danger of drowning.

Other booklets about spa safety are: “Children Aren’t Waterproof,” “Pool and Spa Emergency Procedures For Infants and Children,” “Layers of Protection” and “The Sensible Way to Enjoy Your Spa” published by APSP.

WARNING: The use of alcohol, drugs, or medication can greatly increase the risk of fatal hyperthermia in hot tubs and spas.

Persons taking medications which induce drowsiness such as tranquilizers, antihistamines, or anticoagulants should not use the spa. Pregnant women and persons with a medical history of heart disease, diabetes, or high blood pressure should consult a physician before using the spa.

PERSONAL SAFETY DOs:

- Be sure your spa is connected to the power supply correctly – only use a licensed electrical contractor.
- Shut off power supply (unplug 120V models) before draining the spa or servicing the electrical components.
- Test the Ground Fault Circuit Interrupter (GFCI) monthly.
- Always test the water temperature with an accurate thermometer before entering the spa to be sure that it’s a safe temperature.
- Do not use the spa if water temperature is outside of set temperature. Remember that wet surfaces can be very slippery. Take care when entering and exiting the spa.
- Lock the DuraCover™ when the spa is not in use, whether it is empty or full of water.
- Keep the water clean and sanitized with correct chemical care.
- Turn on the jets when adding ANY chemicals to the spa water.
- Clean the filter cartridge(s) monthly to remove debris and mineral buildup which affects the performance of the hydrotherapy jets, limits the flow, or trips the high limit thermostat which will turn off the entire spa.

PERSONAL SAFETY DO NOTs:

- Don’t use the spa with the equipment compartment door removed.
- Don’t use the spa for more than 10 minutes of time at water temperatures in excess of 102°F (39°C).
- Don’t allow the jet pump(s) to operate for an extended period of time with the cover in place. Extended pump operation causes a slow heat buildup due to water friction. The spa equipment controls are equipped with a built-in safety timer that automatically shuts off the jet pump(s) after 15 minutes of continuous operation should it have been left on inadvertently.
- Don’t operate the spa at any time with the filter cartridges removed.
- Don’t lift or drag the cover by using the tie-down straps; always lift and carry by using the external handles.
- Don’t store chemicals in the spa’s equipment compartment.
- Don’t hesitate to call your authorized dealer with any questions or maintenance concerns.

LOCATION

For your portable spa to function properly and safely, it must be located on a hard, flat, level surface. Inground spas require special installation techniques and should be planned in conjunction with your authorized Marquis Spas® dealer. Improper installation can result in structural damage to the spa and the voiding of your spa warranty. Items to discuss with your dealer include: Local construction codes, electrical service requirements, serviceability of equipment, present underground obstructions such as gas, water, and telephone lines, safety measures such as fences and locks, and visibility of the spa installation from the home, street, and neighbors.

Do not shim your spa. If your pad is not level you must pour a top cap: contact a professional.

- Allow for sufficient water drainage around the spa to help preserve the equipment and support structure. This includes indoor installations.
- A filled spa can weigh up to 5,000 pounds and the location should support the weight of the filled spa.
- Locate the equipment compartment where it will be accessible. Your spa **MUST** be installed to permit access for servicing the equipment above and/or below any decks or floors. Access is essential and must allow adequate room for service. To facilitate repairs, Marquis Corp. or its agent may require access to spa equipment. It is your responsibility to provide unencumbered access. See spa diagrams for location of power supply.
- Leave access to the circuit breakers in the sub panel (240V models) or to the interrupter switch (GFCI, 120V models) on the end of the power cord.
- Be sure the spa is level and in the final position **BEFORE** filling with water. Check for power cords, tools, and hoses that may be caught underneath the spa. Do not apply power to the spa before it is completely filled with water. Damage to the pumps, heater and sensors may result.
- **IMPORTANT: DO NOT LET AN EMPTY SPA REMAIN EXPOSED TO DIRECT SUNLIGHT.**
Spa surface temperatures can reach in excess of 180°F (82°C) if left exposed to the sun. Significant damage can occur if this is allowed to happen, including warping and blistering of the surface. Damage, that occurs as a result of this exposure, is not covered under the warranty.
- **CAUTION:** Never try to move a spa that has not been fully drained. To do so could result in damage to the spa and physical injury to the mover. Cracks in the spa surface, exterior siding or DuraBase due to improper transport or support of the spa are not covered under the warranty.



OUTDOOR AND PATIO INSTALLATION

To install the spa outdoors, we recommend a reinforced concrete pad at least four inches thick. The reinforcing material should be attached to a #8 AWG bonding wire per national and local electrical code.

If you place the spa on the ground, even temporarily, place the spa empty of water on concrete pavers under the entire bottom of the spa. The concrete pavers should be a least two inches thick and level across the entire surface. The spa will inevitably settle and not remain level on this surface, thus it's important to get the spa onto a solid foundation as soon as possible.

DECK INSTALLATION

Be sure the deck can support the weight of your filled spa by checking the deck's maximum load capacity. Consult a qualified building contractor or structural engineer. Minimum requirement is 100 pounds per square foot.

INDOOR INSTALLATION

There are special requirements if you place your spa indoors. Flooring material must provide adequate traction when wet. Proper drainage is essential to prevent water puddling. Proper ventilation to the area is required. The addition of a ventilation system is recommended. Please see your contractor for details.



Shut-off valve in open position

SHUT-OFF VALVES

Your spa is equipped with shut-off valves (see EQUIPMENT DIAGRAM) that shut off the water flow to the equipment system for authorized Marquis Spas® dealer service. At times, a new spa or one that has recently been serviced, may have the shut-off valves partially closed which can restrict the water flow and hinder jet performance. Be sure the valves are fully open.

FREEZE PROTECTION

When a freeze condition is detected (which occurs when the temperature in the heater housing drops to 55°F, (13°C) the jet pump(s) is automatically activated. In areas with extremely cold winter conditions, your spa should be fine as long as it is left running at normal operating temperatures. For extra protection see your dealer for an optional freeze sensor. If you plan to turn the spa off, follow the instructions in this manual (see SUSPENDED USE OR WINTERIZING YOUR SPA).

OVERHEATING

In the case of extended hot weather, the spa water temperature may reach and maintain 104°F to 106°F (40°C to 41°C) or higher. This is due to the ambient temperature and the full insulation in the spa cabinet. You may have the option of shortening the pump-run time. See SPA CONTROL OPERATION for available options.



1) Center filter cartridge over canister



2) Screw filter cartridge in place

FILTER CARTRIDGES

Your portable spa is equipped with the Constant-Clean™ Filtration system. It features one or two Vortex filters.

NOTE: It is very important that the components of these filtration systems be installed properly in the proper part of the spa.

1. Hold the Vortex filter cartridge and center it in the opening of the filter housing.
2. Use the filter handle and turn the filter cartridge clockwise to screw it in place. (Use caution not to overtighten as damage may occur to threads and is not covered under warranty.)
3. Grasp the edge of the Vortex skimmer lid or Waterfall, center it over the rings and gently snap in place.



Safety guard of suction fitting must remain in place.

SUCTION GUARDS

The suction guard(s) in the footwell of your spa is an opening through which the jet pump(s) draws water. Suction fittings are equipped with a safety guard. Suction through the fittings can be strong. The safety guard(s) must remain in place and undamaged. A fitting with a damaged guard(s) can be dangerous, especially to small children or people with long hair. Should any part of the body become drawn to a fitting, turn the jet pump(s) off immediately. Long hair should be restrained. Never allow long hair to float freely in the spa. Replace any missing or damaged suction guard(s).

NOTE: It is normal for the flow rates of the suction fittings to vary from strong to barely noticeable.

ELECTRICAL REQUIREMENTS

It is the responsibility of the spa owner to ensure that all electrical connections are made by a qualified electrician in accordance with all national, state, and local electrical codes in effect at the time of installation. The recommended spa operating environment is - 5°C to +45°C, at 20-80 percent of relative humidity. Fuses are covered to be free of defect at time of installation only.

240 Volt

All connections must be made in accordance with the wiring diagram found on the inside of the control box cover. Connections must be made with copper conductors only – *do NOT use aluminum wire*. All conductors, circuit breakers, and fuses and the GFCI must be sized in accordance to the total amperage load as specified below.

Improperly wired spas can cause irreversible damage resulting in blown fuse and melted terminal block, and to other electrical components. Also, damage caused to components or equipment caused by high or low voltage, brown outs or electric surges is not covered under warranty.

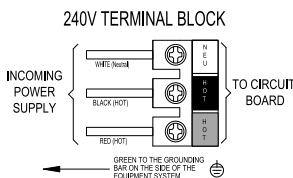

- Permanently connected (Hard wired).
- Rated 240V, 60Hz, 50A, three wires (#6 copper) plus ground (#8 copper), [4 wires total].
- Circuit breaker or fuse size: 50A.
- A disconnecting means must be installed within sight from the equipment and at least 5 feet (1.52m) from the inside walls of the spa.
- Connect only to a circuit protected by a Class A ground Fault Circuit Interrupter (GFCI).

- For units used in other than single-family dwellings, a clearly labeled emergency switch shall be provided as part of the installation. The switch shall be readily accessible to the occupants and shall be installed at least five feet (1.52 m) away, adjacent to, and within sight of the unit.
- A pressure wire connector is provided on the exterior of the control box to allow connection of a bonding wire to any metal ladder, metal water pipe, common bonding grid (reinforced concrete slab, ground plate beneath the spa), or any other metal within 5 feet (1.52 m) of the spa. The bonding wire shall be copper and at least #8 AWG (8.42mm²), #6 in Canada.

NOTE: Ensure the GFCI is properly installed. Failure to do so may result in spa malfunction or damage which is not warranted. Ground Fault Circuit Interrupters are available from your Marquis Spas dealer.

⚠ ATTENTION The **Epic** and **Show** models are equipped with a GFCI Trip Test that must be performed to assure safety and allow proper spa function.

AUTOMATIC TEST: Approximately 24 hours following startup, the spa will trip the GFCI, testing it to insure it is functioning properly (do not call your dealer; this is a signal that the spa is wired correctly). After the trip test is complete, reset the GFCI as per the manufacturer's instructions and the spa will function normally.

-OR- MANUAL TEST: The installer can manually initiate the GFCI Trip Test at start up with a button sequence on the control panel.

1. Press TEMP+, then JETS 1, then SPA LIGHT.
2. Press TEMP+ repeatedly until "gFC" is displayed, then press JETS 1.
3. Press TEMP+ until "Gt.n" is displayed, then press JETS 1 to initiate the test.

The GFCI should trip within several seconds and the spa should shut down. After the trip test is complete, reset the GFCI as per the manufacturer's instructions and the spa will function normally. If the test does not trip the GFCI, manually shut down the power and verify that a GFCI breaker is installed and that the circuit, GFCI, and spa are wired correctly. Restore power to the spa and verify the function of the GFCI with its own test button. Reset the GFCI and repeat the GFCI Trip Test.

After passing the GFCI trip test, subsequent GFCI trips indicate a ground fault or other unsafe condition, requiring the power to the spa to be shut off. You can verify a successful test by navigating to the "gFC" item as described above, pressing JETS 1 and then pressing TEMP+ until you see "gS.P", a code that signifies "GFCI Status - Passed".

⚠ WARNING: The GFCI Trip Test does NOT take the place of locating, testing, and resetting the GFCI on a regular basis to verify its function.

If the spa is to be rewired, moved, or resold, the GFCI Trip Test should be reset so it will test the new GFCI. The "GFCI status - Passed" must be cleared before the test can be run.

1. Press TEMP+, then JETS 1, then SPA LIGHT.
2. Press TEMP+ repeatedly until "gFC" is displayed, then press JETS 1.
3. Press TEMP+ until "gC.n" is displayed, then press JETS 1 to clear the GFCI Status; you will see gS.A" displayed verifying that the GFCI Status has been set to "Armed". System will exit in 30 seconds if no buttons are pressed.

*When you enter the GFCI menu, it always shows you the current status first. "gS.P" means that it's Passed (and will do no further automated GFCI Trip Tests), "gS.A" means that it's Armed (and will do an automated GFCI Trip Test in 24 hours, unless a manual GFCI Trip Test is done before that). ("gS.t", which you are unlikely to see unless you've just initiated a Trip manually, means that it's about to Trip within the next dozen seconds or so.) GFCIs are available from your authorized dealer.

120 Volt

120 Volt spas shall be plugged into a properly grounded, grounding type 15 amp receptacle on a dedicated circuit. A dedicated circuit is a circuit with no other components that consume power, such as lights, televisions, radios, computers, or other electronic devices. These could cause your spa to malfunction by any of the following: unusual text on the control panel, slow heating, poor jet action, tripping house breaker, or blown fuses. Failure to follow these instructions could lead to premature failure of spa components that would not be covered under the warranty. The dedicated circuit shall meet the following specifications:

- Rated 120V, 60Hz, 15A (2 wires plus ground)
- Circuit breaker or fuse size: 15A
- The receptacle must be at least 5 feet (1.52 m) from the spa.
- The 15 foot GFCI power cord provided with the spa must be plugged directly into the receptacle. Do NOT use an extension cord or any other adaptor. Actual exposed length of cord will vary by model, but will never be less than 12 feet.

Convert 120 Volt to 240 Volt

120 Volt spas may be converted to operate on 240V, 50A. All connections must be made by a licensed electrician.

1. Disconnect the power by unplugging the power cord from the receptacle, removing the cord from the terminal block on the circuit board, and storing it with your owner's manual.
2. Locate the white wire connecting J11 to J32 on the circuit board. Remove the wire and discard.
3. For 50A operation, move dip switch 10 to the OFF position.
4. Install 240V power as indicated in the 240 Volt section.
5. Rated 240V, 60Hz, 50A, three wires (#6 copper) plus ground (#8 copper), [4 wires total].

Improperly wired spas are beyond Marquis Corp. control and are not covered under the warranty. Other items beyond Marquis Corp. control include, but are not limited to, damage resulting from: improper connections; accidents; failure to follow procedures and instructions defined in the Marquis Spas® printed instructions; cleaning agents; and natural occurrences including but not limited to rodent or insect infestation, mold, lightning and other acts of nature.

STARTUP PROCEDURE

Your spa is equipped with solid-state Comfort Controls specific to your spa model. (See **SPA CONTROL OPERATION** for your specific spa model.)

To start your spa, you need spa test strips. It is important to follow each of these steps when starting your spa. Once you have completed the following steps, see **MARQUIS CARE AND ENJOYMENT GUIDE** for proper water treatment.

NOTE: Your spa has been filled and test-run at the factory. The first time your spa is filled with water, some discoloration from residual test water may appear. This will disappear when the spa is completely filled and the filtration system is functioning.

WARNING: Spa must be completely filled with water before turning on power.

Test the water for the proper chemical balance and adjust as necessary. SpaCare products are recommended. (See **WATER TREATMENT**.)

PROPER CHEMICAL BALANCE IS IMPORTANT for your safety and the longevity of your spa.

In the case of relocating your spa, it is imperative to follow the instructions in the owner's manual. These instructions must remain with the spa. Damage caused by relocating spa is not covered under warranty.

THERAPY PUMP(S)

Allow the spa to circulate on high-speed (see **SPA CONTROL OPERATION**) for four to five minutes to discharge air from the plumbing system. Do not expect hot water immediately from the jets; the heater will take several hours to heat the water.

Startup procedure for all models

1. Place spa on a hard, flat, level surface. Make sure the power supply is off.
2. Make sure the suction guard(s) in the footwell are in place and undamaged.
3. Open the equipment door. Tighten all disconnects and open all shut-off valves.

NOTE: Keep the drain valve closed at all times except when draining the spa (do not rely on the cap to stop the flow of water). Not doing so could result in damage to the drain valve due to freezing water.



Fill spa with water to two-thirds of the way up the Vortex skimmer opening.

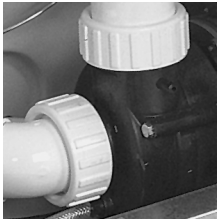

Vent air by slightly opening pump unions.



Use TEMP pad to set water temperature.

4. Install filter cartridges. (See **INSTALLATION INSTRUCTIONS**, Filter Cartridges.)
5. Fill the spa with water to two-thirds of the way up the Vortex skimmer openings. The use of a *Fill Filter* is recommended, especially in areas with high mineral content in the water.
6. Turn the power on.
7. Your spa is now in “pump priming” mode and a “Pr” message displays in the LCD window of the control panel. While in this mode the spa appears idle, which lasts approximately four to five minutes if not exited manually. To exit manually, press the TEMP pad.
8. Allow the spa to circulate on high-speed (see **SPA CONTROL OPERATION**) for four to five minutes to discharge air from the plumbing system. Do not expect hot water immediately from the jets; the heater will take several hours to heat the water.
9. At this time the spa should have water flowing from the jets. If the pump has not primed and the water is not flowing from the jets after two minutes **TURN OFF POWER TO THE SPA** and vent air from the pumps by slightly opening the pump unions. After turning the power on again, the spa initiates a new priming mode. Repeat steps above.
10. The system requires approximately two minutes of water flow to determine the water temperature. After two minutes of water flow, the temperature is displayed as actual water temperature. After you have manually exited the priming mode (or allowed the spa to automatically exit) the LCD window momentarily displays 100°F (38°C) and then the display switches to - - °F.
11. The factory default setting for water temperature is 100°F (38°C). Use the TEMP pad on the control panel to set the water temperature to the desired level. (See **SPA CONTROL OPERATION**.) It takes up to 24 hours to heat the water to desired temperature depending on the water temperature and voltage of your spa.

DURACOVER™

When the spa is not in use, the DuraCover should be kept on the spa to retain the water’s heat and to keep out dirt, leaves, etc.

For your safety and convenience, the cover is equipped with adjustable straps, safety locks, and handles. Use the exterior handles to remove and replace your cover. Never attempt to open or remove the cover by grasping or pulling on the cover skirting or cover lock straps as the skirting will tear.

Marquis suggests you use the safety locks to help keep out unintended users, prevent covers from being blown off in windy conditions and to maximize heat retention/energy efficiency. The cover and retractable cover system are not recommended for use in wind conditions reaching above 25 miles per hour. If your spa is located in an area susceptible to high winds, additional cover lock straps may be necessary to minimize cover damage.

Open the spa cover:

1. Unfasten all cover lock straps.
2. Place one hand under the cover skirting, between the spa and cover, to break the cover's vacuum seal. Do not use cover handles to break vacuum seal.
3. Fold the front half of the cover over onto the back half.

NOTE: Unlock and release all cover locks before attempting to open cover. Damage caused by attempting to open the cover while locked or by wind is not covered under warranty. Do not walk, stand, climb, or sit on the vinyl cover or retractable cover system. Do not use hard, sharp, or metal objects, such as a windshield scraper, to remove ice. Such objects can cut, mar, or puncture the cover's vinyl surface.

Close the spa cover:

1. Place one hand on the upper corner of the cover and gently push forward in the direction of the spa. The cover will rotate forward to cover half of the spa.
2. Unfold the cover by lifting the handle located on the top (front) half of the cover. Allow the unfolded half to fall down onto the spa.
3. Secure the cover lock straps to the spa and lock them.

NOTE: When opening a cover with a cover removal mechanism, use one of the manufacturer's recommended methods. Do not attempt to open the cover in any other way. Damage caused by improper opening or closing of the cover is not covered under the warranty.

Fading, staining, torn stitching of the spa cover and broken foam cores are not covered under the warranty if caused by improper use or maintenance. Spa covers do not qualify for labor coverage under the warranty. These parts can be purchased or exchanged under warranty at your authorized Marquis Spas® dealer.

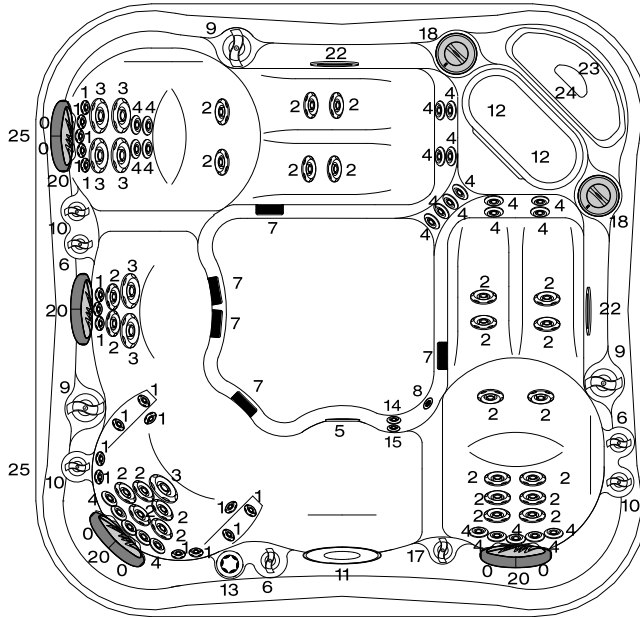

#	Component Identification	Qty.
0	HK™8 Neck Jets	6
1	HK™8 Jets	18
2	HK™12 Jets	25
3	HK™16 Jets	7
4	HK™40 Jets	26
5	Light (option)	1
6	Air Controls	3
7	Suction Fittings	5
8	Floor Drain	1
9	Jet Selectors	3
10	Neck Jet Valves	3
11	Bather's Control Panel	1
12	Filter Canisters	2
13	Spa Frog®	1
14	Spa Frog® Return Fitting	1
15	Ozone Injector Fitting	1
17	Waterfall Valve	1
18	Adagio™ Speakers (option)	2
19	Constellation™ (option)	16
20	Cushioned Headrests	4
22	Water Features	2
23	Cooler	1
24	TV (option)	1
25	Auxiliary Pump Interior Locations	2
Physical Specifications		Size
Dimensions		90" x 94"
Height		35"
Corner Radius		17"
Seating Capacity/Positions		5/5
Weight Dry/Lbs.		1100
Weight Full/Lbs.		5062
Water Capacity/Gallons		475
Total Therapy Jets		82



SHOW™ THERAPY CONTROL

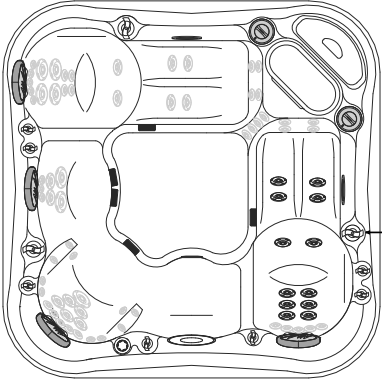

ZONE 1 (JETS 1)
Adirondack A: all back, hips, legs and feet

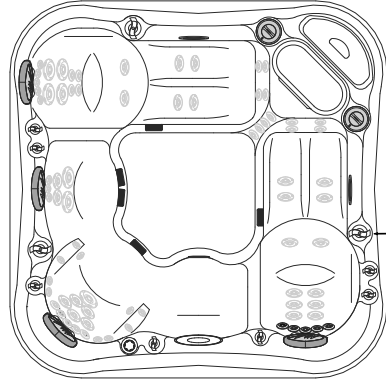

ZONE 4 (JETS 1)
Adirondack A: upper-back

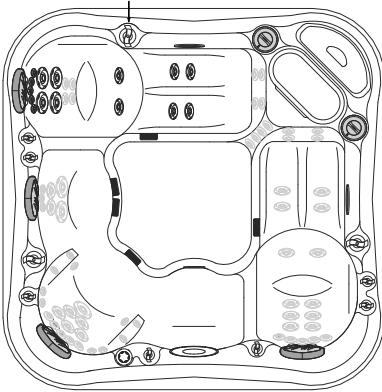

ZONE 2 (JETS 2)
Adirondack B: upper- and mid-back, hips and feet

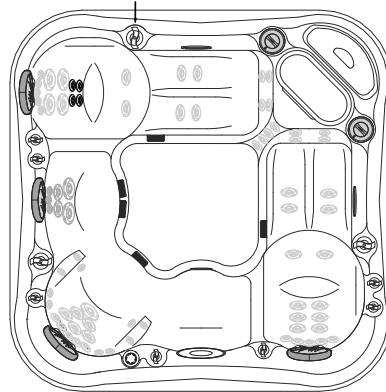

ZONE 5 (JETS 2)
Adirondack B: lower-back

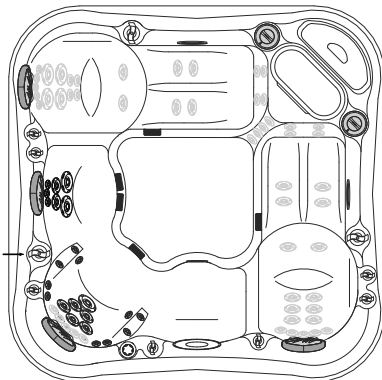

ZONE 3 (JETS 3)
Captain's chair: mid- and lower-back, arms, knees and wrists.
Seat: all back

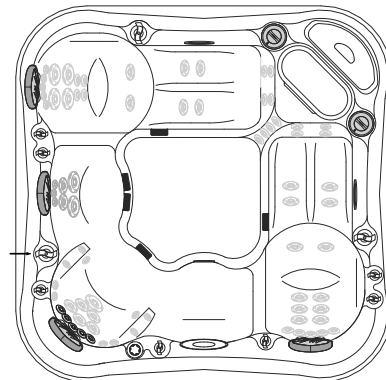

ZONE 6 (JETS 3)
Captain's chair: upper-back

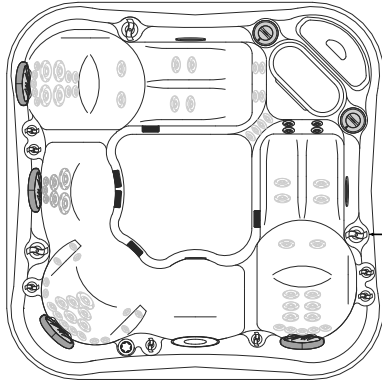

ZONE 7 (JETS 1)

Adirondack A: feet

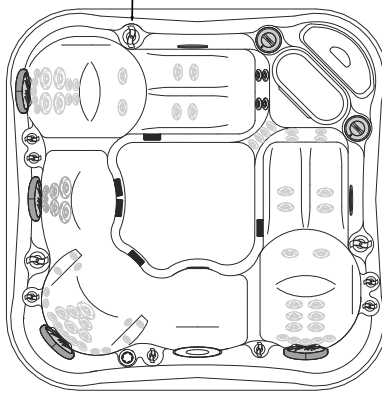

ZONE 8 (JETS 2)

Adirondack B: feet

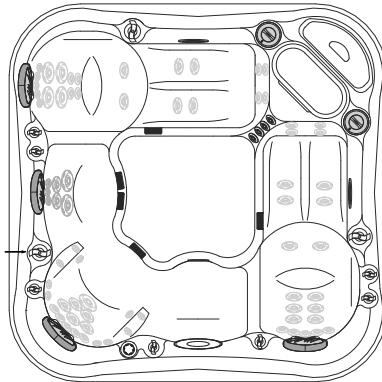

ZONE 9 (JETS 3)

Therapy pillar: legs and feet

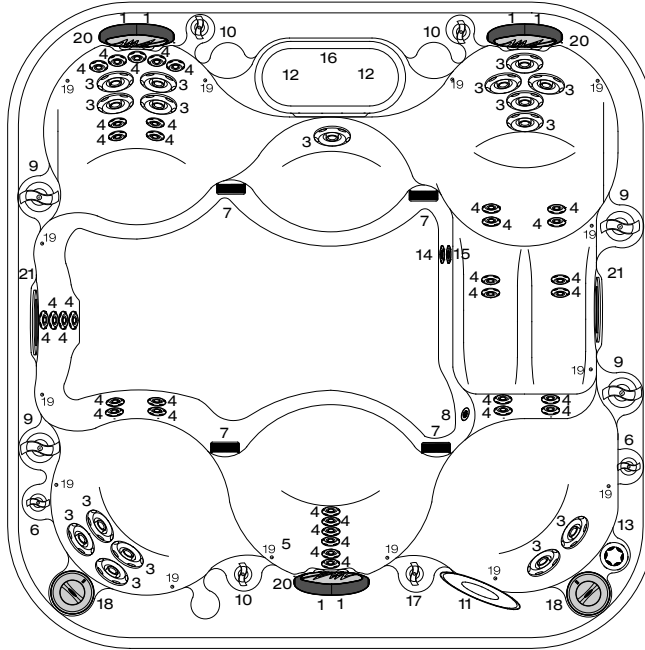

#	Component Identification	Qty.
1	HK™8 Neck Jets	6
3	HK™16 Jets	16
4	HK™40 Jets	35
5	Light (option)	1
6	Air Controls	2
7	Suction Fittings	4
8	Floor Drain	1
9	Tri-Zone Controls	4
10	Neck Jet Valves	3
11	Bather's Control Panel	1
12	Filter Canisters	2
13	Spa Frog®	1
14	Spa Frog® Return Fitting	1
15	Ozone Injector Fitting	1
16	Waterfall Feature	1
17	Waterfall Valve	1
18	Adagio™ Speakers (option)	2
19	Constellation™ (option)	17
20	Cushioned Headrests	3
21	Water Features	2
Physical Specifications		Size
Dimensions		90" x 90"
Height		35"
Corner Radius		17"
Seating Capacity/Positions		6/7
Weight Dry/Lbs.		850
Weight Full/Lbs.		4603
Water Capacity/Gallons		450
Total Therapy Jets		57

A (JETS 2)
 Tri-Zone A in
 position 1:
 Therapy Pillar*

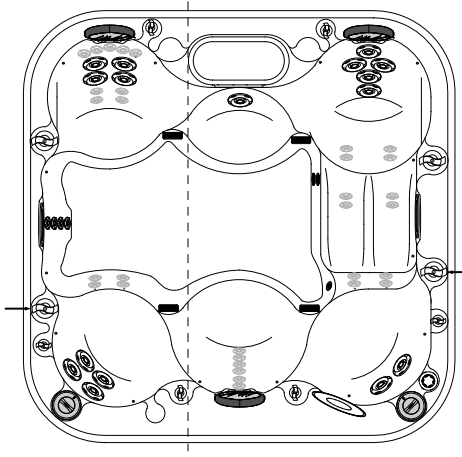

B (JETS 1)
 Tri-Zone B in
 position 3:
 Full-back*

A (JETS 2)
 Tri-Zone A in
 position 2:
 Overall-back*

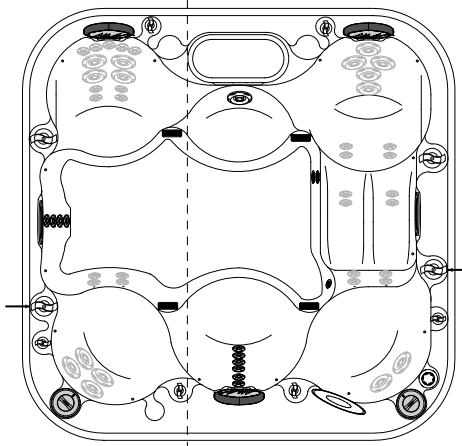

B (JETS 1)
 Tri-Zone B in
 position 2:
 Overall-back*

A+C (JETS 2)
 Tri-Zone A in
 position 3
 and Tri-Zone C in
 position 1: Feet*

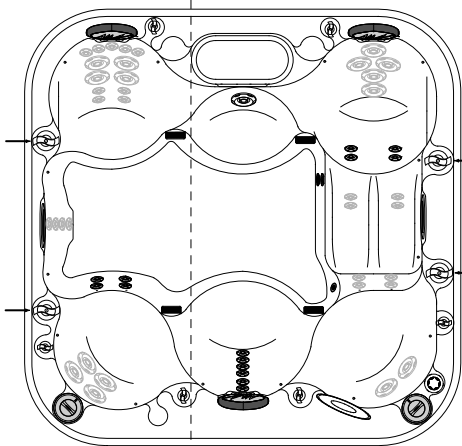

B+D (JETS 1)
 Tri-Zone B in
 position 1
 and Tri-Zone D in
 position 3:
 Thighs*

*HK8 neck jets
 operate in every
 zone

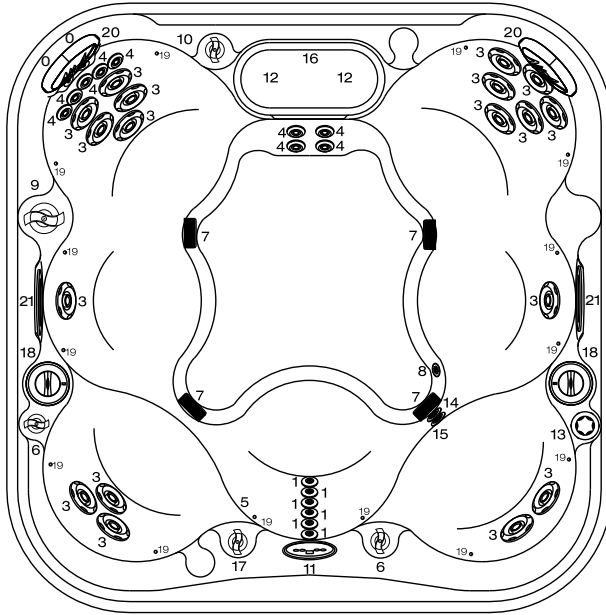

#	Component Identification	Qty.
0	HK™8 Neck Jets	2
1	HK™8 Jets	6
3	HK™16 Jets	18
4	HK™40 Jets	9
5	Light (option)	1
6	Air Controls	2
7	Suction Fittings	4
8	Floor Drain	1
9	Tri-Zone Control	1
10	Neck Jet Valve	1
11	Bather's Control Panel	1
12	Filter Canisters	2
13	Spa Frog® (option)	1
14	Spa Frog® Return Fitting (option)	1
15	Ozone Injector Fitting	1
16	Waterfall Feature (option)	1
17	Waterfall Valve (option)	1
18	Adagio™ Speakers (option)	2
19	Constellation™ (option)	16
20	Cushioned Headrests (option)	2
21	Water Features (option)	2
Physical Specifications		Size
Dimensions		84" x 84"
Height		35"
Corner Radius		17"
Seating Capacity/Positions		7/7
Weight Dry/Lbs.		800
Weight Full/Lbs.		3885
Water Capacity/Gallons		370
Total Therapy Jets		35

DESTINY™ THERAPY CONTROL

**ZONE 1
(JETS 1)**
Mid- and lower-back jets.*

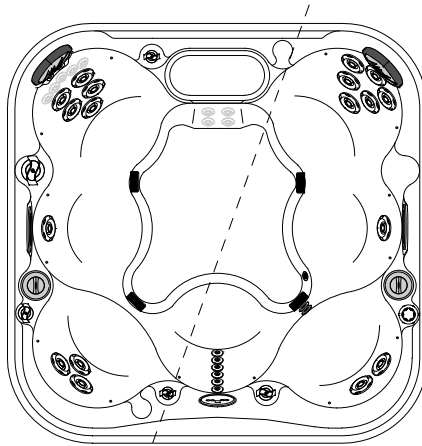

**ZONE 4
(JETS 2)**
Upper-, mid-, and lower-body jets.*

**ZONE 2
(JETS 1)**
Upper-body jets.*

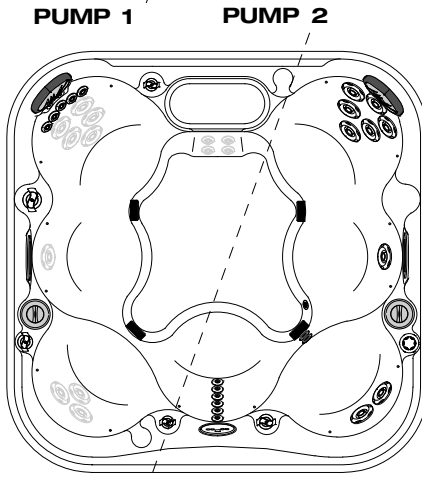

**ZONE 5
(JETS 2)**
Upper-, mid-, and lower-body jets.*

**ZONE 3
(JETS 1)**
Lower-body jets.*

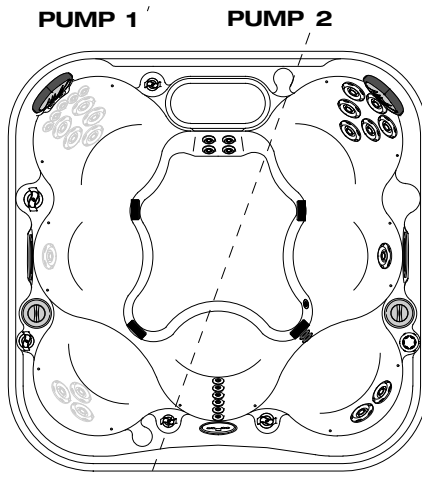

**ZONE 6
(JETS 2)**
Upper-, mid-, and lower-body jets.*

*HK8 neck jets operate in every zone.

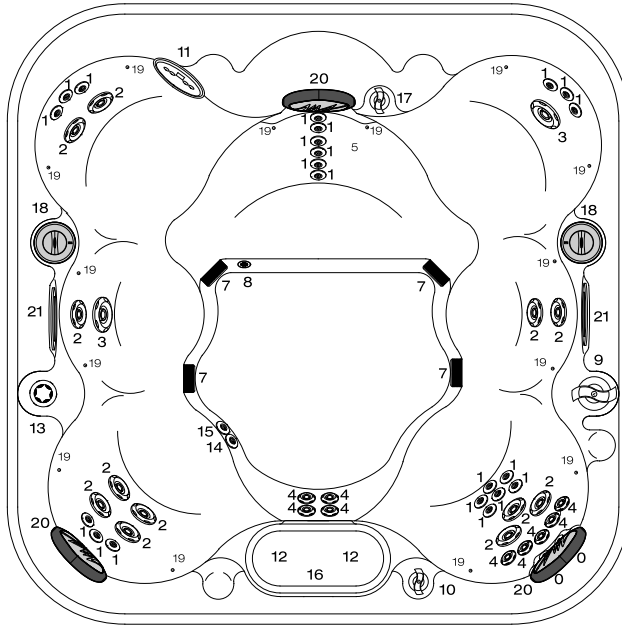

#	Component Identification	Qty.
0	HK™8 Neck Jets	2
1	HK™8 Jets	21
2	HK™12 Jets	12
3	HK™16 Jets	2
4	HK™40 Jets	9
5	Light (option)	1
7	Suction Fittings	4
8	Floor Drain	1
9	Jet Selector	1
10	Neck Jet Valve	1
11	Bather's Control Panel	1
12	Filter Canisters	2
13	Spa Frog® (option)	1
14	Spa Frog® Return Fitting (option)	1
15	Ozone Injector Fitting	1
16	Waterfall Feature (option)	1
17	Waterfall Valve (option)	1
18	Adagio™ Speakers (option)	2
19	Constellation™ (option)	17
20	Cushioned Headrests (option)	3
21	Water Features (option)	2
Physical Specifications		Size
Dimensions		90" x 90"
Height		35"
Corner Radius		17"
Seating Capacity/Positions		7/7
Weight Dry/Lbs.		825
Weight Full/Lbs.		4161
Water Capacity/Gallons		400
Total Therapy Jets		46



EUPHORIA™ THERAPY CONTROL

**ZONE 1
JETS 2**
Upper-,
mid- and
lower-body
jets.*

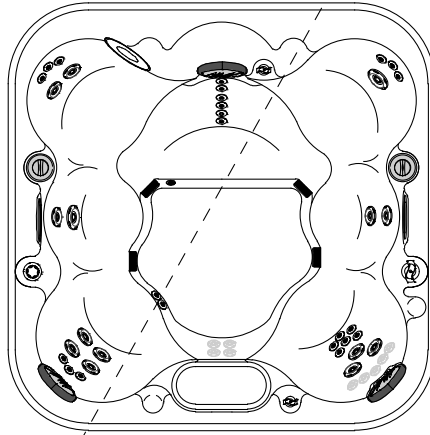

PUMP 2

PUMP 1

**ZONE 1
JETS 1**
Upper-,
mid- and
lower-back
jets.*

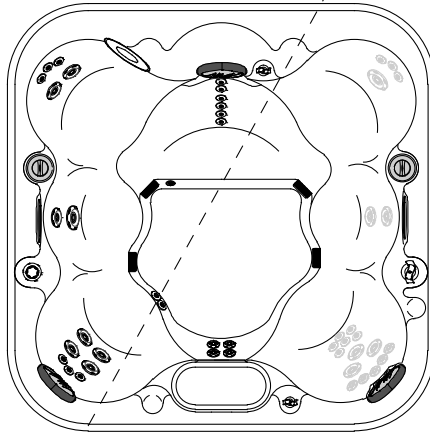

PUMP 2

PUMP 1

**ZONE 2
JETS 1**
Lower-
body jets.*

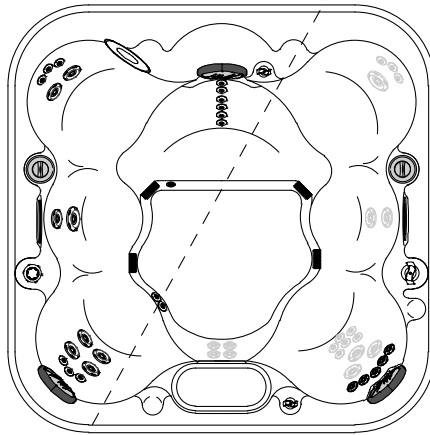

PUMP 2

PUMP 1

**ZONE 3
JETS 1**
Upper-back
jets.*

*Neck jets
operate in
all zones.

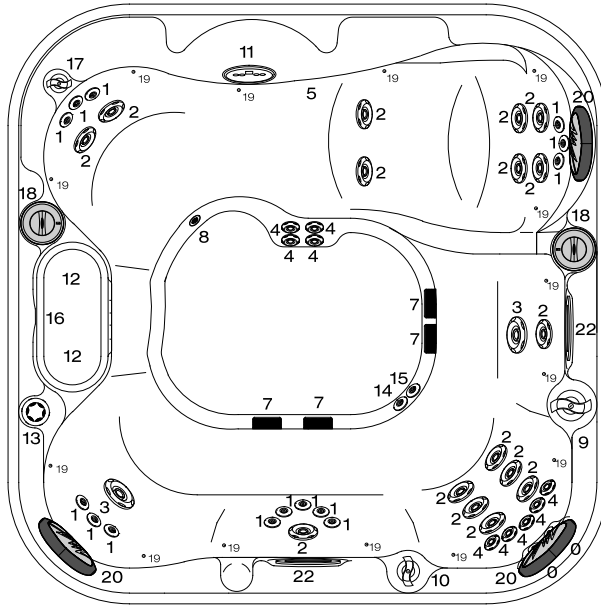

#	Component Identification	Qty.
0	HK™8 Neck Jets	2
1	HK™8 Jets	14
2	HK™12 Jets	16
3	HK™16 Jets	2
4	HK™40 Jets	9
5	Light (option)	1
7	Suction Fittings	4
8	Floor Drain	1
9	Jet Selector	1
10	Neck Jet Valve	1
11	Bather's Control Panel	1
12	Filter Canisters	2
13	Spa Frog® (option)	1
14	Spa Frog® Return Fitting (option)	1
15	Ozone Injector Fitting	1
16	Waterfall Feature (option)	1
17	Waterfall Valve (option)	1
18	Adagio™ Speakers (option)	2
19	Constellation™ (option)	17
20	Cushioned Headrests (option)	3
22	Water Features (option)	2
Physical Specifications		Size
Dimensions		84" x 84"
Height		35"
Corner Radius		17"
Seating Capacity/Positions		6/6
Weight Dry/Lbs.		740
Weight Full/Lbs.		3659
Water Capacity/Gallons		350
Total Therapy Jets		43



REWARD™ THERAPY CONTROL

ZONE 1
JETS 2
Upper,
mid- and
lower-back
jets*

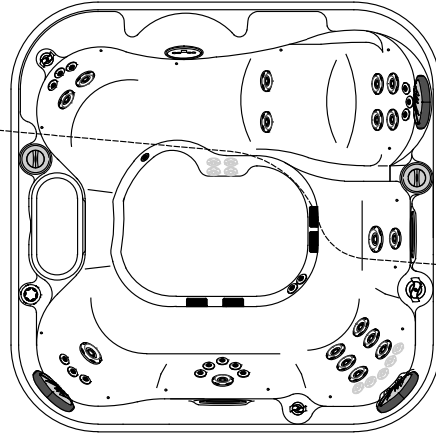

ZONE 1
JETS 1
Upper,
mid- and
lower-back
jets*

PUMP 2

PUMP 1

ZONE 2
JETS 1
Upper-back
jets*

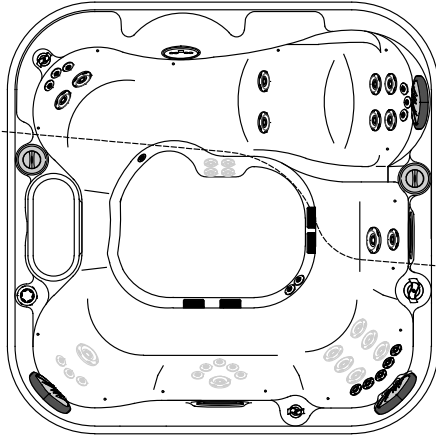

PUMP 2

PUMP 1

ZONE 3
JETS 1
Lower-
body jets*

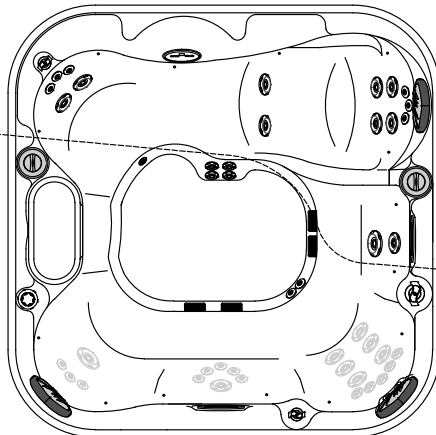

PUMP 2

PUMP 1

*Neck jets
operate in
all zones.

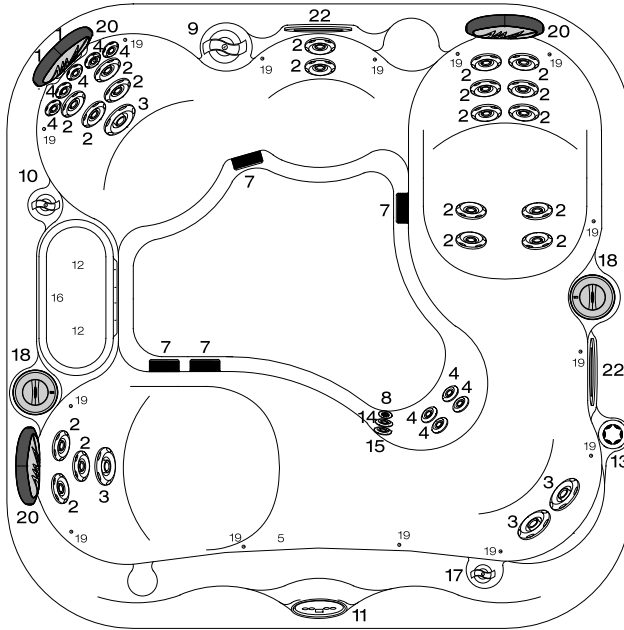

#	Component Identification	Qty.
1	HK™8 Neck Jets	2
2	HK™12 Jets	19
3	HK™16 Jets	4
4	HK™40 Jets	9
5	Light (option)	1
7	Suction Fittings	4
8	Floor Drain	1
9	Jet Selector	1
10	Neck Jet Valve	1
11	Bather's Control Panel	1
12	Filter Canisters	2
13	Spa Frog® (option)	1
14	Spa Frog® Return Fitting (option)	1
15	Ozone Injector Fitting	1
16	Waterfall Feature (option)	1
17	Waterfall Valve (option)	1
18	Adagio™ Speakers (option)	2
19	Constellation™ (option)	17
20	Cushioned Headrests (option)	3
22	Water Feature (option)	1
Physical Specifications		Size
Dimensions		84" x 84"
Height		35"
Corner Radius		17"
Seating Capacity/Positions		5/5
Weight Dry/Lbs.		780
Weight Full/Lbs.		3699
Water Capacity/Gallons		350
Total Therapy Jets		34



RESORT™ THERAPY CONTROL

ZONE 1
JETS 1
Upper,
mid-, lower-
back jets.*

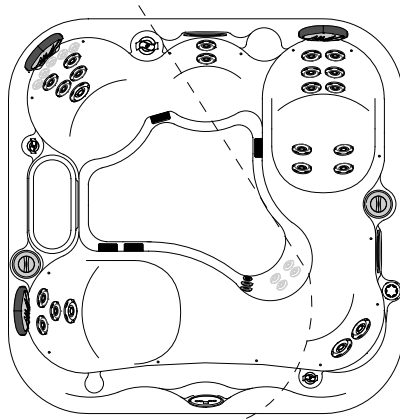

PUMP 1 **PUMP 2**

ZONE 1
JETS 2
Upper,
mid-, lower-
back jets.*

ZONE 2
JETS 1
Upper-
back jets.*

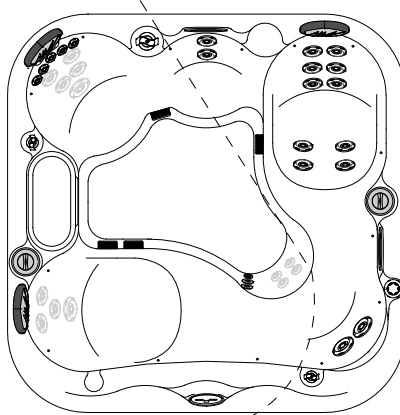

PUMP 1 **PUMP 2**

ZONE 3
JETS 1
Lower-
body jets.*

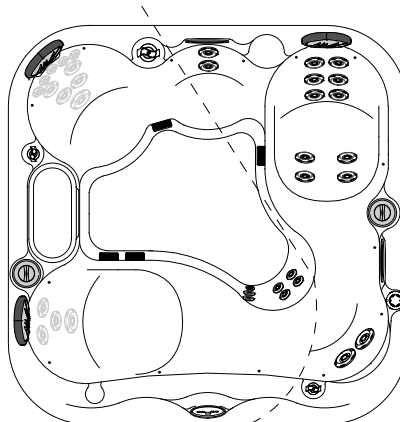

PUMP 1 **PUMP 2**

*Neck jets
operate in
zone 2.

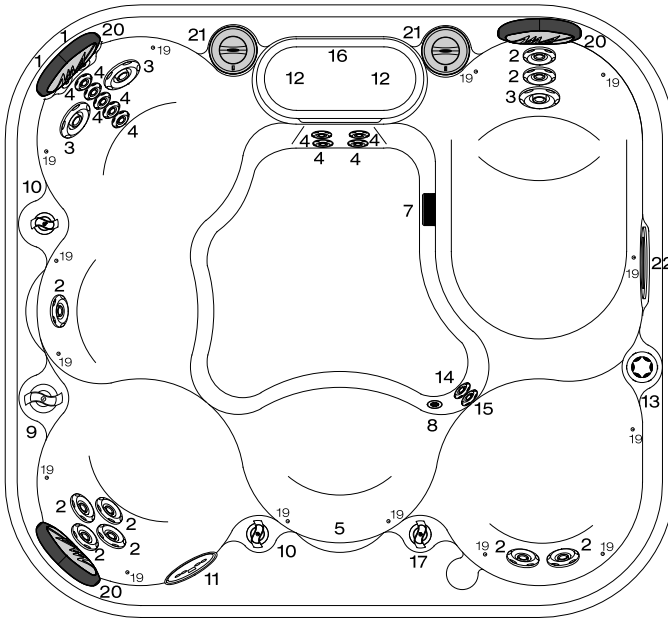

#	Component Identification	Qty.
1	HK™8 Neck Jets	2
2	HK™12 Jets	9
3	HK™16 Jets	3
4	HK™40 Jets	9
5	Light (option)	1
7	Suction Fittings	1
8	Floor Drain	1
9	Tri-Zone Control	1
10	Neck Jet Valve	1
11	Bather's Control Panel	1
12	Filter Canisters	2
13	Spa Frog® (option)	1
14	Spa Frog® Return Fitting (option)	1
15	Ozone Injector Fitting	1
16	Waterfall Feature (option)	1
17	Waterfall Valve (option)	1
19	Constellation™ (option)	17
20	Cushioned Headrests (option)	3
21	Adagio™ Speakers (option)	2
22	Water Feature (option)	1
Physical Specifications		Size
Dimensions		77" x 84"
Height		34"
Corner Radius		17"
Seating Capacity/Positions		5/6
Weight Dry/Lbs.		600
Weight Full/Lbs.		3436
Water Capacity/Gallons		340
Total Therapy Jets		23

QUEST™ THERAPY CONTROL

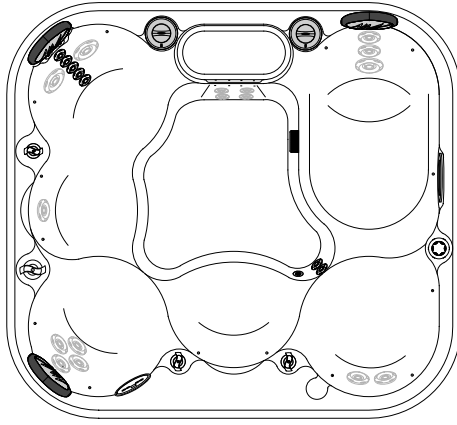

ZONE 1
Upper-,
mid- and
lower-back
jets.*

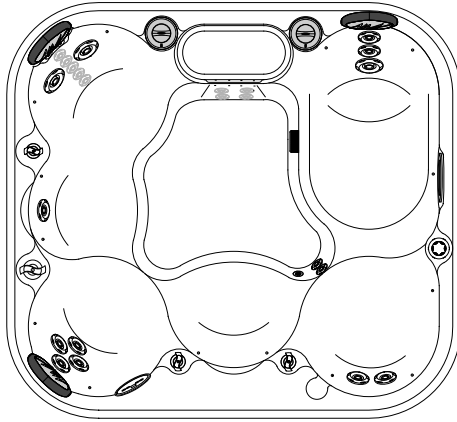

ZONE 2
Upper-,
mid- and
lower-back
jets.*

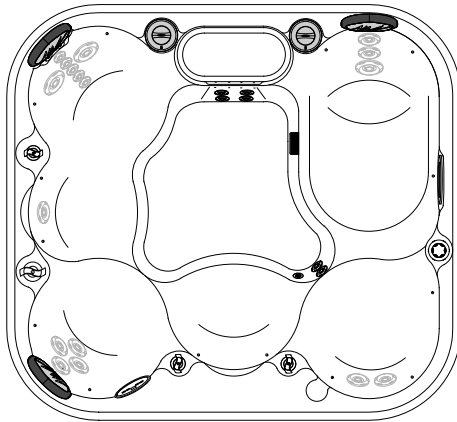

ZONE 3
Lower-
body jets.*

*Neck jets
operate in
every zone.

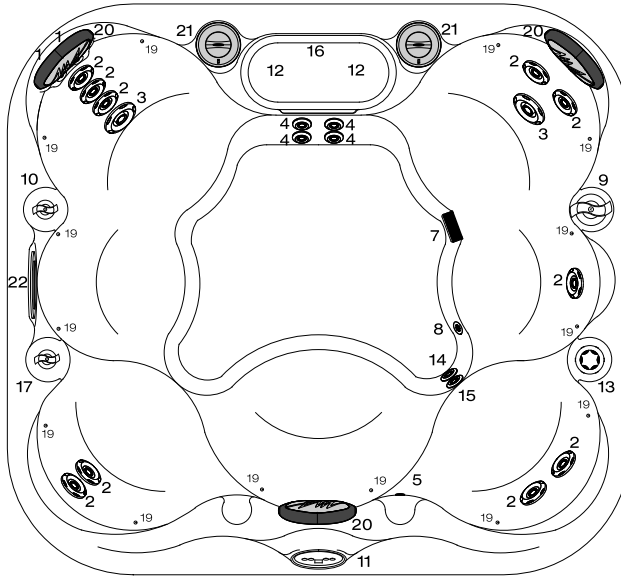

#	Component Identification	Qty.
1	HK™8 Neck Jets	2
2	HK™12 Jets	10
3	HK™16 Jets	2
4	HK™40 Jets	4
5	Light (option)	1
7	Suction Fittings	1
8	Floor Drain	1
9	Jet Selector	1
10	Neck Jet Valve	1
11	Bather's Control Panel	1
12	Filter Canisters	2
13	Spa Frog® (option)	1
14	Spa Frog® Return Fitting (option)	1
15	Ozone Injector Fitting	1
16	Waterfall Feature (option)	1
17	Waterfall Valve (option)	1
19	Constellation™ (option)	17
20	Cushioned Headrests (option)	3
21	Adagio™ Speakers (option)	2
22	Water Feature (option)	1
Physical Specifications		Size
Dimensions		77" x 84"
Height		34"
Corner Radius		17"
Seating Capacity/Positions		4/6
Weight Dry/Lbs.		600
Weight Full/Lbs.		3436
Water Capacity/Gallons		340
Total Therapy Jets		18

PROMISE™ THERAPY CONTROL

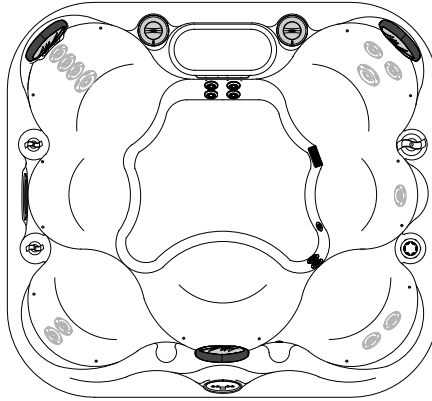

ZONE 1
Lower-
body jets.*

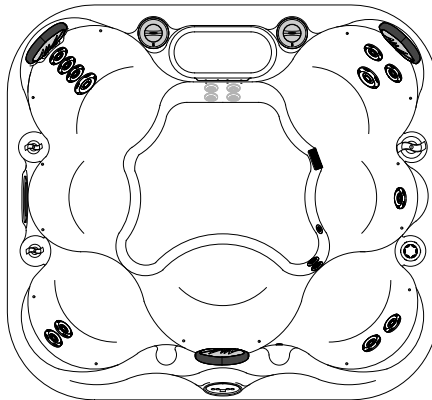

ZONE 2
Upper-,
mid- and
lower-back
jets.*

*Neck jets
operate in
all zones.

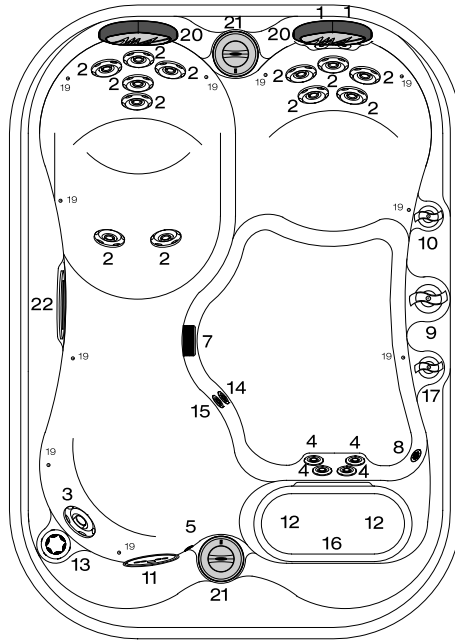

#	Component Identification	Qty.
1	HK™8 Neck Jets	2
2	HK™12 Jets	12
3	HK™16 Jets	1
4	HK™40 Jets	4
5	Light (option)	1
7	Suction Fitting	1
8	Floor Drain	1
9	Jet Selector	1
10	Neck Jet Valve	1
11	Bather's Control Panel	1
12	Filter Canisters	2
13	Spa Frog® (option)	1
14	Spa Frog® Return Fitting (option)	1
15	Ozone Injector Fitting	1
16	Waterfall Feature (option)	1
17	Waterfall Valve (option)	1
19	Constellation™ (option)	12
20	Cushioned Headrests (option)	2
21	Adagio™ Speakers (option)	2
22	Water Feature (option)	1
Physical Specifications		Size
Dimensions		84" x 60"
Height		29.5"
Corner Radius		17"
Seating Capacity/Positions		2/3
Weight Dry/Lbs.		410
Weight Full/Lbs.		1786
Water Capacity/Gallons		165
Total Therapy Jets		19

SPIRIT™ THERAPY CONTROL

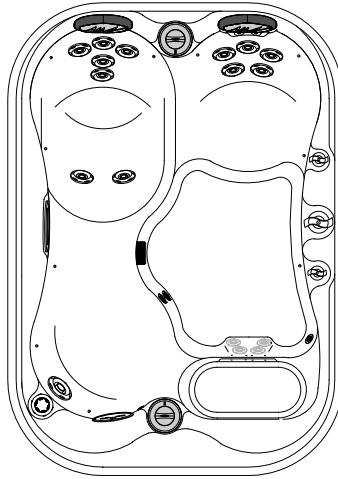

ZONE 1A
Upper- and
mid- and
lower-back
jets.*

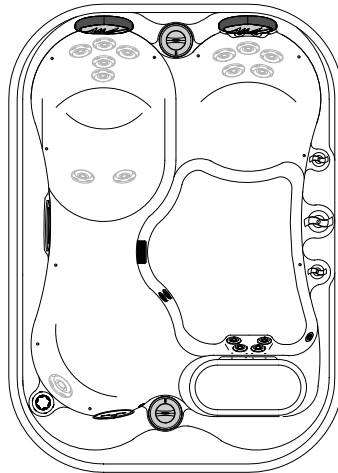

ZONE 1B
Lower-
body jets.*

*Neck jets
operate in
all zones.

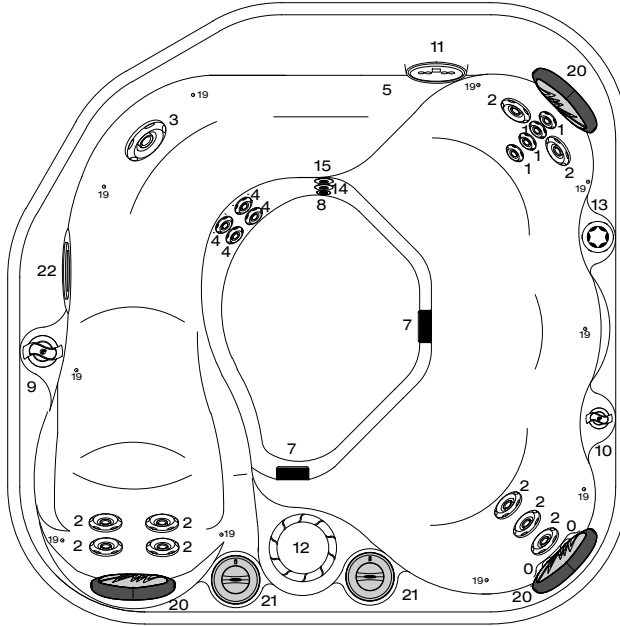

#	Component Identification	Qty.
0	HK™8 Neck Jets	2
1	HK™8 Jets	4
2	HK™12 Jets	9
3	HK™16 Jets	1
4	HK™40 Jets	4
5	Light (option)	1
7	Suction Fittings	2
8	Floor Drain	1
9	Jet Selector	1
10	Neck Jet Valve	1
11	Bather's Control Panel	1
12	Filter Canisters	1
13	Spa Frog® (option)	1
14	Spa Frog® Return Fitting (option)	1
15	Ozone Injector Fitting	1
16	Waterfall Feature (option)	1
19	Constellation™ (option)	13
20	Cushioned Headrests (option)	3
21	Adagio™ Speakers (option)	2
22	Water Feature (option)	1
Physical Specifications		Size
Dimensions		77" x 77"
Height		34"
Corner Radius		17"
Seating Capacity/Positions		4/5
Weight Dry/Lbs.		450
Weight Full/Lbs.		2660
Water Capacity/Gallons		265
Total Therapy Jets		20

MIRAGE™ THERAPY CONTROL

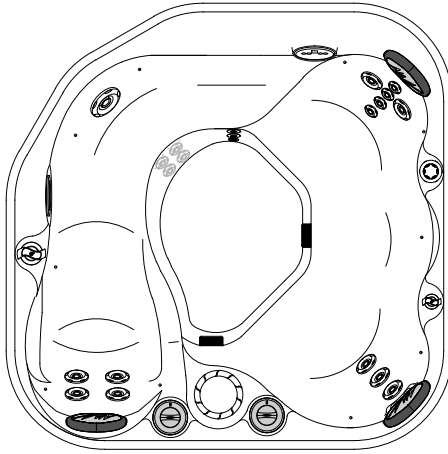

ZONE 1A
Upper- and
mid- and
lower-back
jets.*

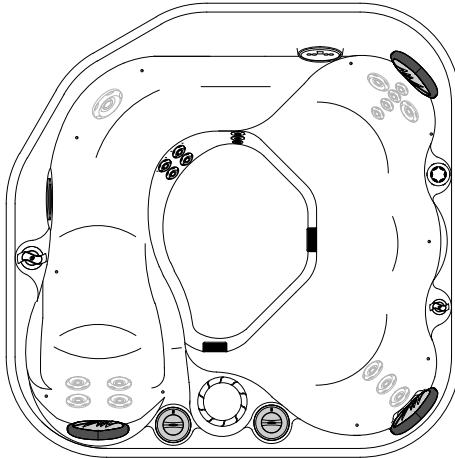

ZONE 1B
Lower-
body jets.*

*Neck jets
operate in
all zones.

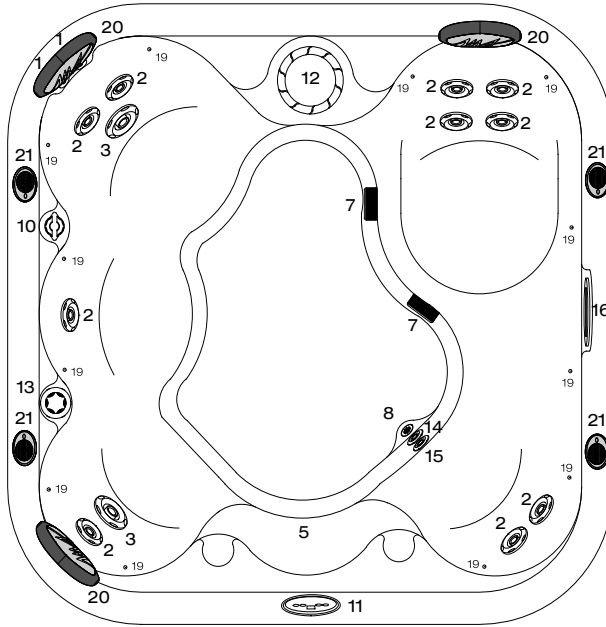

#	Component Identification	Qty.
1	HK™8 Neck Jets	2
2	HK™12 Jets	10
3	HK™16 Jets	2
5	Light (option)	1
7	Suction Fittings	2
8	Floor Drain	1
10	Neck Jet Valve	1
11	Bather's Control Panel	1
12	Filter Canister	1
13	Spa Frog® (option)	1
14	Spa Frog® Return Fitting (option)	1
15	Ozone Injector Fitting	1
16	Water Feature (option)	1
19	Constellation™ (option)	15
20	Cushioned Headrests (option)	3
21	Adagio™ Speakers (option)	4
Physical Specifications		Size
Dimensions		77" x 77"
Height		29.5"
Interior Depth		28"
Seating Capacity/Positions		4/5
Weight Dry/Lbs.		475
Weight Full/Lbs.		2977
Water Capacity/Gallons		300
Total Therapy Jets		14

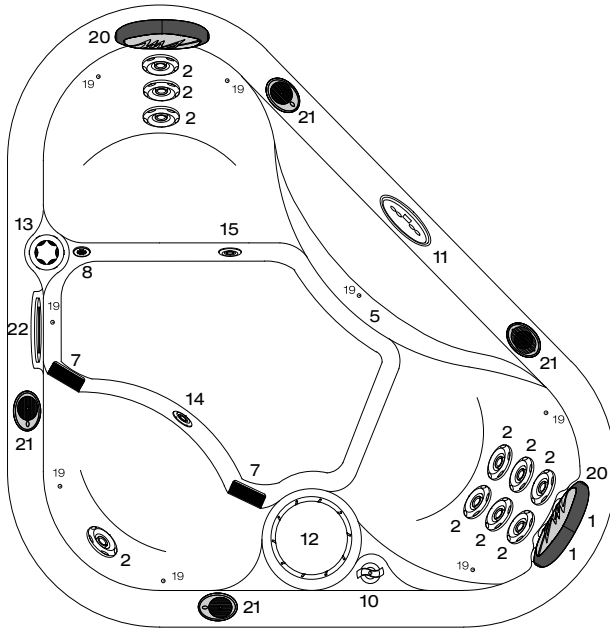

#	Component Identification	Qty.
1	HK™8 Neck Jets	2
2	HK™12 Jets	10
5	Light (option)	1
7	Suction Fittings	2
8	Floor Drain	1
10	Neck Jet Valve	1
11	Bather's Control Panel	1
12	Filter Canister	1
13	Spa Frog® (option)	1
14	Spa Frog® Return Fitting (option)	1
15	Ozone Injector Fitting	1
19	Constellation™ (option)	10
20	Cushioned Headrests (option)	2
21	Adagio™ Speakers (option)	4
22	Water Feature (option)	1
Physical Specifications		Size
Dimensions		68" x 68"
Height		29.5"
Corner Radius		17"
Seating Capacity/Positions		2/3
Weight Dry/Lbs.		300
Weight Full/Lbs.		1545
Water Capacity/Gallons		150
Total Therapy Jets		12

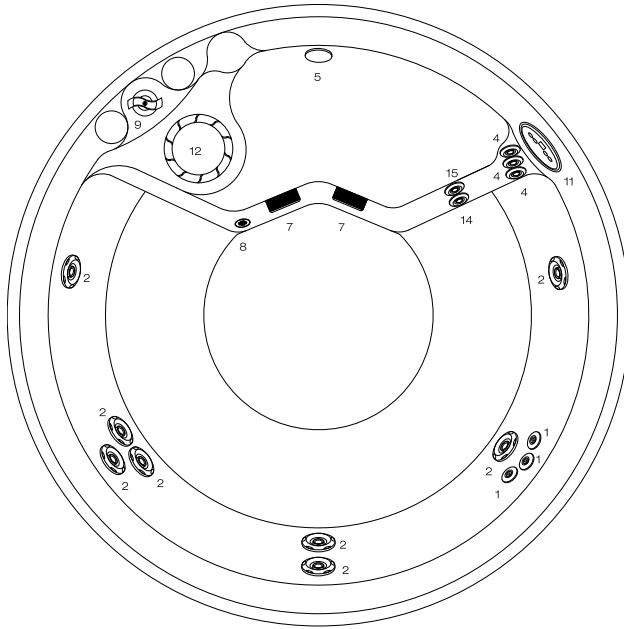

#	Component Identification	Qty.
1	HK™8 Jets	3
2	HK™12 Jets	8
4	HK™40 Jets	3
5	Light (option)	1
7	Suction Fittings	2
8	Floor Drain	1
9	Jet Selector	1
11	Bather's Control Panel	1
12	Filter Canister	1
15	Ozone-ready Injector Fitting	1
Physical Specifications		Size
Dimensions		76" diameter
Height		35"
Seating Capacity/Positions		4/5
Weight Dry/Lbs.		550
Weight Full/Lbs.		2635
Water Capacity/Gallons		250
Total Therapy Jets		14

ATTENTION: If you have problems priming the pump use the black thumbscrew in the upper corner of the door area to relieve the air lock to the pump. Use this solution as you are filling the spa or if the pump is running but no water is coming out of the jets. Please refer to start up instructions in the Owner's Manual.

1. Make sure the spa power is off.
2. Remove the door.
3. Remove the thumbscrew while filling the spa. (If spa is full remove the thumbscrew and let all air purge.)
4. Once air is purged replace the thumbscrew.
5. Power up the spa.
6. Make sure there are no leaks at the thumbscrew. Replace the door.



Destiny, Envy, Euphoria, Mirage, Promise, Quest, Rendezvous, Resort, Reward, Spirit

PUMP PRIMING (Pr)



Pump priming feature begins at startup. When your spa is energized, the LCD window displays a “Pr” message. This mode lasts approximately four to five minutes, if not exited manually by pressing the TEMP+/- pad.

On one-pump models: If you have problems priming the pump use the thumbscrew to relieve the air lock to the pump. Use this solution as you are filling the spa or if the pump is running but no water is coming out of the jets. See Equipment Diagram for more information.



UNDERWATER AND ENTRYWAY LIGHTS

Press the LIGHT pad on bather’s panel or remote control (option) to turn the underwater and Entryway lights on and off. The low-voltage system produces a night light for evening use. After being on for 60 minutes, the lights automatically turn off.

AQUA AMBIANCE™ AND CONSTELLATION™

Use SPA LIGHT pad. Step one: turn on light. Step two: turn off and then on within 2-3 seconds.

NOTE: LED lights and non-LED lights do not qualify for labor coverage. These parts can be purchased or exchanged under warranty at your authorized Marquis Spas® dealer.

WATERFALL FEATURE (OPTION)

The Waterfall feature and convenience tray attaches securely to the dual Vortex skimmer tops. **NOTE:** Don’t remove the waterfall top while the pumps are running.



JETS

Use the JETS pad on the bather panel or remote control. First press of the JETS pad activates pump on low-speed (and starts soak timer). Second press of the JETS pad activates pump on high-speed. Third press of the JETS pad turns jets off for all-quiet mode. Fourth press of

the JETS pad turns pump back to low-speed. If the pump is already on low (heating, filter cycle) then the first press starts the soak timer. After running on low- or high-speed for 15 minutes, the pump automatically turns off (unless in heating or filtering cycle).



SOAK TIMER

The soak timer starts the first time you press a JETS pad. The LCD window displays the elapsed time (1-30) for 55 seconds then switches to the current water temperature for five seconds then back to the timer. It continues to alternate for the entire 30 minutes. The timer runs for 30 minutes regardless of other functions in use (jets, temperature, or light). You can manually cancel the timer by pressing the TEMP+- pad and then the LIGHT pad.

REMOTE CONTROL (OPTION)

NOTE: During times of inactivity, wireless remotes should always be stored in the cup holder on the lip of the spa or removed from the spa. By storing the wireless remote out of water, it will be less susceptible to water intrusion, a situation that can occur after extended water exposure. More often, water intrusion occurs when spa owners attempt to replace the batteries in their remote and then do not properly reseal the remote. Battery replacement should only be performed by spa care professionals. Batteries and water intrusion into remote controls is not covered under the warranty. Remote controls do not qualify for labor coverage. These parts can be purchased or exchanged under warranty at your authorized Marquis Spas® dealer.



REMOTE CONTROL

CONSTANTCLEAN™ WATER MANAGEMENT WITH BUILT-IN SANITATION SYSTEM

(See Built-in Sanitation System)

Factory Default Settings:

- Filter Cycle Duration: F2 (2 hours)
- Filter Cycles: 2C (twice per day)
- Smart Logic: 1H (1 hour)

These settings represent the most commonly used settings, but your use may be different, depending upon many variables – frequency, number of bathers, duration, water capacity, etc. These variables affect the quality of water and the way it should be managed to achieve the most effective cleansing. Selectable choices for the settings of the operation systems allows flexibility and ensures your Marquis spa remains easy to maintain for your particular set of circumstances.



Marquis Ozonator reduces the need for chemical sanitizers.

SOLID-STATE OZONATOR (OPTION)

The ozone generator functions whenever the system is running on filter or clean up cycles.

CAUTION: Do not block ozone injector fitting (see spa diagrams). Blockage or partial blockage could result in back pressure that could flood the ozonator and result in failure.

SMARTCLEAN™ FILTRATION

Your spa is preset at the factory with a default setting to filter itself using the jet pump on low-speed for two hours twice in a 24 hour period. These settings represent the filter settings necessary for average use. The timing of the first filter cycle is determined by when the spa was initially energized. The first cycle begins six minutes after this initial power-up. The second filter cycle begins 12 hours after the first cycle.

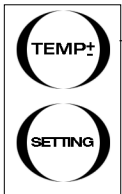
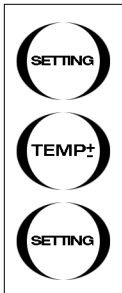

To adjust the filter settings

Press the SETTING pad to display the filter time settings (F1, F2, F4, F6). Use the TEMP+- pad to scroll through the options. When desired selection has been reached, press the SETTING pad again to enter selection and advance to the filter cycle settings (2C, 1d, 1n). For example, if you select 2C and F2, your spa will filter two hours twice a day for a total of four hours of filtration daily. Use the TEMP+- pad to scroll through filter cycle options. When desired selection has been reached, press the SETTING pad to enter selection and advance to the smart logic settings.

Selectable filter cycles and cycle duration

- 2C: twice per day (once every 12 hours)
- 1d: once during the day
- 1n: once during the night
- F1: 45 minutes
- F2: 2 hours
- F4: 4 hours
- F6: 6 hours

SMARTCLEAN™

Your spa is preset at the factory with a default setting to filter for one hour (1H) every time your spa is used. This SmartClean™ filtration cycle begins 30 minutes after the spa light or jet pump has been deactivated. The pump runs on low-speed to filter the water for the cycle's duration.

Selectable SmartClean™ Settings

- 1H: 1 hour
- 2H: 2 hours
- 3H: 3 hours
- 4H: 4 hours
- OH: Off

To adjust the SmartClean™ settings:

Use the TEMP+/- pad to scroll through options. When desired selection has been reached. Press SETTING pad to enter selection and exit settings mode.

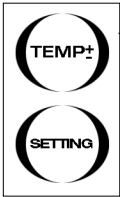

TEMPERATURE DISPLAY AND ADJUSTMENT

Factory Default Settings:

- Temperature: 100°F (38°C)

The LCD window displays the actual water temperature. Pressing the TEMP+/- pad makes the numbers flash, then pressing the pad again (repeatedly) increases the set temperature one degree at a time, up to 104°F (40°C). After a short pause, the actual temperature displays. Press TEMP+/- pad repeatedly to decrease the set temperature to 80°F (27°C).



HEAT LIGHT

The HEAT light illuminates when the heater is on. The pump circulates on low-speed whenever the thermostat calls for heat.

HEAT MODE

Your spa comes preset in the standard heat mode. The heat mode can be adjusted to one of three different settings:

Standard Mode (St)

The spa water heats to the temperature as set at the bather's panel. In this mode the filtration pump turns on for two minutes every half-hour to "poll" or check the water. If heat is needed the unit heats to the set temperature. The LCD window steadily displays the actual temperature in this mode.

Economy Mode (Ec)

In this mode the spa only heats to the set temperature during a filter cycle. The LCD window displays "Ec" alternately flashing with the actual temperature when the spa is up to temperature and "Ec" steadily when the spa's water temperature is below the set temperature.

Sleep Mode (SL)

Your spa will maintain a water temperature that is 20°F (7°C) below the set temperature. The heater functions only during a filter cycle. The LCD window displays “SL” flashing alternately with the actual temperature when the spa is up to set temperature and displays “SL” steadily when below set temperature.

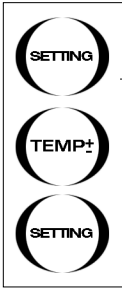

To Adjust the Heat Mode:

First press the SETTING pad to display the heat mode settings (St, Ec, SL). Use the TEMP+- pad to scroll through the options. When desired selection has been reached, press SETTING pad again to enter selection and advance to the filter cycle settings (F1, F2, F4, F6).

Maintenance Reminders

- **CL:** Clean Filter LED will illuminate every 30 days.
- **CH:** Change Water LED will illuminate every 90 days. To reset maintenance reminders, press SETTINGS pad.

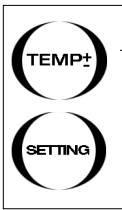

SYSTEM LOCK

Once you find and establish the settings that work best for your individual needs, use system lock to keep from inadvertently changing the settings.

Press the TEMP+- pad and then immediately press the SETTING pad. Unlock by repeating sequence. While the system is locked, you may still operate the jets and light. The LCD window displays LC to indicate the system is locked when you try to change the temperature or settings.

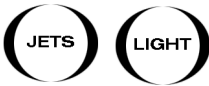

REMOTE CONTROLS (OPTION)

(See SPA CONTROL OPERATION, Jets)



EPIC 9-BUTTON PANEL



SHOW 10-BUTTON PANEL

EPIC & SHOW CONTROLS



PUMP PRIMING (Pr)

Pump priming feature begins at startup. When your spa is energized, the LCD window displays a “Pr” message. This mode lasts approximately four to five minutes, if not exited manually by pressing the TEMP+ pad.



UNDERWATER AQUA AMBIANCE™, ENTRY-WAY LED LIGHTS AND CONSTELLATION™

Press the LIGHTS pad on the bather’s panel or remote control (option) to turn the lights on and off. The icon appears in the lower center of the display when the light is on. For Constellation, press LIGHTS pad to turn on step one color. To change colors, press LIGHTS pad again to turn off for one second. Then press LIGHTS pad again for step two color. Repeat for all color options. After being on for 60 minutes, the lights automatically turn off. (See SETTINGS for automatic light programming.)



TRAY FEATURE

The Epic’s Waterfall feature and convenience tray attaches securely to the dual Vortex skimmer tops. **NOTE:** Don’t remove the waterfall top while the pumps are running. The tray feature on the Show attaches to the spa interior.



SOAK TIMER

The soak timer starts the first time you press the TIMER pad. The LCD window displays “E” for the elapsed time followed by time in minutes (“00, 01, 02”, etc.). A second press of the TIMER pad will exit the timer mode. The timer display and the current temperature display will alternate every 10 seconds.

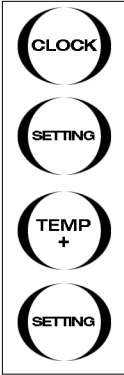

SETTINGS

Clock

Press the CLOCK pad followed by the SETTING pad. "Program" will be shown in the upper left corner of the panel display and the hour will begin flashing. To adjust, press the TEMP+ or TEMP- pad. Once the correct hour has been set, press SETTING pad to set the minutes. "Minutes" will flash. Follow above procedure to set the correct minutes.

Filter Cycle 1:

Press the CLOCK pad followed by the SETTING pad three times to enter Filter 1 programming. "Program filter 1 start time" will be shown in the upper left corner of the panel display and the hour will begin flashing. To adjust, press the TEMP+ or TEMP- pads. Once the correct hour has been set, press SETTING pad to set the minutes. Follow above procedure to set the correct minutes. Press the SETTING pad again and "Program filter 1 end time" will be shown in the upper left corner of the panel display and the hour will begin flashing. Follow above procedures to set the correct hour and minutes.

NOTE: When in a filter cycle the Filter Cycle LED will illuminate.

Filter Cycle 2:

Press SETTING pad to enter filter 2 programming mode. "Program filter 2 start time" will be shown in the upper left hand corner of the panel display and the hour will begin flashing. Follow above procedure to set the correct hour and minutes. Press the SETTING pad again and "Program filter 2 end time" will be shown in the upper left corner of the panel display. Follow above procedure to set correct hour and minutes.

Spa Light:

Press SETTING pad to enter spa light programming mode. The light icon will begin flashing at the bottom of the panel display. "Start time" will be shown in the upper left hand corner of the panel display and the hour will begin flashing. Follow above procedure to set the correct hour and minutes. Press the SETTING pad again and "end time" will be shown in the upper left corner of the panel display and the hour will begin flashing. Follow above procedure to set the correct hour and minutes. Press the CLOCK pad to exit the programming mode.

NOTE: Any time during the setting of features you may exit the programming mode by pressing the CLOCK pad. If you do not want to run any of the filter modes or spa light cycles, set the start and end times for the same time.

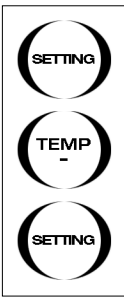

HEAT MODE

Your spa comes preset in the standard heat mode. Allow 12-24 hours for the heater to achieve your desired water temperature.

The heat mode can be adjusted to one of three different settings:

Standard Mode

The spa water heats as necessary to maintain the set temperature. "Standard" will display until the mode is changed. **NOTE:** The last measured temperature displayed is current only when Pump 1 has been running for at least two minutes.

Economy Mode

In this mode the spa only heats to the set temperature during a filter cycle. The "Economy" icon will display until the mode is changed. Press the JETS 1 pad to put the spa in "Standard-in-Economy" mode which operates the same as Standard mode (both Economy and Standard will display). The spa reverts to Economy mode automatically after one hour.



Sleep Mode

The spa water heats to within 20°F (7°C) of the set temperature only during filter cycles. "Sleep" will display until the mode is changed.

To Adjust Heat Mode

First press the SETTINGS pad. The current heat mode will start flashing. Use the TEMP- pad to scroll through the modes. When desired mode is displayed touch the SETTINGS pad again to lock the mode.

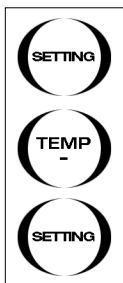

Panel Lock

Press TEMP+ or TEMP- pad followed by QUIET SOAK pad to lock. Then press TEMP+ or TEMP- pad followed by QUIET SOAK pad to unlock.

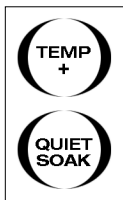

- Lock feature locks all user settings: time, filter cycles, heat modes, SmartClean™ and temperature settings.
- Lock feature does not lock Jets 1, Jets 2, Timer, Spa Light, Waterfall Light, Quiet Soak, or Clock.
- Secured LED will illuminate when system is locked.

CONSTANTCLEAN™ WATER MANAGEMENT WITH BUILT-IN SANITATION SYSTEM

(See Built-in Sanitation System)

Ozonator Operation

The ozone generator functions whenever pump 1 is on low-speed in Filter cycles and SmartClean™ cycles ONLY.

User Preference Settings

Suppress reminders: Displayed as (Sr.n) for no, and (Sr.Y) for yes. When set to (Sr.Y), reminders are never shown in the display. When set to (Sr.n), all reminders are shown.

Temperature display in Fahrenheit: Displayed as (tc.n) for no, and (tc.Y) for yes.

24 hour time: Displayed as (24.n) for no (12 hour AM/PM), and (24.Y) for yes (24 hour military).

SmartClean™ settings: Displayed as (cc.0) for SmartClean™ off, (cc.1) 1 hour, (cc.2) 2 hour, (cc.3) 3 hour, and (cc.4) for 4 hour Smart Logic durations. When the spa is in a SmartClean™ cycle, the SmartClean™ LED will illuminate.

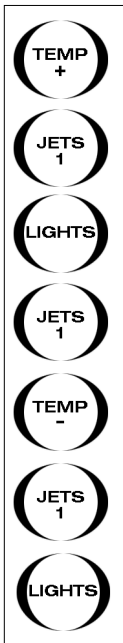
To Enter the User Preference Mode

- Press the TEMP+ pad
- Press the JETS 1 pad (displays (Edt))
- Press the LIGHTS pad (displays (USr))
- Press the JETS 1 pad (displays (Sr.n))
- Use TEMP + or TEMP- pad to scroll through options
 - Sr.n: Reminders not suppressed
 - tc.n: Temperature display not in Celsius
 - 24.n: 12 hour AM/PM
 - cc.1: One hour Smart Logic
- Once the desired selection has been reached press the JETS 1 pad. The last number or letter will flash. Use the TEMP + or TEMP- pad to change the setting. Press the JETS 1 pad to enter selection and return to previous mode.
- Press the LIGHTS pad twice to return to normal operation.
- At any point, if a pad is not pressed within thirty seconds of a previous pad press, the mode will cancel and the spa will return to normal operation.

To Change the Set Temperature

Factory default temperature setting: 100°F (38°C). The LCD window displays the actual water temperature. Press the TEMP+ or the TEMP- pad. Each pad press changes the set temperature by one degree. Temperature can be set between 80°F and 104°F (26°C and 40°C). When the spa is heating the Heat icon will be shown in the lower right corner of display.



Marquis Ozonator reduces the need for chemical sanitizers.



Quiet Soak

Press the QUIET SOAK pad to enter the soak mode. All automatic functions related to the pumps are disabled (i.e., filter cycles, SmartClean™ cycles). If either pump 1 or pump 2 are operating, they will be turned off. Soak mode lasts for 30 minutes, then the spa returns to normal operation. All button functions operate as normal while in a Soak mode. When in a Soak mode, the Soak LED will illuminate.

Maintenance Reminders

- rSA will be displayed in the LCD window every 21 days.
- Clean Filter LED will illuminate every 30 days. rCL will be displayed in the LCD window.
- Change Water LED will illuminate every 90 days. rCH will be displayed in the LCD window.
- rCA will be displayed in the LCD window every 90 days (see LCD Diagnostic Messages).
- To reset maintenance reminders, press SETTINGS pad. (See USER PREFERENCE SETTINGS to suppress maintenance reminders.)

JETS

Use JETS 1 pad on either bather’s panel or remote control. First press JETS 1 pad to activate pump on low-speed. Second press of JETS 1 pad activates pump on high-speed. Third press of JETS 1 pad turns jets off for all-quiet soak setting. Fourth press of JETS 1 pad returns pump to low-speed. Repeat above procedure for JETS 2 and JETS 3.

Pump 1, 2 and 3: Epic (2 pumps), Show (3 pumps)

- High-speed run time-out: 15 minutes
- Low-speed run time-out: 15 minutes (if not in filter cycle or SmartClean™).

REMOTE CONTROLS

(See OPERATING YOUR SPA, Light, and Jets.)

NOTE: During times of inactivity, wireless remotes should always be stored in the cup holder on the lip of the spa or removed from the spa. By storing the wireless remote out of water, the remote will be less susceptible to water intrusion, a situation that can occur after extended water exposure. More often, water intrusion occurs when spa owners attempt to replace the batteries in their remote and then do not properly reseal the remote. Battery replacement should only be performed by authorized Marquis Spas® dealer.



Spa Monitor In-house Remote

Epic and Show

See Spa Monitor manual for complete set up and operation instructions.

Remote Control Spa Functions

Remote Show operation

It is designed with sophisticated technology that will allow you to consolidate many of your existing remote controls along with the Adagio™ and Aquavision audio systems in your spa.

Before you can use your remote, you will need to program it to operate the specific home entertainment components you wish to control. Follow the instructions detailed in the remote manual to set up and enjoy your new remote control.

DVD Unit (option on Show)

Aquavision is a completely independent waterproof video monitor that is built to the latest regulations in waterproofing and safety, it is designed to integrate into your spa environment. Aquavision incorporates the latest state of the art screens with the latest and best features. Aquavision features heated screen areas to prevent the front from misting up in humid conditions or even freezing up in cold conditions. The E-Suite™ features an Aquavision unit with Adagio™ audio system and a wireless remote control.

Operating the Monitor



Gently push the button on top of the self-rising monitor unit to raise it. To lower the monitor unit gently push the button. Make sure monitor unit is in the down position before closing the spa cover. Monitor lift mechanism is manufacturer-warranted against failure to lift due to manufacturing defects only. Closing the spa cover with monitor in the up position or forcing the monitor down too rapidly can result in damage. Please refer to the Aquavision manufacturer's owner's manual for features, operation, and troubleshooting.

ADAGIO™ AUDIO SYSTEM

Adagio™ Stereo

Adagio is easy to operate with logical push button controls and function keys. Please refer to the Poly-Planar Marine Audio Center Manufacturer's owner's manual for features, operation, and troubleshooting.

NOTE: Avoid water splashing on the stereo face. Never insert a disk or operate the stereo with wet hands. Moisture can damage internal components. Water intrusion into stereo is not covered under warranty. See Poly-Planar owner's manual for coverage information. Consult your Marquis Soundsations™ Adagio™ Audio Systems Limited Warranty for more information about coverage.

Adagio™ Speakers

Gently push the top of the self-rising speakers to raise them. Hold the speaker top, avoiding the speaker screens, and gradually rotate the speakers as desired. To lower the speakers gently push the speaker top until it is completely closed. Make sure speakers are in the down position before closing the spa cover. Speaker lift mechanism is manufacturer-warranted against failure to lift due to manufacturing defects only. Closing the spa cover with speakers in the up position or forcing the speaker down too rapidly can result in damage.

- **CAUTION** - Risk of Electric Shock. Do not leave compartment door open.
- **CAUTION** - Risk of Electric Shock. Replace components only with identical components.
- Do not operate the audio controls while inside the spa.
- **WARNING** - Prevent Electrocution. Do not connect any auxiliary components (for example, cable, additional speakers, headphones, additional audio/video components, etc.) to the system, except as provided by the following: The 3.5 mm auxiliary jack is designed for input only from devices such as an MP3 player operating at 4.5 V or less.
- These units are not provided with an outdoor antennae; it should be installed in accordance with Article 810 of the National Electrical Code, ANSI/NFPA 70.
- Do not service this product yourself as opening or removing covers may expose you to dangerous voltage or other risk of injury. Refer all servicing to qualified service personnel.
- If the power supply connections or power supply cord(s) are damaged; if water is entering the audio compartment or any electrical equipment compartment area; if the protective shields or barriers are showing signs of deterioration; or if there are signs of other potential damage to the unit, turn off the unit and refer servicing to a qualified service personnel.
- This unit should be subjected to periodic routine maintenance (for example, once every three months) to make sure that the unit is operating properly.

Adagio™ Remote Control (option)

- With the speakers in the raised position, point the remote at the speakers.
- The remote controls the Adagio™ audio system as well as spa functions.
- Do not leave the remote in the spa.
- Epic and Show models: LIGHTS button controls the spa light; JET 1 button controls pump 1; JET 2 button controls pump 2; Show: JET 3 button controls pump 3.
- Euphoria, Resort and Reward models: The LIGHTS button controls the spa light; the JET 1 button controls pump 1 and 2.

Adagio™ Audio Expansion Port

The built-in audio expansion port allows you to connect optional accessories. Use the supplied 3.5 cm cord to attach MP3 player. **NOTE:** The 3.5 cm auxiliary jack is designed for input only from devices such as an MP3 player operating at 4.5V or less.

ENVY, MIRAGE, PROMISE, QUEST, SPIRIT, RENDEZVOUS, RETREAT

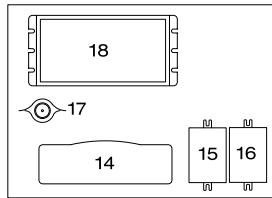
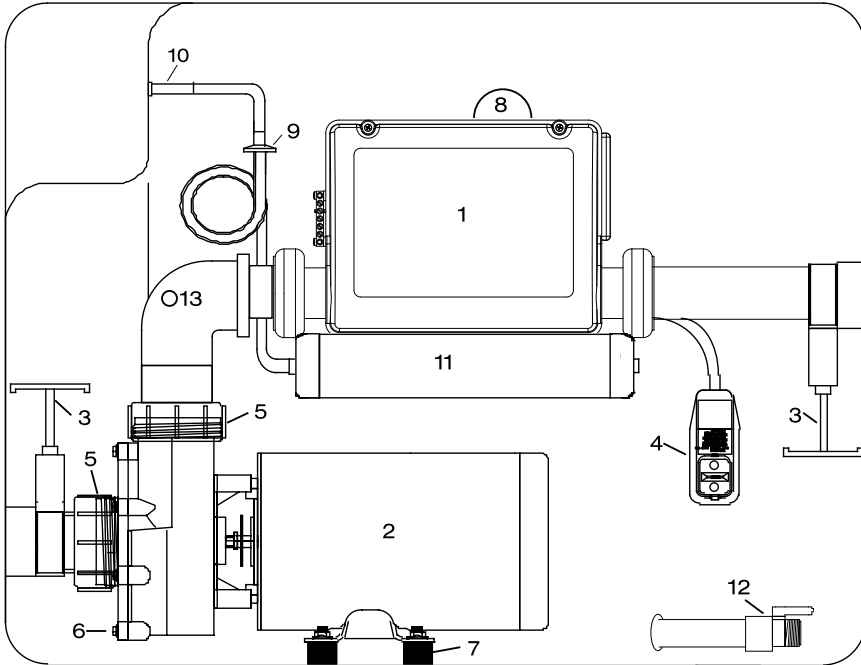

#	Component	Quantity
1	Control Box and Heater	1
2	Pump	1
3	Slice Valves	2
4	GFCI	1
5	Pump Unions	2
6	Pump Plug	1
7	Motor Mounts	4
8	Light	1
9	Check Valve (option)	1
10	Ozonator Fitting	1
11	Ozonator (option)	1
12	Drain Valve	1
13	Pump Thumbscrew	1
14	Adagio™ Stereo Head (option)	1
15	Cross Over Control (option)	1
16	Spa Control (option)	1
17	MP3 Auxiliary Jack (option)	1
18	Stereo Power Supply (option)	1

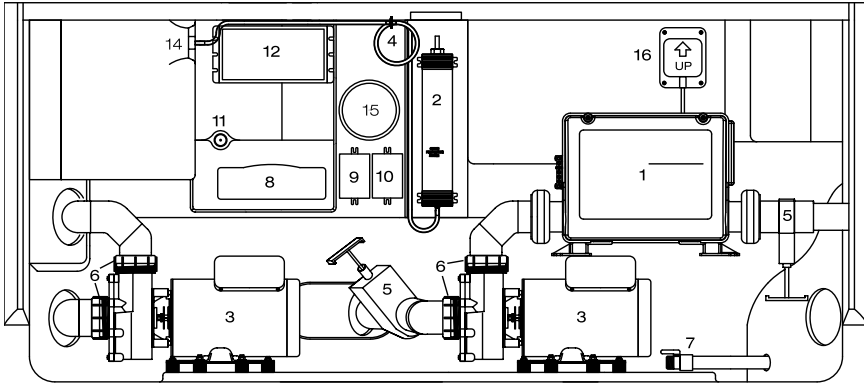
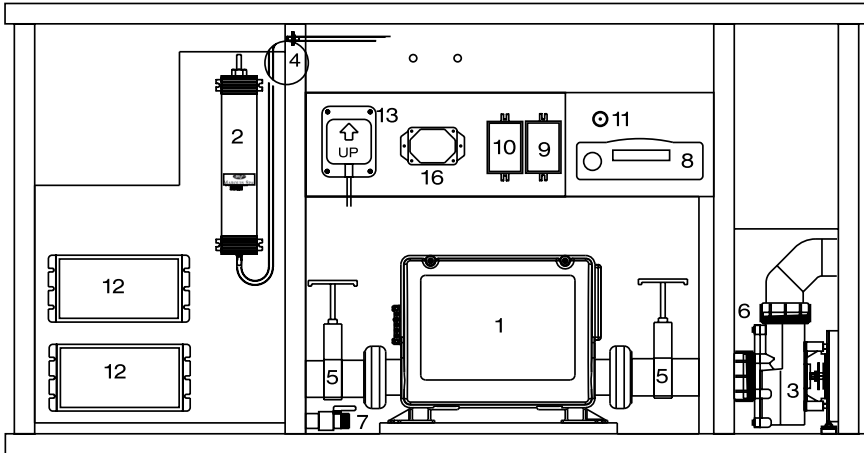
DESTINY, EUPHORIA, RESORT, REWARD AND EPIC

SHOW

#	Component	Quantity
1	Control Box and Heater	1
2	Ozonator (option)	1
3	Pumps*	2
4	Check Valve (option)	1
5	Slice Valves	2
6	Pump Unions	4
7	Drain Valve	1
8	Adagio™ Stereo Head (option)	1
9	Cross Over Control (option)	1
10	Spa Control (option)	1
11	MP3 Auxiliary Jack (option)	1
12	Stereo Power Supply (option)	1
13	Spa Monitor (option Epic & Show)	1
14	Ozonator Fitting	1
15	Light	1
16	Constellation™ LED Control (option)	1

*Show: for auxiliary pumps see Show SPA MODEL DIAGRAM



PLEASE NOTE: The following corrective actions may be performed by the spa owner. If the trouble cannot be corrected in the steps below, please contact your authorized Marquis Spas® dealer for service. (Improper servicing by an unauthorized service provider or spa owner could result in damage not covered by the warranty and could cause serious injury.)

EQUIPMENT WILL NOT OPERATE

- Check the control panel LCD window for diagnostic code.
- 240V Spas: Check the circuit breaker on the main circuit panel.
- 120V Spas: Check the GFCI power cord and reset if necessary (see **IMPORTANT SAFETY INSTRUCTIONS** at beginning of manual).
- Check the condition of the power cord.

INADEQUATE JET ACTION

- Be sure the shut-off valves are completely open.
- Open the jets by turning the jet face to allow for maximum water flow.
- Check that the air control valve is open (rotate lever counterclockwise).
- Check for obstruction or restrictions at suction guard(s) or filters, such as leaves, etc.

JET VALVES ARE HARD TO OPERATE

- Valves and rotating jets that become hard to turn is an indication of sand, dirt or too high calcium level in the water.
- Remove components and rinse before damage occurs.
- Advise bathers to shower or use a foot bath before entering the spa. Failure to use or maintain valves as directed may cause damage by introduction of foreign materials such as dirt, sand and calcium that is not covered under the warranty.

NO HEAT

- Check temperature displayed in the LCD window for desired temperature setting.
- Inspect the filter cartridge(s) for dirt and debris.
- Check that the water is at proper level, 2/3 up the Vortex skimmer opening(s).
- Check HEAT MODE to be certain spa is not in SLEEP MODE.
- Lower ambient temperatures may result in heat loss.

NOTE: Do not expect instant hot water from the jets. It will take the heater 12-24 hours to heat the water to the temperature you desire.

LIGHT DOES NOT WORK

- Press the LIGHT pad on the control panel.
- Reposition the light bulb in the socket. (See REPLACING LIGHT BULB.)
- Replace the light bulb with a 6 WATT BULB (GE 918 ONLY).

OZONATOR BUILDUP

There can be a build up of nitrous compounds that typically gathers at the ozone outlet connection to the tubing after a six to 12 month period. If you see a "gummy" build up at the point where the ozone tubing is connected to the ozone generator, do the following:

- Turn electrical power off.
- Disconnect the tubing and clean it out using a Q-tip dipped in white vinegar. Take care to avoid cracking or breakage when you remove the tubing from the barbed fitting.

LCD DIAGNOSTIC MESSAGES

The advanced technology built into the spa allows it to perform a number of self-diagnostic system checks and it can display a variety of messages in the LCD window on the control panel.

OHH and HH:

Over heat protection. If a malfunction occurs and the spa water reaches 112°F (44°C), the system completely shuts down. In such a condition, **DO NOT ENTER THE WATER**. Turn off all power to the spa. Remove spa cover and allow water to cool. Once the heater has cooled, turn on power to the spa, then reset by pushing any pad. If spa does not reset, shut off the power to the spa and contact your authorized Marquis Spas® dealer for service. Several conditions could lead to overheating, for example, low water level, shut-off valves closed while heater is on, dirty filter, and restriction in the plumbing lines. After the power is turned back on, the spa will not restart itself until the water temperature within the spa drops to a lower, predetermined temperature.

OHS and OH:

Over heat protection. The spa has shut down. One of the sensors has detected that the spa water is 110°F (43.3°C). **DO NOT ENTER THE WATER**. Turn off all power to the spa. Remove spa cover and allow water to cool. Once the heater has cooled, turn on power to spa, then reset by pushing any pad. If spa does not reset, shut off the power to the spa and contact authorized Marquis Spas® dealer for service.

ICE and IC:

Freeze protection has been activated. Contact your authorized Marquis Spas® dealer for service.

SnA and SA:

A sensor that is plugged into the Sensor "A" jack is not working. The spa turns off. Contact your authorized Marquis Spas® dealer for service.

Snb and SB:

A sensor that is plugged into the Sensor "B" jack is not working. The spa turns off. Contact your authorized Marquis Spas® dealer for service.

SnS and SN:

Sensors are out of balance. If this is alternating with the temperature, it may just be a temporary condition. If the display shows only this message (periodically blinking), the spa is shut down. Contact your authorized Marquis Spas® dealer for service.

NOTE: If power is shut off or a power outage occurs the 240V system has a battery backup. All user settings are retained.

HFL and HL:

A substantial difference between the temperature sensors was detected. This could indicate a flow problem. Check water level in spa. Refill if necessary. If the water level is okay, make sure the pumps have been primed. If problem persists, contact your authorized Marquis Spas® dealer for service.

NOTE: Spas can experience an overheat failure when in Economy or Sleep modes if equipment is in direct sunlight. To resolve this problem change to Standard mode setting.

LF:

Persistent low flow problems. (Displays on the fifth occurrence of the HFL message within 24 hours.) Heater is shut down, but other spa functions continue to run normally. Follow action required for HFL message. Heating capacity of the spa will not reset automatically. You may press any pad to reset.

dr:

Inadequate water detected in heater. Check water level in spa. Refill if necessary. If the water level is okay, make sure the pumps have been primed. Press any pad to reset

drY:

Inadequate water detected in heater. (Displays on third occurrence of dr message.) Spa is shut down. Follow action required for “dr” message. Spa will not automatically reset; you may press any pad to reset.

Pr:

When your spa is first energized, it will go into Priming mode. It will last for up to four or five minutes and then the spa will begin to heat and maintain the water temperature in the Standard mode.

-- F; -- C:

Temperature unknown. After the pump has been running for two minutes, the temperature will display.

-- -:

The temperature is not current. The spa is in Economy or Sleep mode. The pump may have been off for hours. If you wish to see the current spa temperature, either switch to Standard mode or turn Jets 1 on for at least two minutes.

SbY:

Standby mode has been activated by pressing a pad combination on the user panel. Press any pad to leave Standby Mode and return to normal operation.

Additional Diagnostics for Epic and Show models:

rtC: Hardware failure. Contact dealer.

PSt: Hardware failure. Contact dealer.

CrC: Firmware install problem. Contact dealer.

CFE: Configuration error, spa cannot start up. Contact dealer.

GFI: Spa could not trip GFCI. Contact dealer, continued operation could be unsafe.

StU: A pump appears to be stuck on, causing the water temperature to creep up, possibly to hazardous levels. **POWER DOWN SPA IMMEDIATELY. DO NOT ENTER THE WATER.** Contact dealer.

Hot: A pump appears to have been stuck on the last time spa was powered. **POWER DOWN SPA IMMEDIATELY. DO NOT ENTER THE WATER.** Contact dealer.

NOTE: If power is shut off or a power outage occurs the 240V system has a battery backup. All user settings are retained.



MAINTENANCE REMINDERS

The following reminders will be shown on the LED lights indicating it is time for maintenance. Reminder messages will also be displayed in the LCD window. Reset the reminders by pressing the TEMP+, TEMP-, or SETTINGS pad. Press any pad to reset maintenance reminders on four-button panels.

rSA:

Check Bromine:

rSA will be displayed in the LCD window every 21 days.

rCL:

Clean Filter:

LED will illuminate every 30 days.

rCL will be displayed in the LCD window.

rCH:

Change Water:

LED will illuminate every 90 days.

rCH will be displayed in the LCD window.

rCA:

Change Minerals:

rCA will be displayed in the LCD window every 90 days.

CH:

Change Water

CL:

Clean Filter

IMPORTANT CHEMICAL SAFETY PROCEDURES

1. Always keep chemicals out of reach of children.
2. Read product labels carefully prior to use.
3. When dissolving, always add chemicals to water, do not add water to chemicals. Some dry chemicals should be dissolved prior to adding them to the spa. Using a clean container, dip some water from the spa. Mix until dissolved, then add to circulating water.
4. CAUTION: Do not mix chemicals together. Add them separately to the spa water.
5. All chemical products should be stored in a cool, dry, well-ventilated area where the average temperature does not exceed 90°F (32°C). Keep storage area clean of debris such as rags, newspaper, and combustible materials.
6. Keep chemicals away from open flame or other heat source. Do not smoke near chemicals. If a dry chlorine chemical fire should occur, use water only. Do not use a dry chemical fire extinguisher to attempt to put out the fire.
7. When adding chemicals, always keep the water circulating in the spa with jets in a downward circular pattern for better chemical distribution. Add chemicals to the spa water one at a time. Allow several minutes between any new chemical additions using the jet action to evenly distribute throughout the spa.
8. It is important to leave the spa cover open for 20-30 minutes while shock treating your spa to avoid damage. Do not leave spa unattended while cover is open. Damage such as discoloration or brittle vinyl due to chemical damage is not covered under the warranty.
9. After adding chemicals, wait the amount of time recommended on the chemical container before retesting your water for an accurate reading. Retest your spa water before using.
10. If you have any questions or concerns about the correct procedures for handling chemicals, please contact your authorized Marquis Spas® dealer.

WATER CARE

There are three things necessary for clean safe water:

1. CIRCULATE: Water has to be circulated regularly; it can not be stagnant.
2. FILTER: Water has to be filtered to remove particulate and debris.
3. SANITIZE: Water has to be sanitized to kill organisms like algae, bacteria and virus.

It is critical to maintain proper water balance to protect the spa heater and other components from damage. Damage to the spa surface and equipment caused by poor chemical or harsh chemical treatment is not covered under the warranty. Discoloration of jet faces, valves and controls are an indication of poor chemical maintenance or exposure to the sun.

Jet inserts and valves do not qualify for labor coverage. These parts can be purchased or exchanged under warranty at your authorized Marquis Spas® dealer. Gaskets and seals are not covered under the warranty.

The control system in your Marquis spa will automatically circulate and filter. (See SPA CONTROL OPERATION, ConstantClean™ and SmartClean™ sections.) The sanitation requires minimal effort if done consistently and properly.

To sanitize spa water, three things are required:

1. **BALANCE:** The water must be balanced so the sanitizer can work and spa equipment is protected.
2. **SHOCK:** Shock to oxidize organics and maximize sanitizer efficiency.
3. **SANITIZE:** Maintain a proper level of sanitizer at all times.

UNDERSTANDING WATER BALANCE

Water balance is the interrelation of factors that determine the quality of the spa water. The effectiveness of chemicals and other additives are dependent on all these factors working together or “in balance”. The primary elements to water balance are the calcium hardness, total alkalinity and pH. Always use water treatment products recommended for use in a Marquis spa.

pH Balance

Keeping the pH balanced is the most critical component of water balance. Calcium hardness and total alkalinity act as buffers to stabilize the pH. When they are properly adjusted, the pH will be stable and easy to maintain. The pH is a measure of the relative acidity and basicity of the water. The ideal pH range is 7.4 - 7.6. When the pH falls below 7.2, the water can become corrosive. Low pH can cause damage to metal in the control system and heater, excessive sanitizer consumption, and skin irritation. A pH above 7.8 can be scale-forming and allow metals or minerals in the water to form deposits and stain spa surfaces. pH above 7.8 can also cause eye and skin irritation.

Total Alkalinity

Alkalinity acts as a buffer to prevent the pH from changing as other substances are added to the water. Stability of the pH is directly related to the alkalinity. The alkalinity should be between 80 - 140 ppm. Alkalinity below 80 ppm makes it difficult to stabilize the pH. Alkalinity above 140 ppm may increase the pH and cause cloudy water, scaling, and decreased efficiency of the sanitizer.

Note: *Alkalinity & pH Increase* and *Alkalinity & pH Decrease* will affect both the pH and alkalinity. Generally, smaller additions will change the pH and have a very minor effect on the alkalinity. Larger additions will also affect the pH, but will have a much greater effect on the alkalinity. (Example: If the pH is very high and the alkalinity is within range, adding a few smaller doses of *pH and alkalinity Decrease* instead of one large dose will reduce the pH with little effect on the alkalinity.)

Calcium Hardness

Do not use soft water in your spa. It is critical to have calcium in your water. The ideal range of calcium is between 200 – 300 ppm. The calcium hardness is normally adjusted when filling or refilling after draining the spa. High calcium levels can cause scale buildup on spa surfaces and equipment. Your spa can be protected against high calcium by using *Metal & Stain Remover* per the directions on the container. Low calcium levels can cause spa water to become highly corrosive and damaging to the equipment components and plumbing. To raise calcium levels, use *Calcium Hardness Increase*.

BALANCE

When initially filling or refilling your spa, follow these steps to achieve proper water balance.

IMPORTANT! Always follow instructions on the chemical container when adding chemicals.

1. Test the spa water using a test strip or test kit. Determine the pH and alkalinity of the water.
2. If adjustments are needed for the pH and/or alkalinity, always balance the alkalinity before balancing the pH. The product(s) you should use to adjust pH and/ or alkalinity are *pH Alkalinity Increaser* or *pH & Alkalinity Decreaser*. Make any additions per the directions on the bottle and then test and repeat if necessary until all readings are in the desired range.
3. Increase the calcium hardness if necessary.

SHOCK

Initial Treatment

Shock the spa using granular *Chlorine Sanitizer* or non-chlorine *Spa Shock*. Add directly to the spa per the instructions on the container. For the initial treatment, *Chlorine Sanitizer* is preferred as it will also establish a residual of sanitizer.

Maintenance Treatment

Once bacteria and other wastes are neutralized by the sanitizer, they stay in the water unless oxidized or shocked. Often called chloramines or bromamines, they create dull, cloudy water and can cause odor and eye or skin irritation. Shock treatment rids your spa of these wastes for clear, sparkling water. Shocking with non-chlorine *Spa Shock* or granular *Chlorine Sanitizer* is recommended once a week or whenever the water appears dull or cloudy or has a strong odor. Non-chlorine *Spa Shock* allows use of the spa 15 minutes after shock treatment.

NOTE: A strong bromine or chlorine odor typically indicates the spa needs to be shocked – not that there is too much bromine or chlorine in the water. A properly balanced spa that is shocked regularly will not have an odor.



SANITIZE

ConstantClean™ System (option)

The ConstantClean™ system utilizes a combination of sanitizers to increase water quality and significantly decrease maintenance. The combination of a *Spa Frog® Mineral Cartridge** and the factory installed ozonator greatly reduce the amount of sanitizer required. Instead of the normal 3 - 5 ppm of bromine, you may only need to maintain 1 - 2 ppm of bromine.

NOTE: The use of *Spa Frog® floating cartridges* is recommended. Do not use other floating chemical dispensers or Biguanide. Damage to the spa shell and other internal components can occur.

* The built-in sanitation system is not available in some international markets. However, the ozone system is available on all spa models in all countries. Please see your dealer for recommended alternate treatment method if the built-in sanitation system is not available.

BUILT-IN SANITATION SYSTEM*

After shocking the spa water with *Chlorine Sanitizer* granules or non-chlorine *Spa Shock*, bring the spa water to operating temperature. Then install the *Spa Frog® cartridges*.

ADJUST THE MINERAL CARTRIDGE

Remove the protective cellophane wrap from the *Spa Frog® mineral cartridge*. While holding the bottom of the cartridge, turn the top until the number six appears in the setting window.

NOTE: The mineral cartridge should be replaced every three to four months. You will still feel the "spent" minerals inside, but they are no longer effective and the cartridge needs to be replaced. It is recommended to drain and refill the spa at the same time you replace the mineral cartridge.

ADJUST THE BROMINE CARTRIDGE

Remove the protective cellophane wrap from the *Spa Frog® bromine cartridge*. Finding the right setting for the bromine cartridge will require monitoring your usage for the first few weeks. Begin with an initial setting based on the chart below and monitor bromine levels daily for the first week or so, adjusting the cartridge by one setting per day until a 3 - 5 ppm level has been achieved. To adjust cartridge, remove from system and turn to the next highest setting if the bromine level is low or the next lower setting if the bromine level is high. The bromine cartridge needs to be replaced when empty between two and four weeks. Always maintain 3 - 5 ppm of bromine.

Suggested Initial Bromine Cartridge Settings

Daily filter time	Spa Gallons		
	250-300	300-400	400-500
One hour	2	3	4
Two hours	2	2	3
Four hours	1	2	2

INSTALL THE CARTRIDGES

Locate and remove the cartridge holder cap on the top lip of the spa. Push down and turn the holder counterclockwise to unlock. Lift holder out. Snap the *Spa Frog® mineral cartridge* into the area of the holder marked "MINERALS" (top portion), making sure to line up the indentation near the top of the cartridge with the raised line on the holder. Then snap the *Spa Frog® bromine cartridge* into the area of the holder marked "BROMINE". Be sure to line up the indentation on the cartridge with the raised line on the holder. After cartridges are snapped in, return the holder, push down, and then turn clockwise to lock into place. Replace the cap.

CAUTION: Hand-tighten only; avoid over tightening; avoid bending the holder to help prevent damage to the holder. Damage caused due to improper removal or installation of chemical cartridge holder is not covered under the warranty. Cartridge holder is warranted to be free from defects at time of delivery of spa. Chemical cartridge holders do not qualify for labor coverage. These parts can be purchased or exchanged under warranty at your authorized Marquis Spas® dealer.

REMOVE THE CARTRIDGES

Reverse above procedures to remove cartridges.

*The built-in sanitation system is not available in some international markets. See your authorized Marquis Spas® dealer for recommended alternate water treatment method.

WATER CARE REGIMEN

Marquis SpaCare™ products are classified by easy to follow usage guidelines. The information below indicates whether the product should be used daily, weekly, monthly, when filling, or as needed – if special water conditions arise.

DAILY

Sanitizer

Maintain 1 - 2 ppm of bromine at all times.

WEEKLY

Spa Shock

Sanitizer combines with bacteria and neutralizes sanitizer/bacteria on contact. However, the used sanitizer/bacteria particle is still present in the spa water. Used sanitizer in the water emits an odor and causes cloudy water. To oxidize, or rid the spa of this used sanitizer, you must shock the spa once a week. **NOTE:** Additional shocking may be necessary if the spa is under heavy use.

AS NEEDED PRODUCTS

pH & Alkalinity Increase

pH & Alkalinity Decrease

These two products work to raise or lower the pH and alkalinity in the spa. They are only needed if the test strip indicates the levels are not in the ideal ranges.

Water Clarifier

Microscopic particles can pass through the spa filter and create cloudy water. The use of *Marquis SpaCare™ Water Clarifier* combines these microscopic particles into larger particles that can be trapped in the filter to clear cloudy water.

Spa Defoamer

If foam appears in your spa, the action of the jets will keep it from dissipating. The use of *Marquis SpaCare™ Spa Defoamer* instantly rids your spa water of foam.

Metal and Stain Remover

Metal and Stain Remover will remove metals such as iron and copper from spa water.

WATER CARE TROUBLESHOOTING GUIDE

NOTE: If you request a service call and no problem is found with the spa or the problem is not covered by warranty (i.e. chemical damage), you will be charged at the regular service rate.

- P: Problem
- S: Solution

Cloudy Water

- P: Inadequate filtration or dirty filter.
- S: Ensure that the filter is securely installed. Clean or replace filter. Increase the length of clean up and/or filter cycles.

- P: Water is not balanced.
- S: Test water and adjust pH, alkalinity, and sanitizer as needed. Shock to oxidize and destroy organics in the water.

- P: Unfiltered particles or chemically saturated.
- S: Use *Water Clarifier* to combine particles.

- P: High total dissolved solids
- S: Drain, clean, and refill the spa.

Chemical Odor

- P: Too many chloramines/bromamines in the water.
- S: Treat water with *Spa Shock*, then adjust sanitizer level as necessary.

- P: Dull looking water, difficult to manage. High total dissolved solids (TDS) may be the cause.
- S: Drain, clean and refill with fresh water.

Musty Odor

- P: Not enough sanitizer in water – bacteria or algae in water.
- S: Add sanitizer as necessary and shock. Readjust sanitizer level if necessary.

Yellow Water

- P: Low pH and/or low alkalinity.
- S: Test and adjust pH with *pH and Alkalinity Increase*. Adjust alkalinity if necessary.

Foaming

- P: High concentration of body oils, lotions or soaps, as well as excessive organics.
- S: Use *Spa Defoamer* and adjust pH and sanitizer as needed.

Scum Line in Spa

- P: Body oils and dirt.
- S: Use *Glove Sponge* to clean the spa. Test and adjust the sanitizer and pH if necessary. Increase the clean up cycle.

No Sanitizer Reading

- P: Sanitizer level is too low.
- S: Shock and/or adjust *Spa Frog® bromine cartridge* until the sanitizer registers in the recommended range.

- P: Test strip remains “white” even after sanitizer has been added.
- S: Sanitizer level could be extremely high. It can bleach the reagents on the test strip and give a false reading. Remove spa cover and activate jets and air control. Allow jets to run for 30 minutes. Test water to see if desired level has been reached. Adjust *Spa Frog® bromine cartridge* to reduce bromine level.

High Sanitizer Reading

- P: Too much chlorine or bromine added or dispensed into the spa.
- S: Remove spa cover and activate jets and air control. Allow jets to run for 30 minutes. Test water to see if desired level has been reached. Adjust *Spa Frog® bromine cartridge* to reduce bromine level.

Eye or Skin Irritation

- P: Contaminants or excessive amount of chloramines/bromamines in water.
- S: Treat water with *Spa Shock*. Adjust sanitizer level.

- P: pH is low.
- S: Adjust as needed.

Corrosion of Metal

- P: Low pH.
- S: Adjust pH with *pH and Alkalinity Increase*.

Green Water/Algae

- P: Low sanitizer level or high pH.
- S: Adjust pH, shock and/or adjust *Spa Frog® bromine cartridge* as necessary.

Erratic pH

- P: Alkalinity and/or calcium hardness are too low causing pH “bounce”.
- S: Test and adjust alkalinity and/or calcium hardness to bring them into the ideal range.

WEEKLY MAINTENANCE

Removing Debris

Remove any debris and leaves from the Vortex skimmers and suction guard(s) on the inside of the spa. Blocked intakes can impede the flow of water through the jetting system.

Water Level

Replenish the water level if necessary so that it is approximately two-thirds up the Vortex skimmer opening. (See STARTING YOUR SPA.) Low and high water levels can damage your spa. It is important to check your water level often.

MONTHLY MAINTENANCE

Filter Care

We cannot stress enough the importance of a clean filter for proper water filtration. Dirty filters can restrict water flow, cause hazy water, and prevent your chemicals from working properly. Dirty filters can also cause low flow from jets, poor water clarity and sensors to activate error codes. It is important to clean filters regularly. Many water treatment products clear or clarify the water by clumping microscopic particles and minerals together so that these larger particles can be effectively trapped in the filter. A filter clogged with debris and calcium deposits does not trap particles properly. Soak your filter cartridges in *Filter Cleaner* monthly.

The Maintenance Reminder on the spa-side control panel indicates a CL every 30 days to remind you to clean your filter.

Removing the Filter

Turn off the spa breaker. Grasp the edge of the Vortex skimmer lid, waterfall or tray, pull up firmly, but gently, to remove it.

Turn the filter cartridge counterclockwise to unscrew it from its base. Lift out the filter cartridge.

Use a hose to clean the filter cartridge and *Filter Cleaner* to soak the filters.

NOTE: Keep an extra set of filters on hand so you always have a clean set ready for immediate spa enjoyment. Remember to replace the filter cartridges at least once a year.

Reinstalling the Filter

Repeat the steps above in reverse. Do not overtighten the filter as it may cause the threads on the bottom to strip and fail to hold the filter in place. When replacing the Waterfall, center the top over the raised filter ring and press down firmly until the top snaps into place. (See INSTALLATION INSTRUCTIONS, Filter Cartridges.)

CAUTION: Overtightening of the filter can cause the filter or filter housing to crack. Tighten filter until it is just snug.

NOTE: Filters and filter lids do not qualify for labor coverage. These parts can be purchased or exchanged under warranty at your authorized Marquis Spas® dealer.



Leakage Detection

Open the equipment door and check for signs of water leakage around the pump(s). Pump seals wear out over time, especially with improper water chemistry. Early detection of pump seal failure can significantly reduce repair costs. Pump seals, heater gaskets and pump gaskets must be checked each month to ensure they are not leaking. Further damage caused by a leak from any component is not covered under the warranty.

EVERY THREE TO FOUR MONTHS

Draining and Filling the Spa

The average spa needs to be drained every three to four months. After months of continually adding chemicals to the water and introducing body oils and lotions, the water can be difficult to manage and chemicals are not as effective as usual. You may also notice excessive foaming. More frequent draining may be required depending on use.

Draining the Spa

1. Turn off the power to the spa.
2. Open the equipment compartment (see EQUIPMENT DIAGRAM). Remove the hose bib cap from the connection and attach a hose.
3. Open the drain valve. Gravity causes the water to drain out of the hose.
4. When the spa is empty, close the drain valve and remove the hose. Reinstall the hose bib plug.

NOTE: Keep the drain valve closed at all times except when draining the spa (do not rely on the cap to stop the flow of water). Not doing so could result in damage to the drain valve due to freezing water.

Ozonator (option) Operation

Clean the ozone injector and fitting every six months. A mineral build up may clog the ozone injector, causing a lack of flow or low flow of ozone. To prevent this, perform the following:

1. Disconnect power to the spa.
2. Open the equipment compartment.
3. Locate the ozonator in the equipment compartment (see spa equipment diagrams) and unplug the ozonator from the control box.
4. Place 16 oz. of white vinegar (white vinegar will not damage the spa components) into a container such as a cup or bucket. Place the container on the equipment compartment floor.
5. Carefully loosen the long clear tube to the bottom of the ozonator. A liquid substance may be found inside the tubing. If it is present, be certain not to come into contact with the liquid.
6. **WARNING:** Nitric acid accumulates in the air lines of the ozonator and injector. Nitric acid will cause severe chemical burns if direct skin contact is made, so always wear protective gloves, glasses and clothing when working on the ozonator or injector lines. To prevent inhalation or ingestion of the nitric acid, DO NOT blow or inhale with your mouth to any of the adapters, fittings or tubing of the ozonator or injector air lines.



7. Place the end of the tubing into the vinegar, making certain that the end of the tubing sits at the bottom of the container.
8. Reconnect power to the spa.
9. Run the spa until all of the vinegar is gone. This should allow an ample low of vinegar to be run through the injector and clear the blockage.
10. Disconnect power to the spa.
11. Remove the empty cup or bucket.
12. Reinstall the tubing to the bottom of the ozonator.
13. Plug the ozonator into the control box.
14. Close the equipment compartment door.
15. Reconnect power to the spa.

Replacing the Mineral Cartridge

The *Spa Frog® mineral cartridge* should be replaced every three to four months. You may still feel the “spent” minerals inside, but they are no longer effective and need to be replaced. (See ADJUST THE MINERAL CARTRIDGES, Blue Mineral Cartridge.)

Clean the DuraShell® Interior

Once the spa is drained, clean the DuraShell interior thoroughly – especially at the water line. We suggest the *Glove Sponge* to clean without scratching.

Bleach (diluted) is the recommended cleaning agent for DuraShell – other products should be avoided except as stated below.

To maintain the high gloss and elegant look of DuraShell®, just follow these simple steps: For normal care and cleaning use a soft cloth or sponge and water. Rinse well and dry with a soft, clean cloth. Never use abrasive cleaners. Do not allow your acrylic surface to come into contact with products such as ketones or esters such as acetone or ethyl acetate (nail polish remover), Wintergreen oil (methyl salicylate), nail polish, dry cleaning solution or other chlorinated organic solvents, lacquer thinners, gasoline, aromatic solvents, citrus cleaners, pine oil, etc. Remove dust and dry dirt with a soft, damp cloth. Clean grease, oil, paint and ink stains with diluted isopropyl (rubbing) alcohol (do not let alcohol pool or remain on acrylic). Dry with a clean, soft cloth. Avoid using razor blades or other sharp instruments that might scratch the surface.

NOTE: Due to the high-gloss, fine finish of the acrylics, imperfections in the surface texture may occur. These in no way compromise the integrity of the spa shell.

NOTE: Do not leave an empty spa uncovered. Direct sunlight on the spa surface can cause severe damage or blemishing and can result in the voiding of any surface warranties.

Refill the Spa

Fill the spa with fresh water from a garden hose and balance the water as described in the Water Treatment section. The use of a *Fill Filter* is recommended when filling especially in areas of high mineral content in the water. Attach to the end of a garden hose to filter out any grit and sediment that could accumulate in the spa and potentially scratch the spa surface.

AS NEEDED MAINTENANCE

Cover Care

It is recommended that you use Marquis *Cover Cleaner* to keep the Dura-Cover™ clean and conditioned. Proper care of the cover increases the life and keeps it looking great in even the harshest conditions. **NOTE:** Do not use regular household products or products that contain silicone, alcohol, steel wool, or bleach.

1. Remove the cover from the spa and gently lean it against a wall or fence.
2. Use a garden hose to spray the cover and loosen and rinse away dirt or debris.
3. Use a large sponge and/or soft bristle brush with a very mild soap solution. Scrub the vinyl top in a circular motion. Rinse vinyl clean before a soap film has a chance to dry.
4. Scrub the perimeter of the cover and side flaps. Rinse clean with water.
5. Rinse off underside of cover with water only (no soap) and wipe clean with a dry rag.
6. Use *Cover Cleaner* to condition the top of the cover after cleaning.

Cushioned Headrest Care

To increase the life of your cushioned headrest, remove and replace them with care only when necessary.

Remove Cushioned Headrest

Slip your fingers under each end of the interior cushioned headrest part and gently pull straight towards you. Damage caused to attachments due to improper removal is not covered under warranty. Pillows and attachments are warranted to be free of defects at delivery only.

DuraWood Care

Clean the exterior of the spa with a mild soap and water solution. Cleaners that contain alcohol or high levels of solvents, along with Acetone, Nitrobenzene, and Cyclohexanol, can dissolve and discolor the DuraWood exterior.

Excess Debris

Grit and debris tracked into the spa should be removed with a spa vacuum.

Water Line

To avoid buildup of oils and lotions at the water line, clean the interior weekly or when needed. We suggest the Glove Sponge to clean without scratching.

NOTE: Do not use the same brush or sponge to clean the exterior of the spa and the interior of the spa. Soap and other product residue used on the outside of the spa can cause foaming of the spa water and scratches to the spa surface if used on the inside of the spa.

Light Bulb Replacement:

1. Turn off the power to the spa.
2. Remove the equipment area door to find the light access. (See EQUIPMENT DIAGRAM.)
3. Remove the lamp socket from the back of the light assembly by turning counterclockwise and pulling at the same time.
4. Gently pull the bulb out of the lamp socket and replace it with a 6 watt bulb only (GE #918) available from your spa dealer.
5. Install the lamp socket back into the light assembly and replace door.

SUSPENDED USE OR WINTERIZING THE SPA

If you decide to discontinue the use of your spa for any extended period of time, we suggest you follow the steps below.

NOTE: During long periods of inactivity, damage can occur to equipment from condensation within the equipment compartment. Failure to follow these instructions during freezing conditions will result in cracked fitting(s) and glue joints, and other damage.

1. Turn off the power to the spa.
2. Drain the spa. (See DRAINING AND REFILLING THE SPA.)
3. Remove all residual water from the seating and footwell. If necessary, bail out the remaining water then dry the spa with towels. A wet/dry vacuum is recommended for best results.
4. Using the wet/dry vacuum, place vacuum nozzle over each jet nozzle to remove water from plumbing lines, starting with the highest jet and finishing with the lowest jet. **NOTE:** The spa is equipped with a Tri-Zone control which is used to divert water between different jet zones. The valve must be "open" to the particular jets you are vacuuming.
5. Unscrew the pump plug(s) from the pump(s). (See STARTING YOUR SPA.)
6. Again, using the wet/dry vacuum, place nozzle over the exposed pump opening(s) to remove excess water. The pump(s) should be removed from the spa and stored in a climate-controlled room.
7. Clean the spa interior.
8. Clean the filter cartridges.
9. Reinstall the DuraCover™ and lock in place. **NOTE:** Direct sunlight on the spa surface can cause severe damage or blemishing and can result in the voiding of any surface warranties.

VACATION CARE INSTRUCTIONS**Short time periods: 3-5 days**

1. Adjust the pH (see WATER CARE).
2. Sanitize the water by following the shock procedures (See WATER CARE).
3. Lock your spa cover in place with cover locks.
4. Upon return, shock sanitize water.

Long time periods: 5-14 days

1. One day before leaving, set the temperature to its lowest level (approximately 80°F, 27°C).
2. Adjust pH as needed.
3. Shock sanitize water.
4. Upon return, shock sanitize water.
5. Return temperature to original setting.
6. Test water chemistry and adjust as necessary.

MARQUIS SPAS® LIMITED WARRANTY

What the Marquis Corp. Limited Warranty Covers

Marquis Corp. warrants that our products will be free from defects in materials and workmanship for the term set forth exclusively in this warranty.

Accessories purchased from Marquis Corp. or a Marquis Corp. authorized Marquis Spas® dealer and added to the spa after manufacture of the spa are not covered under this warranty but may have other warranties. Refer to owner's manual for proper use, maintenance and installation of your spa. The Marquis Spas® Limited Warranty, provided by this Owner's Protection Plan, is made only to the original purchaser of the spa and is not transferable.

[10] STRUCTURE

The reinforced structure is warranted for **10** years not to leak. Fittings and attachments are not included.

[7] SURFACE

The acrylic surface is warranted for **seven** years against blisters, cracks and delamination.

[5] PLUMBING

Plumbing and fittings are warranted against water loss for **five** years. Warranty coverage does not include gaskets or seals.

[5] EQUIPMENT

Electronic equipment is warranted against defects in materials and workmanship for **five** years. Equipment includes equipment packs, PC boards, pumps, control panels, heater and heat sensors. Adagio™ audio system, DVD unit and associated components have a separate warranty.

[5] EXTERIOR

The synthetic skirt and DuraBase exterior are warranted against cracking and peeling for **five** years.

[2] COMPONENTS

The ozonator, GFCI and IR/RF sensors are warranted against defects in material and workmanship for **two** years

[1] PARTS

LED lights, remote controls, valves, spa cover, jet inserts, in-line sanitation system and overlays are covered for **one** year. These parts do not qualify for labor coverage under this warranty.

Fuses, non-LED lights, wood exterior, filter, filter lid, cushioned headrests, chemical cartridge holders and other items not specifically mentioned in this warranty are warranted to be free from defects in materials and workmanship at time of delivery. These parts do not qualify for labor coverage under this warranty.

Term of the Marquis Corp. Limited Warranty

The term of your warranty begins on the date the product is sold to you and continues for the term described in this warranty for each component.

What You Should Do if You Experience a Problem

Unless otherwise designated in writing by Marquis Corp., Marquis Corp. or its agent are the only parties authorized to perform warranty service on Marquis Corp. spas. Upon experiencing a problem, please contact your authorized Marquis Spas® dealer.

You will be asked to provide the following information when requesting warranty service: your name, address and contact information; serial number; a description of your spa and a description of the problem. You may be required to provide proof of purchase of your spa prior to receiving warranty service.

What Marquis Corp. Will Do in the Event of a Problem

Marquis Corp. agrees to repair any plumbing or surface defects and to repair or furnish a replacement for any factory-installed component covered under this warranty which, upon test and examination by Marquis Corp., proves to have manufacturing defects. All materials for examination must be returned to Marquis Corp. freight prepaid.

Marquis Corp. will provide parts and labor (according to predetermined schedule) at no charge to repair or replace components that fail due to manufacturing defects. Responding authorized Marquis Spas® dealer may charge additional service and travel fees.

In the event that Marquis Corp. or its agent determines that your problem can be addressed by providing a replacement part to you for installation in your spa, a replacement part will be provided to you at no charge when you return the defective part. All replacement parts assume the original warranty status of the spa into which they are installed, including time remaining on warranty, and have no separate or independent warranty of any kind.

To facilitate repairs, Marquis Corp. or its agent may require access to spa equipment. It is your responsibility to provide unencumbered access.

What the Marquis Corp. Limited Warranty Does Not Cover

No warranty will apply to any spa that has been (i) modified, altered or adapted without Marquis Corp.'s written consent; (ii) maltreated or used in a manner other than in accordance with the spa Owner's Manual; (iii) repaired by any third party not authorized by Marquis Corp.; (iv) improperly installed by any party; (v) used with equipment not covered by this warranty, to the extent that problems are attributable to such use; (vi) relocated to the extent that problems are attributable to the relocation; and (vii) located on any support surface other than specified in the spa printed instructions. Refer to instructions in the owner's manual for proper use, maintenance and installation of your spa.



Other items not included in this warranty are freight expenses; labor and material cost associated with removal and or replacement of the spa; damage to or fading of the spa surface and staining of the spa surface or equipment caused by impact, scratching, abrasive or corrosive cleaners; damage due to extreme water temperatures outside the range of 32°F to 120°F (0°C to 49°C) under any circumstances; or damage to the spa surface or equipment caused by acts of nature, including wind and power surges. Damage to the spa surface and fittings caused by leaving the spa uncovered and empty of water with direct exposure to sunlight may cause solar heat distress and also invalidates this warranty.

Other costs not associated with the direct repair of the spa, such as phone charges and missed work are not included in this warranty. In the event that the Marquis Corp. serial number tag on the spa has been removed or tampered with, the warranty will be void. Customer may not dismantle spas, and any attempt to dismantle systems, other than described herein, constitutes a modification or alteration of the spa which voids the applicable warranty.

LIMITATIONS

Your sole and exclusive remedy and Marquis Corp.'s entire liability in connection with manufacture and sales of its spa products is repair or replacement (at Marquis' option) of a defective part, as expressed in the limited warranty. Any other express or implied representation or warranty, including the implied warranties of merchantability and of fitness for a particular purpose as well as non-infringement, is excluded to the maximum extent permitted by law.

Except as may be required by applicable law, Marquis Corp. shall not be liable for injury, loss, or damage to person or property, however arising, in connection with manufacture or sale of its spa products. This includes indirect, punitive, special, incidental, or consequential damages (including but not limited to loss of use) whether the claim for such injury, loss, or damage is based on breach of contract, breach of warranty, or tort, even if Marquis Corp. has previously been advised of the possibility of such damages.

This limited warranty gives you specific legal rights, and you may also have other rights which vary from state to state.



ADAGIO™ AUDIO SYSTEM AND AQUAVISION ONE YEAR LIMITED WARRANTY

Marquis Corp. warrants to the original retail purchaser, the components of the Adagio™ audio system or Aquavision unit will be free from defects in material and workmanship for a period of one year from date of purchase. One year coverage includes parts. Labor is covered for 90 days and is based on a predetermined schedule. Optional remote and IR/RF sending unit not included in this warranty; other warranties may apply from the original manufacturer of the optional remote. The Adagio™ audio system and Aquavision unit Limited Warranty is made only to the original purchaser of the spa and is not transferable.

In no event shall any obligation of Marquis Corp. extend beyond the original period of any applicable warranty determined according to the effective warranty date of the original purchaser.

PERFORMANCE OF WARRANTY

Marquis Corp. agrees to repair or furnish a replacement for any defects in Adagio™ audio system or Aquavision unit material or workmanship which upon test and examination by Marquis Corp. proves defective. Adagio™ audio components including CD player/radio, speakers, subwoofer, mechanical speaker lift device, stereo access door, power supply are warranted against defects in material and workmanship for one year. Aquavision components including mechanical monitor lift device, monitor housing and power supply are warranted against defects in material and workmanship for one year. Labor to replace audio or Aquavision components is covered for 90 days. Water intrusion of any kind is not covered. All materials for examination must be returned to Marquis Corp. freight prepaid.

Your authorized Marquis Dealer reserves the right to assess travel charges for service calls.

INVALIDATION OF WARRANTY

This warranty is void if the Adagio™ audio system or Aquavision unit has been subjected to alteration, misuse or abuse or if any repairs on the Adagio™ audio system or Aquavision unit are performed or attempted by anyone other than an authorized Marquis Corp. service center. Alteration is defined as any component change, electrical conversion or the addition of any alternative sound system components which contribute to component failure.

Misuse and abuse shall include without limitation any external power source attached to the Adagio™ audio system or Aquavision unit other than approved source, or use in a particular manner that the Adagio™ audio system or Aquavision unit was not designed, or operation of the Adagio™ audio system or Aquavision unit other than in accordance with Marquis Corp. printed instruction (located in the Owner's Manual) that leads to any component failure. Under no circumstances shall Marquis Corp. or any of its representatives be held liable for injury to any person or damage to any property, however arising.

Other costs not associated to the direct repair of the spa, such as phone charges, missed work, and damage caused to the Adagio™ audio system or Aquavision unit beyond Marquis control, are not included in this warranty. Items beyond Marquis control include but are not limited to damage resulting from: improper connections, accidents, failure to follow procedures defined in the Owner's Manual, damaged from excessive wattage to the system, lightning, extreme temperatures or any other natural occurrences.

ADAGIO™ AND AQUAVISION LIMITED WARRANTY

IMPORTANT: Some jurisdictions do not allow the exclusion or limitation of incidental or consequential damages, therefore the limitation or exclusions may not apply to you.

DISCLAIMERS

There are no additional warranties, express or implied, which extend beyond the terms of this limited warranty. Marquis Corp. makes no warranty of merchantability of the goods or the fitness of the goods for a particular purpose.

No other person or entity has been authorized to make any warranty, representation or promise of performance not included in this express written warranty, and Marquis Corp. shall not be bound by any such additional warranty, representation or promise.

This warranty gives you specific legal rights. You may also have other rights that may vary from state to state.